



'H' Series Two Valve Manifolds

Catalog 4190-PM





















- aerospace
- climate control
- electromechanical
- filtration
- fluid & gas handling
- hydraulics
- pneumatics
- process control
- sealing & shielding

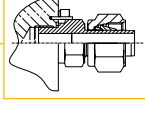

ENGINEERING YOUR SUCCESS.

'H' Series Two Valve Manifolds

Contents

<p>Page 3 Introduction</p>	
<p>Page 4/5 Valve assembly details</p>	 
<p>Page 6/7 Remote mount static pressure manifolds</p>	 
<p>Page 8/9 High pressure remote manifolds</p>	 
<p>Page 10/11 Direct mount static pressure manifolds</p>	 
<p>Page 12/13 Single and double flanged outlet manifolds</p>	 
<p>Page 14 B31.1 compliant power plant manifolds</p>	 
<p>Page 15 PTFree connections</p>	 
<p>Page 16/17 Mounting brackets</p>	 
<p>Page 18 Materials</p>	
<p>Page 19-20 Spares kits and options</p>	
<p>Page 21 Complementary Products</p>	 

'H' Series Two Valve Manifolds

Introduction

With many years of manifold development and manufacture Parker Hannifin are able to offer the most comprehensive range of two valve block and bleed manifolds to suit all types of instrumentation installations, specifications and applications.

Now consolidated into one catalogue, selection can be made from a comprehensive range of bodies with a variety of connections and valve positions, optimising installation and access opportunities.

Designed to reduce installation costs and improve safety performance, the consolidation of valves into one unit provides you with a combination of instrument isolation together with bleed/vent and test facilities.

In addition to manufacturing manifolds Parker also produce a comprehensive range of single and twin ferrule high integrity tube fittings. Manufactured in a variety of materials these products are used extensively in the oil, gas, petro-chem, power, processing and many other markets.

By integrating these products, instrument manifolds and tube fittings, Parker can offer unique connection combinations which are specifically designed to eliminate site assembled threaded connectors, ingress of debris and contamination from thread sealant materials which often result in instrument failure, replacement and downtime. Eliminating the use of taper threads, factory assembled and tested connections will ensure improved performance through simpler assembly and installation procedures. This system provides total flexibility of tubing position with positive leak proof connections.

Continuous product development may from time to time necessitate changes in the details contained in this catalogue. Parker Hannifin reserve the right to make such changes at their discretion and without prior notification.



All dimensions shown in this catalogue are approximate and subject to change.

WARNING

FAILURE, IMPROPER SELECTION OR IMPROPER USE OF THE PRODUCTS AND/OR SYSTEMS DESCRIBED HEREIN OR RELATED ITEMS CAN CAUSE DEATH, PERSONAL INJURY AND PROPERTY DAMAGE.

This document and other information from Parker Hannifin Corporation, its subsidiaries and authorized distributors provide product and/or system options for further investigation by users having technical expertise. It is important that you analyze all aspects of your application and review the information concerning the product or system in the current product catalog. Due to the variety of operating conditions and applications for these products or systems, the user, through its own analysis and testing, is solely responsible for making the final selection of the products and systems and assuring that all performance, safety and warning requirements of the application are met.

The products described herein, including without limitation, product features, specifications, designs, availability and pricing, are subject to change by Parker Hannifin Corporation and its subsidiaries at any time without notice.

Offer of Sale

The items described in this document are hereby offered for sale by Parker Hannifin Corporation, its subsidiaries or its authorized distributors. Any Order accepted by Parker Hannifin will be subject to our terms and conditions of sale, copy available on request.

'H' Series Two Valve Manifolds

Standard manifold globe style bonnet design

1. POSITIVE HANDLE RETENTION DESIGN FEATURING BROACHED SQUARE ENGAGEMENT POSITIONED BY THREAD LOCKED GRUB SCREW.

2. "T" BAR
ERGONOMICALLY DESIGNED FOR EASE OF OPERATION. ANTI-TAMPER AND LOCKABLE DEVICES CAN BE SUPPLIED FOR ON SITE RETRO-FIT.

4. GLAND PACKING ADJUSTER
FOR MAXIMUM PACKING STABILITY AND PERFORMANCE, SIMPLE AND EASILY ADJUSTABLE FOR GLAND WEAR COMPENSATION.

6. VALVE BONNET
STANDARD CONSTRUCTION FOR MAXIMUM PRESSURE RATING WITH REPLACEABLE BONNET SEALING WASHER ARRANGEMENT.

8. THRUST BUSH
ANTI ROTATIONAL ADJUSTOR BUSH ENSURES UNIFORM PACKING COMPRESSION, MAXIMISING PRESSURE TIGHT SEALING AND LIMITING COLD FLOW PASSAGES.

10. BONNET/BODY WASHER
ANNEALED SEALING WASHER TO ENSURE COMPLETE ATMOSPHERIC LEAKAGE AND ALLOWING ON SITE RETRO-FIT OF BONNETS WITH 100% RE-SEALING ASSURANCE

For safe reliable and repeatable performance

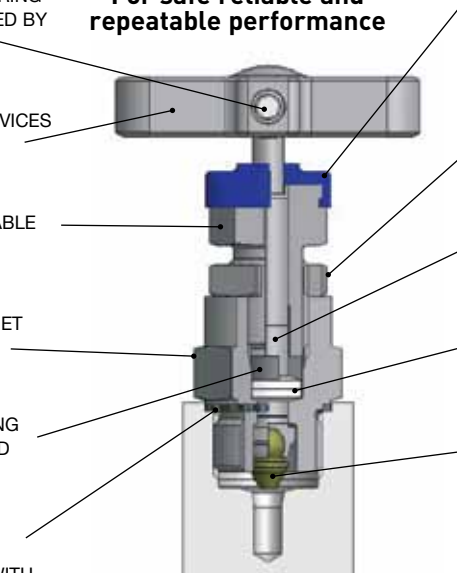

3. DUST CAP
THIS HAS A DUAL PURPOSE, PREVENTING AIR BORN DEBRIS FROM CONTAMINATING THE OPERATING SPINDLE THREAD AND PROVIDING COLOUR CODED FUNCTIONAL IDENTIFICATION. ISOLATE (BLUE) BLEED/TEST (RED).

5. GLAND ADJUSTER LOCK NUT
A SECURE ANTI VIBRATION LOCKING MECHANISM TO PREVENT INADVERTENT GLAND ADJUSTER LOOSENING.

7. ANTI BLOWOUT SPINDLE
DESIGNED FOR LOW TORQUE OPERATION WITH HIGH QUALITY MICRO MIRROR STEM FINISH FOR POSITIVE GLAND SEALING.

9. GLAND PACKING (ADJUSTABLE)
CHEVRON EFFECT DUAL PIECE GLAND PACKING TO PROVIDE MAXIMUM SEALING AREA CONTACT WITH MINIMUM GLAND ADJUSTMENT.

11. SPINDLE TIP
SELF CENTERING, NON-ROTATIONAL TIP GIVES SUCCESSIVE POSITIVE BUBBLE TIGHT SHUT OFF ASSURING THE USER OF LEAKAGE FREE PERFORMANCE AND DOWNSTREAM FUNCTIONAL SAFETY.

All metallic standard parts are produced in stainless steel, for alternative materials please refer to page 18. Manifolds produced in other specified materials will be provided with non-wetted parts as standard in stainless steel, this applies to items 1, 2, 4, 5 & 8.

Specification

- Height closed (standard and HP) = 47mm (1.85")
Height open (standard and HP) = 50.3mm (2.00")
- Number of turns open/close - 3.5
- Stainless steel construction
- Maximum standard pressure up to 6,000 psig (414 barg)
- Maximum optional pressure (limited to HP suffix see page 8/9) up to 10,000 psig (689 barg)
- Temperature rating -54C to +538C (-65F to +1000F)
- PTFE standard gland packing (Graphoil optional)
- Maximum temperature PTFE 260C (500F)
- Maximum temperature Graphoil 538C (1000F)

Features

- Standard unit throughout manifold range
- Operating threads outside washout area
- Externally adjustable gland
- Low operating torque
- Alternative 10,000 psig (689 barg) range available
- Retro-fit kit for:-
Anti-tamper spindle
Panel mounting
Lockable T bar
Handwheel with lockable option
- Bonnet locking pin to prevent accidental removal fitted as standard
- Alternative graphoil packing for high temperature performance available
- Alternative self centering tip materials available for gaseous and aggressive fluids
- Safety back seated spindle prevents stem blowout and provides secondary back up stem seal
- Packing below threads to prevent lubricant washout
- All valves 100% factory tested
- NACE certified wetted parts available
- Optional cleaned and lubricated suitable for Oxygen service
- Heat code traceable body and bonnet

Pressure vs Temperature

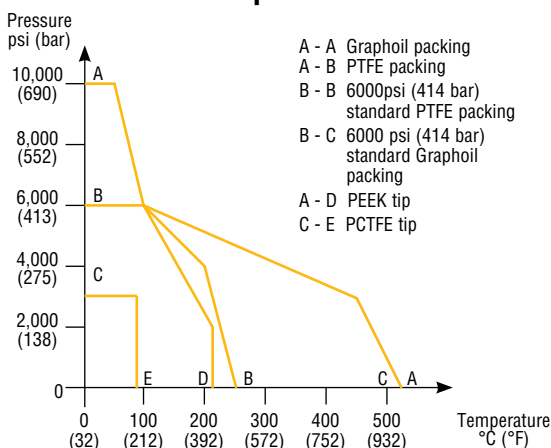

'H' Series Two Valve Manifolds

Optional manifold globe style bonnet design

For on-site assembly

The design options below can be simply retrofit to any "H" series standard manifold. Retrofit kit part numbers are listed next to the illustrated option and all parts will be supplied in stainless steel regardless of the parent body material.

For factory fitted assembly







To obtain factory assembled options the manifold part number must be suffixed with the option and function designator. This allows you to select one or both of the bonnets to be fitted with the selected option or, different options to be fitted to either of the bonnets.

Function designator IS – isolate DR–drain/test.

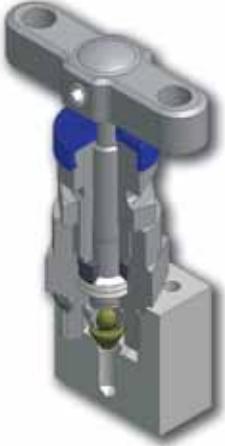
Example HL*2VATDR – manifold with drain/bleed valve (DR) fitted with anti-tamper (AT). Isolate valve will be standard bonnet design.

Example HL*2VHWISTHLDR – manifold with isolate valve fitted with hand-wheel and drain/bleed valve fitted with "T" bar locking mechanism.

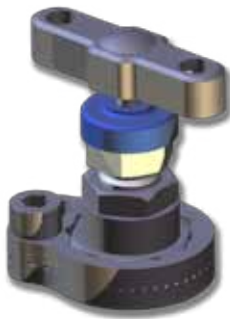
Note: Padlocks for lockable handwheels and "T" bars are not supplied (hole size 6mm/0.24").

Standard bonnet	T bar handle locking	Anti tamper spindle
	 <p>Retro-fit kit part number KITTHL Factory assembled suffix THL</p>	 <p>For key only - part no. ATHKEY/1 Retro-fit kit part number KITATK with key Factory assembled suffix AT without key ATK with key</p>
Handwheel	*Panel mounting	B31.1 Compliant
 <p>Retro-fit kit part number KITHW Factory assembled suffix HW</p>	 <p>Retro-fit kit part number KITPM† Factory assembled suffix PM † Panel mount kit for HP: KITPMHP</p>	 <p>See page 14 for details</p>
Lockable handwheel		
 <p>Retro-fit kit part number KITLHW Factory assembled suffix LHW</p>		

*Panel mounting hole diameter = 26mm (1.02").
Panel thickness = Max 5mm (0.20") Min 2.3mm (.09").

'H' Series Two Valve Manifolds

Remote mount static pressure manifolds

Purpose

This series of two-valve manifolds combine valves into one unitised block to perform isolation, bleed and calibration of pressure transmitters, gauges and switches. Process, instrument and vent connections can be provided in a variety of sizes and thread forms including NPT, BSPT_r and BSPP.



HL*2VTF



HL*2V



HL*2HVSDLH



HAL*2V

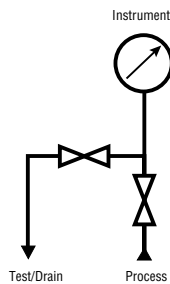

Line diagram represents this group of manifolds



HL*28M8F4F

Instrument double block and bleed manifolds

Double block and bleed instrument manifolds for dual isolating and bleed purposes. Ideal for limited space and panel installations.

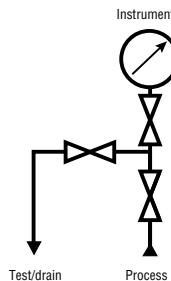

HL*3DBB

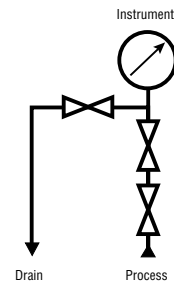

HL*3DBB1

*For material codes see page 18.

For options see pages 19/20.

'H' Series Two Valve Manifolds

Remote mount static pressure manifolds

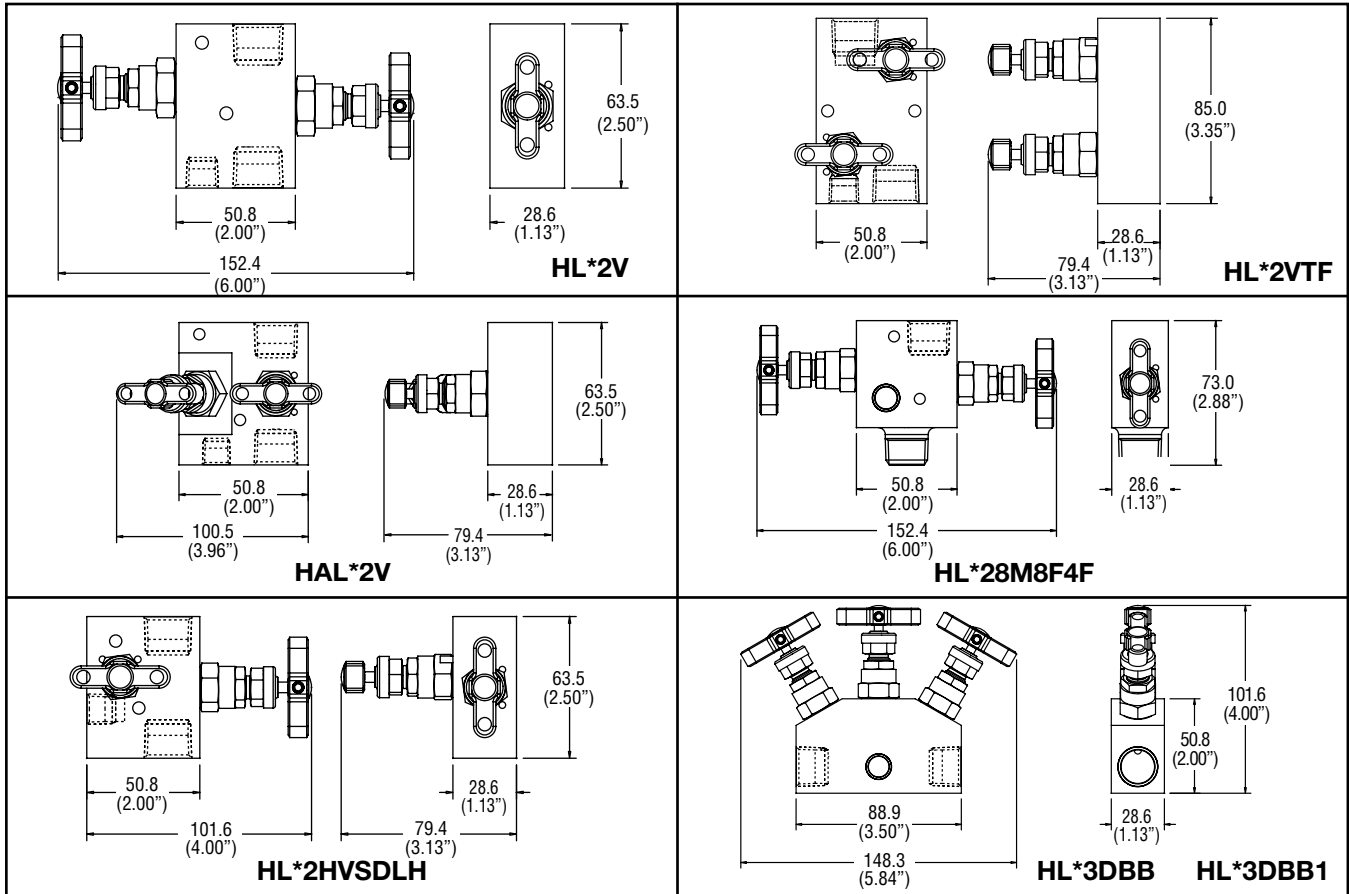

*Overall width with valves fully open

Standard product specification: self centering metal/ metal seat, PTFE packed, stainless steel, T bar handle operation, 6000 psig (414 barg).

Standard range part numbers

Part No	Inlet (NPT)	Standard connections	
		Outlet (NPT)	Bleed/test (NPT)
HL*2V	1/2" female	1/2" female	1/4" female
HAL*2V	1/2" female	1/2" female	1/4" female
HL*2HVSDLH	1/2" female	1/2" female	1/4" female
HL*2VTF	1/2" female	1/2" female	1/4" female
HL*28M8F4F	1/2" male	1/2" female	1/4" female
HL*3DBB	1/2" female	1/2" female	1/4" female
HL*3DBB1	1/2" female	1/2" female	1/4" female

*Insert material designator, see page 18

Function

Blue cap – isolate,
Red Cap – drain/bleed

Specification

- Maximum standard pressure up to 6,000 psig (414 barg), to ANSI Class 2500
- Temperature rating - see page 4
- Standard port sizes up to 1/2" NPT

Features

- Standard high performance bonnet design
- Colour coded valve function identification
- Alternative materials of construction available
- Optional port sizes and thread forms available: BSPT_r, BSPP
- Socket and butt weld connections available
- PTFree connections available (see page 15)
- Blank and bleed plugs available
- NACE certified on request
- Optional cleaned and lubricated suitable for Oxygen service
- Heat code traceable body and bonnet

'H' Series Two Valve Manifolds

High pressure 10,000 psig (689 barg) two valve manifolds

Purpose

This series of manifolds have been designed for more aggressive applications and for operation up to 10,000 psig (689 barg).



HL*2VHP

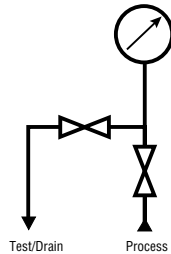

Line diagram represents this group of products



HAL*2VHP



HL*28M8F4FHP

Instrument double block and bleed manifolds

Designed for dual isolating and bleed purposes, ideal for limited space and panel installations.

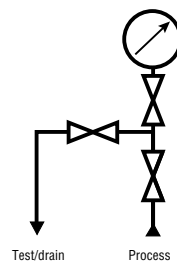

HL*S3DBBHP

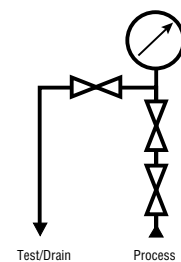

HL*3DBB1HP

*For material codes see page 18.

For options see pages 19/20.

'H' Series Two Valve Manifolds

High pressure 10,000 psig (689 barg) two valve manifolds

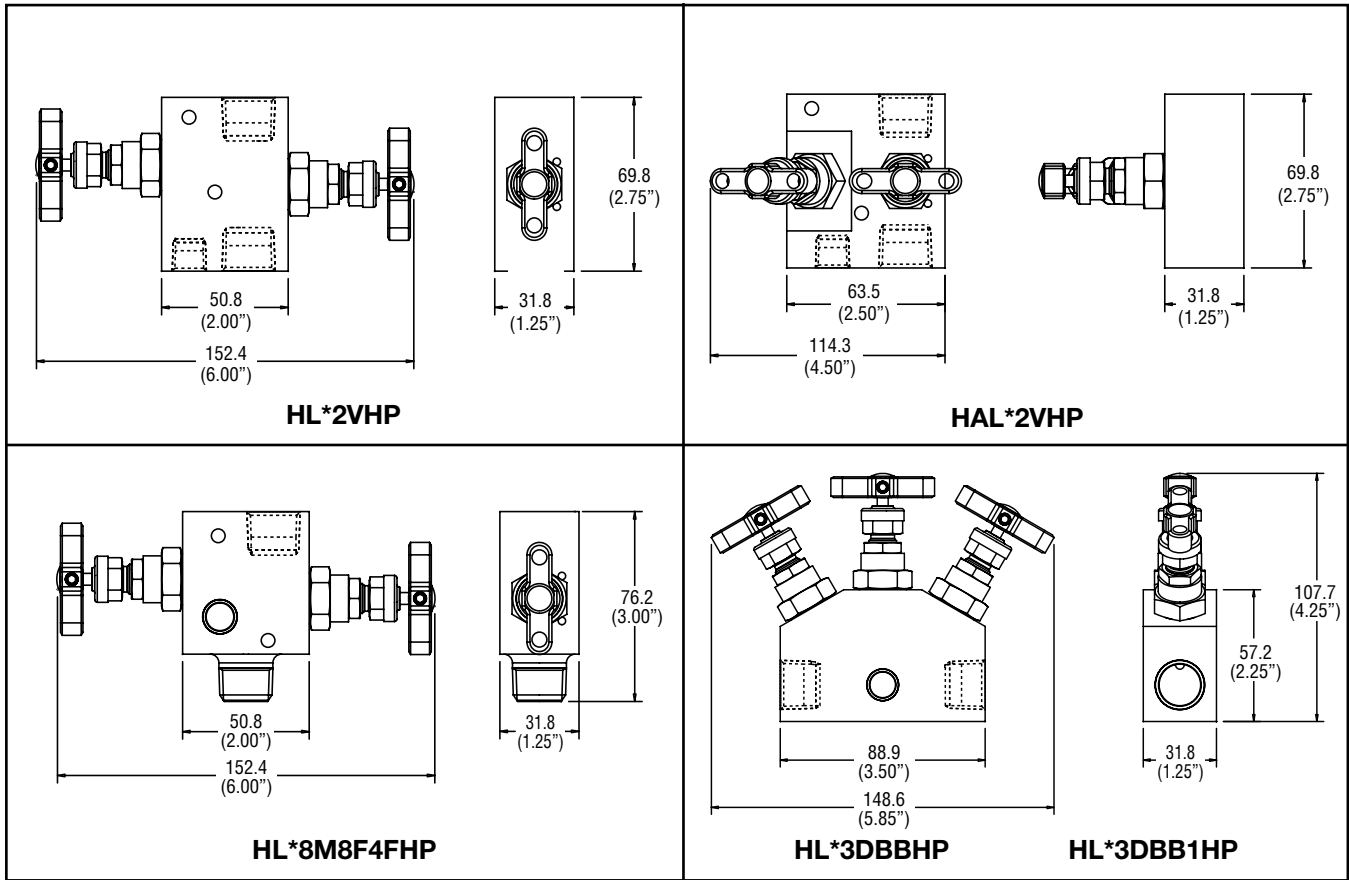

*Overall width with valves fully open

Standard product specification: self centering metal/metal seat, PTFE packed, stainless steel, T bar handle operation, 10,000 psig (689 barg).

Standard range part numbers

Part No	Inlet (NPT)	Standard connections	
		Outlet (NPT)	Bleed/test (NPT)
HL*2VHP	1/2" female	1/2" female	1/4" female
HAL*2VHP	1/2" female	1/2" female	1/4" female
HL*28M8F4FHP	1/2" male	1/2" female	1/4" female
HL*3DBBHP	1/2" female	1/2" female	1/4" female
HL*3DBB1HP	1/2" female	1/2" female	1/4" female

*Insert material designator, see page 18

Function

Blue cap – isolate,
Red Cap – drain/bleed

Specification

- Maximum standard pressure up to 10,000 psig (689 barg), to ANSI Class 4500 (St. St.)
- Temperature rating - see page 4
- Standard port sizes up to 1/2" NPT

Features

- Standard high performance bonnet design
- Colour coded valve function identification
- Alternative materials of construction available
- Optional port sizes and thread forms available: BSPT_r, BSPP
- Socket and butt weld connections available
- PTFree connections available (see page 15)
- Blank and bleed plugs available
- NACE certified on request
- Optional cleaned and lubricated suitable for Oxygen service
- Heat code traceable body and bonnet

'H' Series Two Valve Manifolds

Direct mount static pressure manifolds

Purpose

This series of two valve manifolds is designed for direct mounting to process measurement pressure transmitters. Standard functions include isolation, test, bleed and calibration.



HD*2EXT
Base entry enclosure mountable



HD*2HLHFF
Straight through bolted flange



HEF*2LH

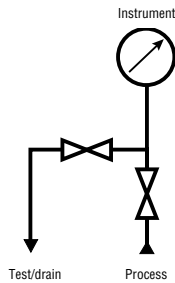

Line diagram represents this group of products



HD*2HLH



HEF*2LH8N



HD*2HLHCP
For Model 3051 transmitter

*For material codes see page 18.

For options see pages 19/20.

'H' Series Two Valve Manifolds

Direct mount static pressure manifolds

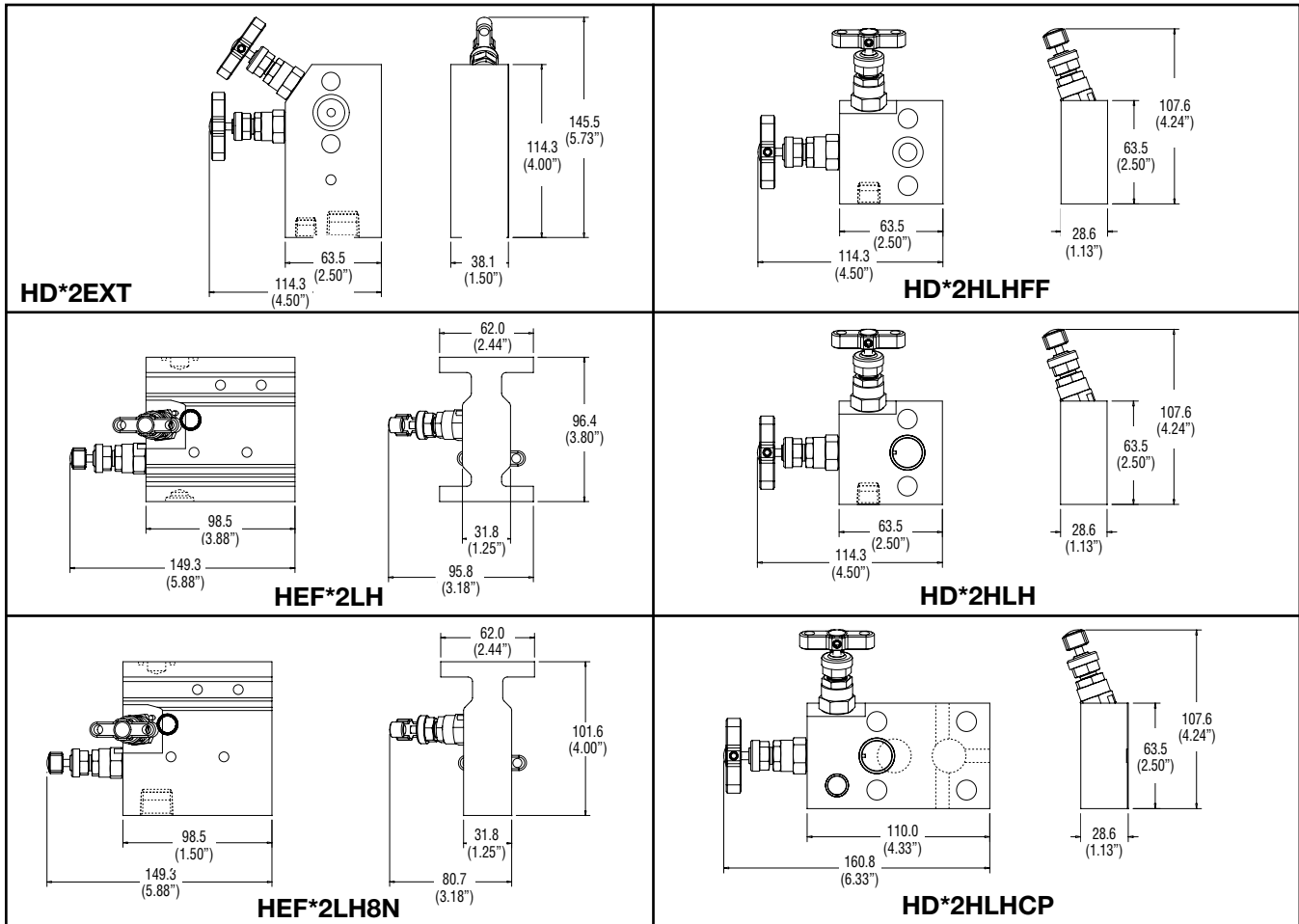

Overall width with valves fully open

Standard specification: self centering metal/metal seat, PTFE packed, stainless steel, T bar handle operation, 6000 psig (414 barg). Supplied as standard with 1 off PTFE instrument seal and appropriate 7/16" UNF high tensile zinc plated carbon steel bolts.

Standard range part numbers

Part No.	Inlet (NPT)	Standard connections	
		Outlet	Drain/bleed
HD*2EXT	1/2" female	Flanged	1/4" female
HEF*2LH	Flanged	Flanged	1/4" female
HEF*2LH8N	1/2" female	Flanged	1/4" female
HD*2HLHFF	Flanged	Flanged	1/4" female
HD*2HLH	1/2" female	Flanged	1/4" female
HD*2HLHCP	1/2" female	Flanged	1/4" female

*Insert material designator

Function

Blue cap – isolate,
Red Cap – drain/bleed

All manifolds are drilled suitable for bracket mounting - standard manifold support brackets are available.

Straight through flow pattern rising plug valves are available for HEF*2LH and HEF*2LH8N.

*For material codes see page 18. For options see pages 19-20.

Specification

- Maximum standard pressure up to 6,000 psig (414 barg), to ANSI Class 2500
- Temperature rating - see page 4
- Standard port sizes up to 1/2" NPT

Features

- Standard high performance bonnet design
- Colour coded valve function identification
- Alternative materials of construction available
- Optional port sizes and thread forms available: BSPTr, BSPP
- Socket and butt weld connections available
- PTFree connections available (see page 15)
- Blank and bleed plugs available
- NACE certified on request
- Optional cleaned and lubricated suitable for Oxygen service
- Heat code traceable body and bonnet

'H' Series Two Valve Manifolds

Flanged connected static pressure manifolds

Purpose

These manifolds are designed for fast and efficient installation and removal of pressure measurement instruments. Single kidney flange arrangements are provided with optional inlet connections for total installation flexibility, the redundant connection can also be used for purge operations.

The dual flanged model enables users to mount two pressure measuring devices connected to a common inlet, redundant cross-hole connections can be used for process purging.

Kidney flange connections can also be provided with male threaded outlet, A-LOK®, CPI™ or PTFree connections. Closing the isolation valves and operating the bleed valve gives operators the opportunity of venting trapped pressurised fluids to an environmentally safe area. Further access through the bleed connection enables in-situ instrument calibration.



HL*2V1KFMB

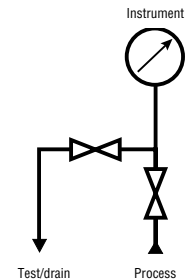

HL*2V2KFMB

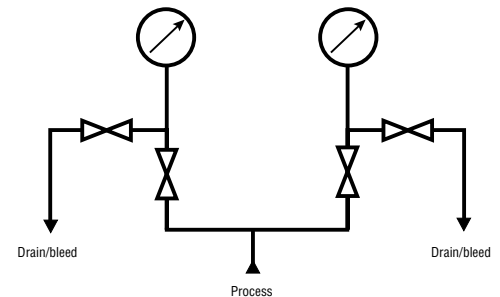

All manifolds are drilled suitable for bracket mounting - standard manifold support brackets are available.

*For material codes see page 18. For options see pages 19-20.

'H' Series Two Valve Manifolds

Standard dimensions

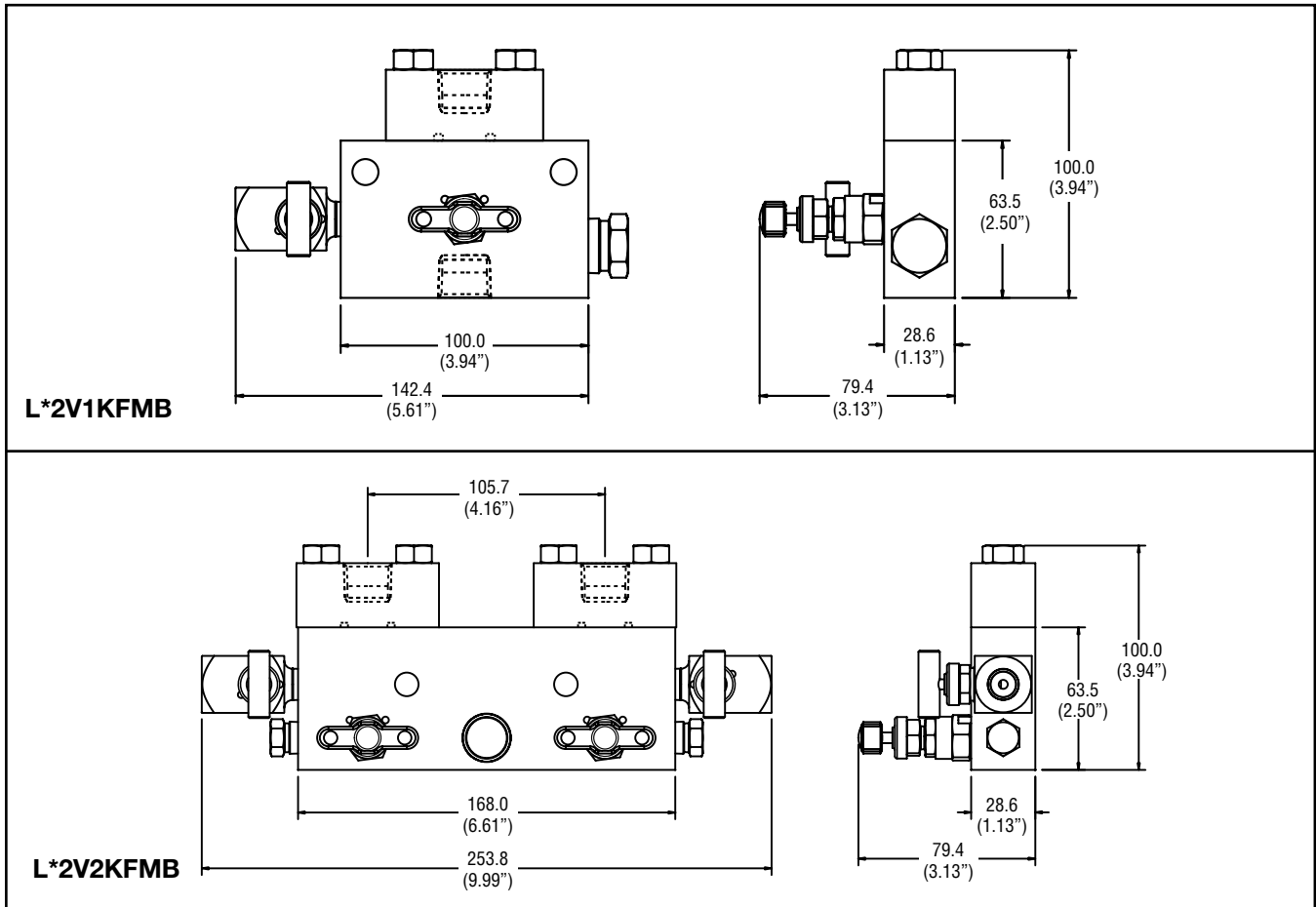

Overall width with valves fully open

Standard product specification: self centering metal/metal seat, PTFE packed, stainless steel construction, T bar handle operation, 6000 psig (414 barg). Bleed valves fitted with Fluorocarbon Rubber gland seals.

Standard range part numbers

Part No.	Inlet (NPT)	Standard connections	
		Outlet	Bleed/test (NPT)
L*2V1KFMB	2 x 1/2" female	1 x Flanged x 1/2" female	1/4" female
L*2V2KFMB	1/2" female	2 x Flanged x 1/2" female	1/4" female

*Insert material designator

Function

Blue cap – isolate,
Red Cap – drain/bleed

*For material codes see page 18. For option codes see pages 19-20.

Specification

- Maximum standard pressure up to 6,000 psig (414 barg), to ANSI Class 2500
- Temperature rating -40C to +204C (-40F to +400F)
- Standard port sizes up to 1/2" NPT

Features

- Standard high performance bonnet design
- Colour coded valve function identification
- Alternative materials of construction available
- Optional port sizes and thread forms available: BSPT_r, BSPP
- Socket and butt weld connections available
- PTFree connections available (see page 15)
- Blank and bleed plugs available
- NACE certified on request
- Optional cleaned and lubricated suitable for Oxygen service
- Heat code traceable body and bonnet
- Mini bleed valves for compact installation

'H' Series Two Valve Manifolds

Power plant products - compliant with ANSI B31.1

H Series Hand valves & manifolds

Designed and developed from our highly successful H series valves. These products meet the requirements of both ANSI B31.1 (Power plants) and B31.3 (Petrochemical plants), including the materials of construction.

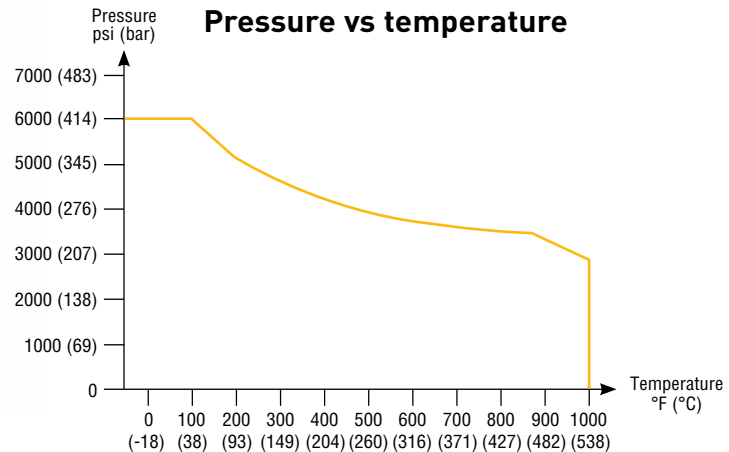

Features

- All valves are graphite packed for high temperature service
- Non rotating, hard stem tip with metal to metal seating for bubble tight shut-off
- Back seat design
- Blow-out proof stem
- Pressures & temperatures in accordance with ASME class 2500
- Patented Tru-Lok safety bonnet locking device prevents accidental removal
- Standard orifice 4mm (Cv 0.35)

Specific pressure / temperature performance

316 SS 6000 psig @ 100°F (414 bar @ 38°C)
 2915 psig @ 1000°F (201 bar @ 538°C)

Plus a range of manifolds:



Part numbering & Product range offered:

For H series valves and manifolds use CAT4190HV; CAT4190PM; CAT4190FM then replace the prefix 'H' with 'HPP'. Eg: HNVS8FF becomes HPPNVS8FF3

Product range:

HPPNVS; HPPGV; HPPBSNVS2; HPPLS2V; HPPLS2HVSDLH; HPPALS2V; HPPLS3M; HPPLS5M; HPPDS2HLH; HPPDS3M; HPPDS5M; HPPEFS2/3/5

Consult factory or come and see us about other options.

'H' Series Two Valve Manifolds

PTFree connect™

Manifold connections

Many users continually desire the elimination of taper threads and their associated sealant.

The PTFree connect™ system enables users to assemble tube lines to any of the manifold ports without the need for PTFE tape or other liquid sealant.

The PTFree connection can be applied to any of the manifold featured in this catalogue. these will be factory fitted, pin locked and pressure tested.

PTFree connect™ enables angled tube connections to be swivelled until the optimum tube alignment position has been achieved. Assembly to the tube connector is achieved by tightening the standpipe nut one-quarter turn from the finger tight position.

Manifolds can also be supplied with male connectors using the same thread form as the PTFree connect™. They can be provided factory fitted, pin locked and tested before they leave our manufacturing plant.

Some size restrictions may be necessary due to the close proximity of some connections and the across flat hexagon dimensions, as a guide PTFree connect™ for inlet and outlet can be up to 1/2" or 12mm o/d., drain/bleed connections should be restricted to 1/4" or 6mm. For PTFree male connectors inlet and outlet should be restricted to 3/8" or 10mm and 1/4" or 6mm o/d for drain/bleed.

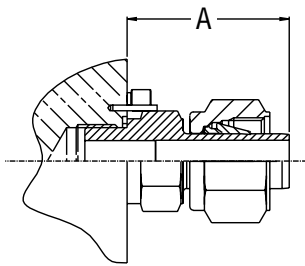

A = 29.70mm (1.17") 6mm/1/4" tube
 A = 35.00mm (1.38") 10mm tube
 A = 35.00mm (1.38") 3/8" tube

**PTFree connect™
(Code FRC)**

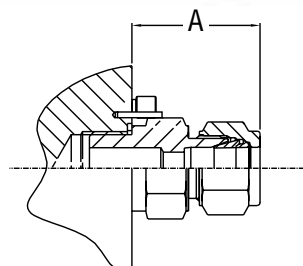

A = 31.50mm (1.25") 6mm/1/4" tube
 A = 36.60mm (1.44") 10mm tube
 A = 36.60mm (1.44") 3/8" tube

**PTFree male connectors
(Code FRCM)**

Part Number Construction Examples

				Inlet, Outlet, Drain/vent/test, tube size/thread size & form		
Manifold Part No. + option	Connection Style FRC or FRCM	A-LOK®(L) or CPI™(B) L or B	Metric or inch tube M or I	Inlet (E) + size	Outlet (X) + size	Drain/vent/test
HLS2V	FRC	L	M	E12	X12	D6
Part No. HLS2VFRCLME12X12D6 = 2 valve manifold with all A-LOK PTFree connect™ Inlet 12mm, Outlet 12mm Drain/vent/test 6mm. Stainless steel standard construction						
HALS2V	FRCM	B	I	E6	X6	D4N
Part No. HALS2VFRMCMBIE6X6D6N = 2 valve manifold with CPI™ PTFree male connector Inlet 3/8 o.d, Outlet 3/8 o/d Drain/vent/test 1/4" NPT. Stainless steel standard construction						

'H' Series Two Valve Manifolds

Manifold bracket support

Purpose

It is essential to fully support impulse/pressure measurement tubing lines, manifolds and instruments. All Parker manifolds are designed to accommodate bracket mounting and support, a full range of brackets with additional U bolts are available.

Brackets are designed for panel and wall mounting and give full clearance for ease of handle operation. They are also suitable for vertical and horizontal positioning on 2" pipe-stand.

Standard brackets are produced from 4mm thick carbon steel plate to provide maximum rigidity and support. For full corrosion protection the brackets are shot blasted and zinc sprayed.

Alternative bracket material is available upon request.

Part No. BKT1CS

Simple to install bracket for horizontal/vertical 2" stanpipe, wall, panel or base mounting, bracket stand-off prevents handle obstruction.

Suitable for: -

HL*2V
HL*28M8F4F
HAL*2V
HL*2HVSDLH
(Not suitable for HP versions)

For 'U' bolts suffix part no. with B.
Example BKT1CSB

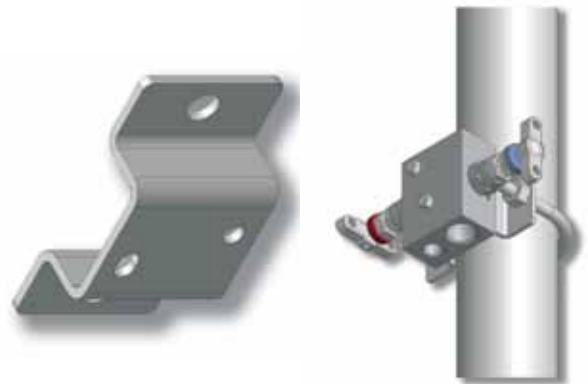
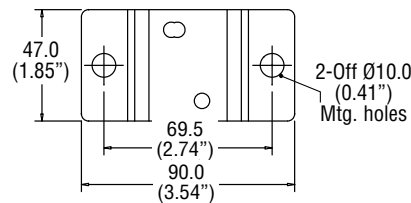
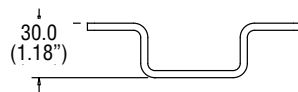

For manifold/bracket bolts add 'bolt set' suffix from matrix.

Example: Bracket, 'U' bolt and manifold/bracket bolts BKT1CSB1 (suitable for H*L2V).

Part No. BKT2CS

Universal manifold mounting bracket suitable for all remote mount manifolds. This bracket allows 90 degree positioning enabling total installation flexibility and prevents handle obstruction

Suitable for the above manifolds and: -

HL*2VTF
HL*3DBB
HL*3DBB1
HAL*2VHP

Suitable for all HP versions

For 'U' bolts suffix part no. with B
Example BKT2CSB

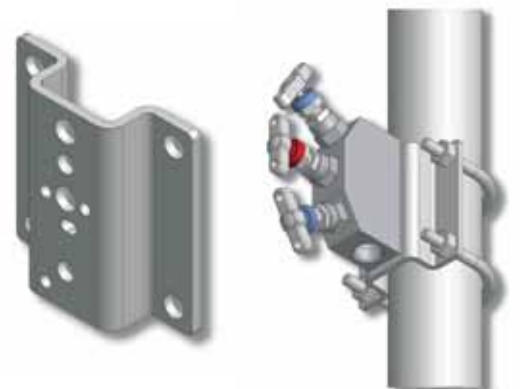
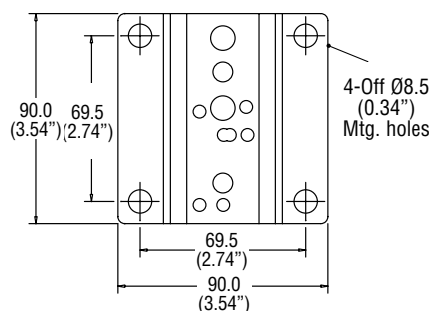
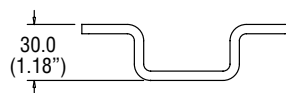

For manifold/bracket bolts add bolt set suffix from matrix.

Example: Bracket, 'U' bolt and manifold/bracket bolts BKT2CSB2 (suitable for HL*3DBB).

'H' Series Two Valve Manifolds

Manifold bracket support

Part No. BKT3CS

Suitable for: -

HD*2HLH
HD*2HLHCP
HD*2HLHFF

For 'U' bolts suffix part no. with B
 Example BKT3CSB

For manifold/bracket bolts add bolt set suffix from matrix.
 Example: Bracket, 'U' bolt and manifold/bracket bolts BKT3CSB3 (suitable for HD*2HLH).

Universal manifold mounting bracket suitable for all direct mount manifolds. This bracket design enables horizontal or vertical instrument positioning.

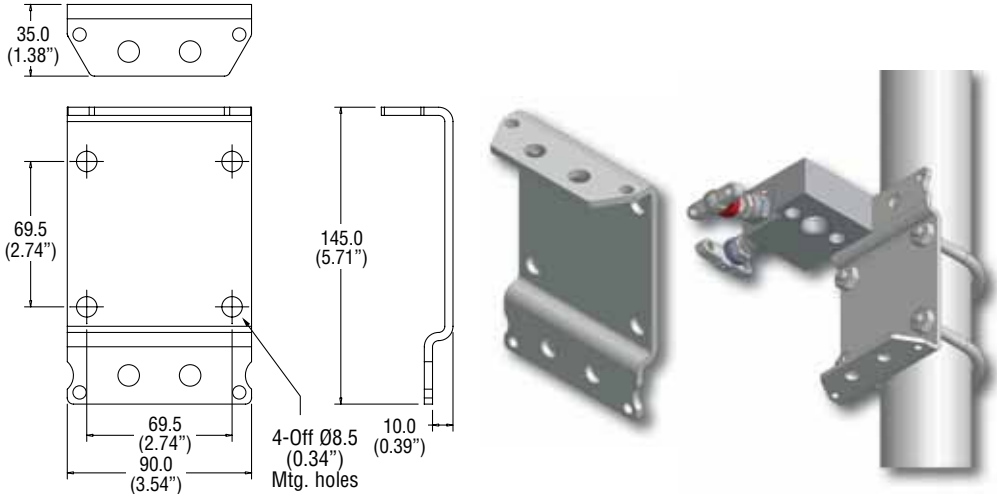

Part No. BKT4CS

Suitable for: -

HEF*2LH8N
HEF*2LH

For 'U' bolt suffix part no. with B
 Example BKT4CSB

For manifold/bracket bolts add bolt set suffix from matrix.
 Example: Bracket, 'U' bolt and manifold/bracket bolts BKT4CSB4 (suitable for HEF*2LH).

For extruded style manifold blocks providing full base support for horizontal or vertical fixing to 2" pipestand.

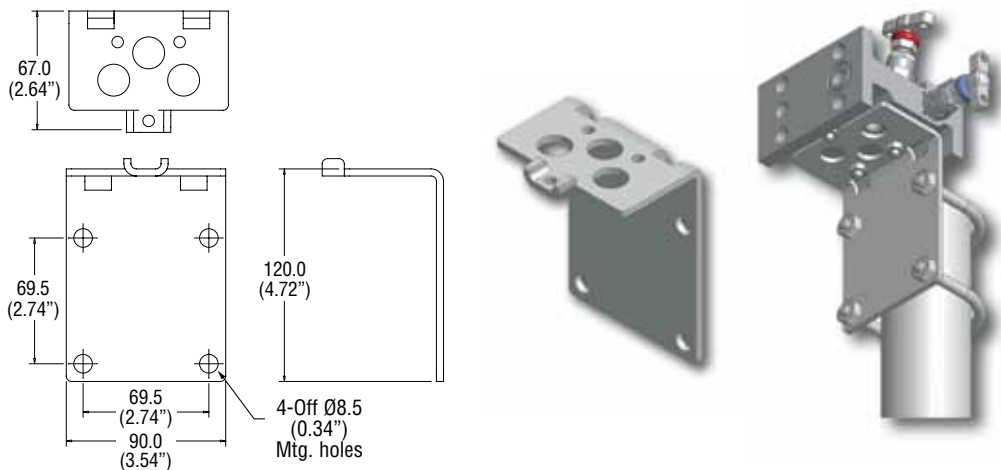

'U' Bolt with nuts & washers for 2" NB standpipe

Part No. UBACS

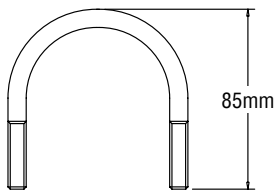

Carbon steel standard



Manifold/bracket bolts c/w nuts and washers.

Manifold Part No.	Bolt Set	Part No.	Suffix
HL*2V	M5 x 45 Bolt	BS1	1
HAL*2V	M5 x 45 Bolt	BS1	1
HL*28M8F4F	M5 x 45 Bolt	BS1	1
HL*2HVSDLH	M5 x 45 Bolt	BS1	1
HL*2VTF	M5 x 45 Bolt	BS1	1
HL*3DBB	M10 x 14 Bolt	BS2	2
HL*3DBB1	M10 x 14 Bolt	BS2	2
HD*2HLH	M6 x 14 Bolt (1-OFF) M10 x 14 Bolt (1-OFF)	BS3	3
HD*2HLHFF	M6 x 14 Bolt (1-OFF) M10 x 14 Bolt (1-OFF)	BS3	3
HD*2HLHCP	M10 x 14 Bolt (2-OFF)	BS2	2
HEFS2LH	M6 x 45 Bolt	BS4	4
HEFS2LH8N	M6 x 45 Bolt	BS4	4

All nut and bolt sets are standard in Carbon Steel

'H' Series Two Valve Manifolds

Material options

Material		Manifold types			
		HL*2V	HL*28M8F4F	HL*2HVSDLH	HD*2HLHFF
		HAL*2V	HL*2VTF	HL*3DBB	HD*2HLHCP
*Insert code for selected material in part number		page 6	page 6	page 6	page 10
Stainless steel Std	S	✓	✓	✓	✓
Monel	M	✓	✓	✓	✓
Duplex	D1	✓	✓	✓	✓
Super Duplex	D2	✓	✓	✓	✓
Hasteloy	HC	✓	✓	✓	✓
Carbon Steel	C	✓	✓	✓	✓
6Mo	6MO	✓	✓	✓	✓
Titanium	T	✓	✓	✓	✓
Incoloy 825	825	✓	✓	✓	✓
Inconel 625	625	✓	✓	✓	✓

All non-wetted parts ie those not in contact with the process medium will be supplied in stainless steel.
High pressure versions can be supplied in any of the above materials.

Material		Manifold types			
		HEF*2LH	HD*2EXT	HL*2V1KFMB	B31.1 compliant Power Plant
		HEF*2LH8N	HD*2HLH	HL*2V2KFMB	
*Insert code for selected material in part number		page 10	page 10	page 12	page 14
Stainless steel Std	S	✓	✓	✓	✓
Monel	M		✓	✓	
Duplex	D1		✓	✓	
Super Duplex	D2		✓	✓	
Hasteloy	HC		✓	✓	✓
Carbon Steel	C	✓	✓	✓	✓
6Mo	6MO		✓	✓	
Titanium	T		✓	✓	
Incoloy 825	825		✓	✓	
Inconel 625	625		✓	✓	

All non-wetted parts ie those not in contact with the process medium will be supplied in stainless steel.

'H' Series Two Valve Manifolds

Available options				Page	6/7	6
Suffix adding sequence	Function	Option Detail	Part No. suffix	HL*2V+HP	HAL*2V+HP	
1	Gland packing	Graphoil	3	✓		
2	Seating	PCTFE (207 bar/3000 psi)	9	✓		
		PEEK	PK	✓		
		Note 1 Rising plug valve style PTFE packed	RP			
		Stellite tip	ST	✓		
3	Plug/Bleed valve (supplied loose in box)	Blank plug 1/4 NPT	P	✓		
		Bleed valve 1/4 NPT	BV	✓		
4	Connection and bolting	Note 2 Socket weld (* insert pipe size)	SW*NB	✓		
		Note 2 Butt weld (* insert pipe size)	BW*NB	✓		
		Note 3 DIN 19213 sealing grooves	DIN†			
		BSPT (*insert pipe size (e.g. 8K = 1/2"))	*K	✓		
		Note 4 BSPP (*insert pipe size (e.g. 8R = 1/2"))	*R	✓		
		St. St. Mounting bolts	SSB			
		M10 x 1.5 CS Mounting bolts	CSB10			
		M10 x 1.5 St. St. Mounting bolts	SSB10			
		Front face drain 1/4" NPT	FFD			
		Bolts for 3051 inclusive flange	CSBCP			
Swivel gauge outlet (**insert size/thread N=NPT)	**SG		✓			
5		Connection size for tubing	See below			
6	Operating mechanism (See page 5 for details)	Lockable T bar	THL	✓		
		Anti tamper spindle	AT	✓		
		Anti tamper spindle & key	ATK	✓		
		Handwheel	HW	✓		
		Lockable handwheel	LHW	✓		
7	Mounting	Note 5 Assembled to bracket	BRK	✓		
8	Condition	NACE (latest issue)	NACE	✓		
		Cleaned and lubricated for oxygen use	OXY	✓		
		Firesafe	FS	✓		
		Note 6 Heat code trace certificates	HCT	✓		
		Test certificates	TC	✓		
		Air testing	PT	✓		

Note 1 Seat material RP=standard acetal, RP9 = PTFE, RPPK = PEEK.

Note 2 For tube socket or tube butt weld use 1/16 inch denominations and change NB to TB. For metric tube size use actual metric (mm) dimensions e.g. SW12MMTB.

Note 3 Insert seal type 'B1', 'B2', 'B3'.

Note 4 For BSPP connections drain/bleed will be 1/8 BSPP.

Note 5 Bracket will include 'U' bolt & manifold/bracket bolts.

Note 6 Heat code traceable certificates for body and bonnet.

'H' Series Two Valve Manifolds

5/7	6/7	10/11	10/11	10/11	12/13	14	
HL*28M8F4F+HP	HL*2HVSDLH	HEF*2LH	HD*2EXT	HD*2HLHFF	HL*2VIKFMB		
HL*2VTF	HL*3DBB/1+HP	HEF*2LH8N	HD*2HLH	HD*2HLHCP	HL*2V12KFMB	B31.1 compliant Power Plant	Option Detail
✓	✓	✓	✓	✓	✓	STD	Graphite
✓	✓	✓	✓	✓	✓		PCTFE
✓	✓	✓	✓	✓	✓		PEEK
✓	✓	✓	✓	✓	✓		Rising plug valve style PTFE packed
✓	✓	✓	✓	✓	✓	✓	Stellite tip
✓	✓	✓	✓	✓	✓		Blank plug 1/4 NPT
✓	✓	✓	✓	✓	✓		Bleed valve 1/4 NPT
✓	✓	✓	✓	✓	✓	✓	Socket weld *insert pipe size
✓	✓	✓	✓	✓	✓	✓	Butt weld * insert pipe size
✓	✓	✓	✓	✓	✓	✓	DIN 19213 sealing grooves
✓	✓	✓	✓	✓	✓	✓	BSPT (*insert pipe size (e.g. 8K = 1/2"))
✓	✓	✓	✓	✓	✓	✓	BSPP * pipe size (e.g. 8R = 1/2"))
✓	✓	✓	✓	✓	✓	✓	St. St. Mounting bolts
✓	✓	✓	✓	✓	✓	✓	M10 x 1.5 CS Mounting bolts
✓	✓	✓	✓	✓	✓	✓	M10 x 1.5 St. St. Mounting bolts
✓	✓	✓	✓	✓	✓	✓	Front face drain 1/4" NPT
✓	✓	✓	✓	✓	✓	✓	Bolts for 3051 inclusive flange
✓	✓	✓	✓	✓	✓	✓	Swivel gauge outlet (**insert size/thread N=NPT)
✓	✓	✓	✓	✓	✓	✓	See below
✓	✓	✓	✓	✓	✓	✓	Lockable T bar
✓	✓	✓	✓	✓	✓	✓	Anti tamper spindle
✓	✓	✓	✓	✓	✓	✓	Anti tamper spindle & key
✓	✓	✓	✓	✓	✓	✓	Handwheel
✓	✓	✓	✓	✓	✓	✓	Lockable handwheel
✓	✓	✓	✓	✓	✓	✓	Assembled to bracket
✓	✓	✓	✓	✓	✓	✓	NACE (latest issue)
✓	✓	✓	✓	✓	✓	✓	Cleaned and lubricated for oxygen use
✓	✓	✓	✓	✓	✓	✓	Firesafe
✓	✓	✓	✓	✓	✓	✓	Heat code trace certificates
✓	✓	✓	✓	✓	✓	✓	Test certificates
✓	✓	✓	✓	✓	✓	✓	Air testing

Accessories spares

Description	Part number	Box Quantity
PTFE manifold/instrument seals	HKITPTFESEALS	2
Graphoil manifold/instrument seals	HKITGRAPHOILSEALS	2
Isolate valve with PTFE gland, metal seat	HBNTS*ISPTFE	1
Drain/bleed valve with PTFE gland, metal seat	HBNTS*DRPTFE	1
Isolate valve with graphoil gland, metal seat	HBNTSISGRAP	1
Drain/bleed valve with graphoil gland, metal seat	HBNTSDRGRAP	1

*Insert 9 for PCTFE seat

*Insert PK for PEEK

'H' Series Two Valve Manifolds

Parker Instrumentation now offers a wide range of complimentary products.



Pressure Gauge Accessories



Diaphragm Seals



Mechanical Pressure Measurement



Condensate Pots



Electrical Temperature Measurement



Parker grade tubing

Please contact the Instrumentation division or one of our many distributors for more information on our range of complimentary products.

Parker Worldwide

AE – UAE, Dubai

Tel: +971 4 8875600
parker.me@parker.com

AR – Argentina, Buenos Aires

Tel: +54 3327 44 4129

AT – Austria, Wiener Neustadt

Tel: +43 (0)2622 23501-0
parker.austria@parker.com

AT – Eastern Europe, Wiener Neustadt

Tel: +43 (0)2622 23501 970
parker.easteurope@parker.com

AU – Australia, Castle Hill

Tel: +61 (0)2-9634 7777

AZ – Azerbaijan, Baku

Tel: +994 50 2233 458
parker.azerbaijan@parker.com

BE/LX – Belgium, Nivelles

Tel: +32 (0)67 280 900
parker.belgium@parker.com

BR – Brazil, Cachoeirinha RS

Tel: +55 51 3470 9144

BY – Belarus, Minsk

Tel: +375 17 209 9399
parker.belarus@parker.com

CA – Canada, Grimsby, Ontario

Tel +1 905-945-2274
ipd_canada@parker.com

CH – Switzerland, Etoy

Tel: +41 (0) 21 821 02 30
parker.switzerland@parker.com

CN – China, Shanghai

Tel: +86 21 5031 2525

CZ – Czech Republic, Klecany

Tel: +420 284 083 111
parker.czechrepublic@parker.com

DE – Germany, Kaarst

Tel: +49 (0)2131 4016 0
parker.germany@parker.com

DK – Denmark, Ballerup

Tel: +45 43 56 04 00
parker.denmark@parker.com

ES – Spain, Madrid

Tel: +34 902 33 00 01
parker.spain@parker.com

FI – Finland, Vantaa

Tel: +358 (0)20 753 2500
parker.finland@parker.com

FR – France, Contamine s/Arve

Tel: +33 (0)4 50 25 80 25
parker.france@parker.com

GR – Greece, Athens

Tel: +30 210 933 6450
parker.greece@parker.com

HK – Hong Kong

Tel: +852 2428 8008

HU – Hungary, Budapest

Tel: +36 1 220 4155
parker.hungary@parker.com

IE – Ireland, Dublin

Tel: +353 (0)1 466 6370
parker.ireland@parker.com

IN – India, Mumbai

Tel: +91 22 6513 7081-85

IT – Italy, Corsico (MI)

Tel: +39 02 45 19 21
parker.italy@parker.com

JP – Japan, Fujisawa

Tel: +(81) 4 6635 3050

KR – South Korea, Seoul

Tel: +82 2 559 0400

KZ – Kazakhstan, Almaty

Tel: +7 7272 505 800
parker.easteurope@parker.com

LV – Latvia, Riga

Tel: +371 6 745 2601
parker.latvia@parker.com

MX – Mexico, Apodaca

Tel: +52 81 8156 6000

MY – Malaysia, Shah Alam

Tel: +603-78490800

NL – The Netherlands, Oldenzaal

Tel: +31 (0)541 585 000
parker.nl@parker.com

NO – Norway, Stavanger

Tel: +47 (0)51 826 300
parker.norway@parker.com

NZ – New Zealand, Mt Wellington

Tel: +64 9 574 1744

PL – Poland, Warsaw

Tel: +48 (0)22 573 24 00
parker.poland@parker.com

PT – Portugal, Leca da Palmeira

Tel: +351 22 999 7360
parker.portugal@parker.com

RO – Romania, Bucharest

Tel: +40 21 252 1382
parker.romania@parker.com

RU – Russia, Moscow

Tel: +7 495 645-2156
parker.russia@parker.com

SE – Sweden, Sp nga

Tel: +46 (0)8 59 79 50 00
parker.sweden@parker.com

SG – Singapore,

Tel: +65 6887 6300

SK – Slovakia, Bansk Bystrica

Tel: +421 484 162 252
parker.slovakia@parker.com

SL – Slovenia, Novo Mesto

Tel: +386 7 337 6650
parker.slovenia@parker.com

TH – Thailand, Bangkok

Tel: +662 717 8140

TR – Turkey, Istanbul

Tel: +90 216 4997081
parker.turkey@parker.com

TW – Taiwan, Taipei

Tel: +886 2 2298 8987

UA – Ukraine, Kiev

Tel: +380 44 494 2731
parker.ukraine@parker.com

UK – United Kingdom, Barnstaple

Tel: +44 (0)1271 313131
parker.uk@parker.com

US – USA, Cleveland

Tel: +1 216 896 3000

VE – Venezuela, Caracas

Tel: +58 212 238 5422

ZA – South Africa, Kempton Park

Tel: +27 (0)11 961 0700
parker.southafrica@parker.com

European Product Information Centre

Free phone: 00 800 27 27 5374

(from AT, BE, CH, CZ, DE, DK, EE, EI, ES, FI, FR, IT, NL, NO, PL, RU, SE, SK, UK, ZA)

© 2008 Parker Hannifin Corporation. All rights reserved



Parker Hannifin Ltd
**Instrumentation Products
Division Europe,**
Riverside Road,
Pottington Business Park,
Barnstaple, Devon, EX31 1NP
United Kingdom
Tel.: +44 (0) 1271 313131
Fax: +44 (0) 1271 373636
www.parker.com/ipd

Parker Hannifin Corporation
Instrumentation Products Division
1005 A Cleaner Way
Huntsville, AL 35805
Tel: + 1 (256) 881-2040
Fax: + 1 (256) 881-5072
www.parker.com/ipdus

Catalogue 4190-PM