



EO[®] Ermeto Original ***Rotary fittings***



Visual index EO rotary fittings

DG 101
p. Q6

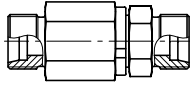

EO 24° cone end /
EO 24° cone end

DG 102-R
p. Q7

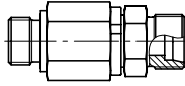

Male BSPP thread –
ED-seal (ISO 1179) / EO 24° cone end

DG 102-M
p. Q8

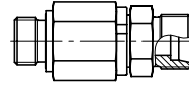

Male metric thread –
ED-seal (ISO 1179) / EO 24° cone end

DG 103
p. Q9

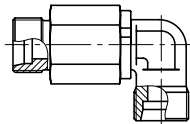

EO 24° cone end /
EO 24° cone end

DG 104-R
p. Q10

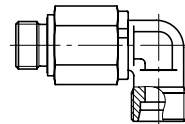

Male BSPP thread –
ED-seal (ISO 1179) / EO 24° cone end

DG 104-M
p. Q11

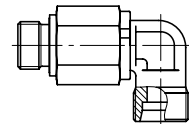

Male metric thread –
ED-seal (ISO 1179) / EO 24° cone end

DG 105
p. Q12

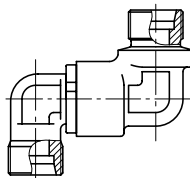

EO 24° cone end /
EO 24° cone end

DG 106-R
p. Q13

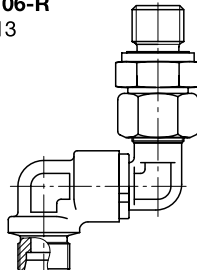

Male BSPP thread –
ED-seal (ISO 1179) / EO 24° cone end

DG 106-M
p. Q14

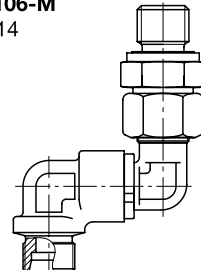

Male metric thread –
ED-seal (ISO 1179) / EO 24° cone end

DG 107
p. Q15

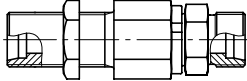

EO 24° cone end /
EO 24° cone end

DG 108
p. Q16

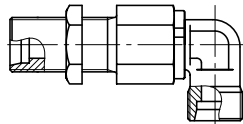

EO 24° cone end /
EO 24° cone end

DG 208
p. Q17

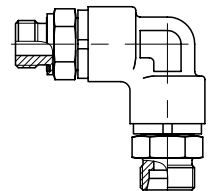

Male BSPP thread –
ED-seal (ISO 1179) / EO 24° cone end

DVGE-R
p. Q18

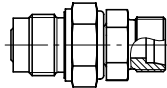

Male BSPP thread –
ED-seal / EO 24° cone end

DVGE-M
p. Q19

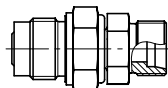

Male metric thread –
ED-seal / EO 24° cone end

DVWE-R
p. Q20

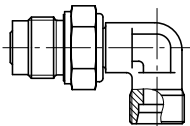

Male BSPP thread –
ED-seal / EO 24° cone end

DVWE-M
p. Q21

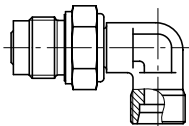

Male metric thread –
ED-seal / EO 24° cone end

DG Ball bearing rotary fittings

For working pressures up to 350 bar.
Favourable pressure/RPM ratio

Application:

Connecting a fixed point to a rotating, swinging or moving machine part via hoses.
To prevent torsion and to avoid small hose radius.

Flow media:

Hydraulic oils and lubricants on mineral oil base.
Also for hydraulic fluids HETG and HEES.
Not suitable for corrosive and HFC-fluids or gases.

Construction:

Compact, maintenance-free construction, service-proved. Combined ball and plain bearing with constant lubrication. Low starting torque. Wear-resistant annular piston sealings.

Materials:

Casing, body nut of steel, annular piston sealing: POM (e. g. Delrin)/FKM. Eolastic sealing: NBR (e.g. Perbunan), also available in FKM.

Surface:

Cr(VI)-free.

Nominal temperatures:

-14° C up to +80°C.

Warehousing:

Ball bearing rotary fittings can be stocked for 6 months. Warehousing up to 1 year is possible with storage conditions acc. to DIN 7716.

Perbunan = registered trademark of Bayer

Construction systems:

8 different versions with one rotational axis. Multiaxial rotary couplings on request. Tube connections according to DIN 2353, series S.
Maximum working pressure 350 bar (peak pressure)
Male stud sealing by Eolastic seals of NBR.
Male stud with metric parallel or BSPP thread.

Assembly instructions:

The life of a rotary fitting depends considerably on a stress-free line connection. Therefore the direct connection with tubes is to be avoided.
For connection of hoses the use of swivel nut fittings (DIN 3865) is recommended.
We recommend short, straight hose lines (free hose length approx. 5× hose O.D.). Thus shocks, vibrations etc. are absorbed.

Attention!

Maximum permissible flowrate of media: 5 m/s (see page C13.)

Number of revolutions and starting torques:

Chart 1

Tube O.D.	DN Nominal diameter (mm)	Permissible number of revolutions (rpm.) under a working pressure of						Initial torque at 250 bar/Nm
		25 bar	64 bar	100 bar	160 bar	250 bar	350 bar	
6 8	5.0	1500	750	400	200	85	85	0.08
12 16	9.5	800	400	200	100	45	45	0.24
20 25	16.0	300	150	75	38	15	15	0.8
30 38	26.0	200	100	50	25	10	10	2.0

DG Ball bearing rotary fittings

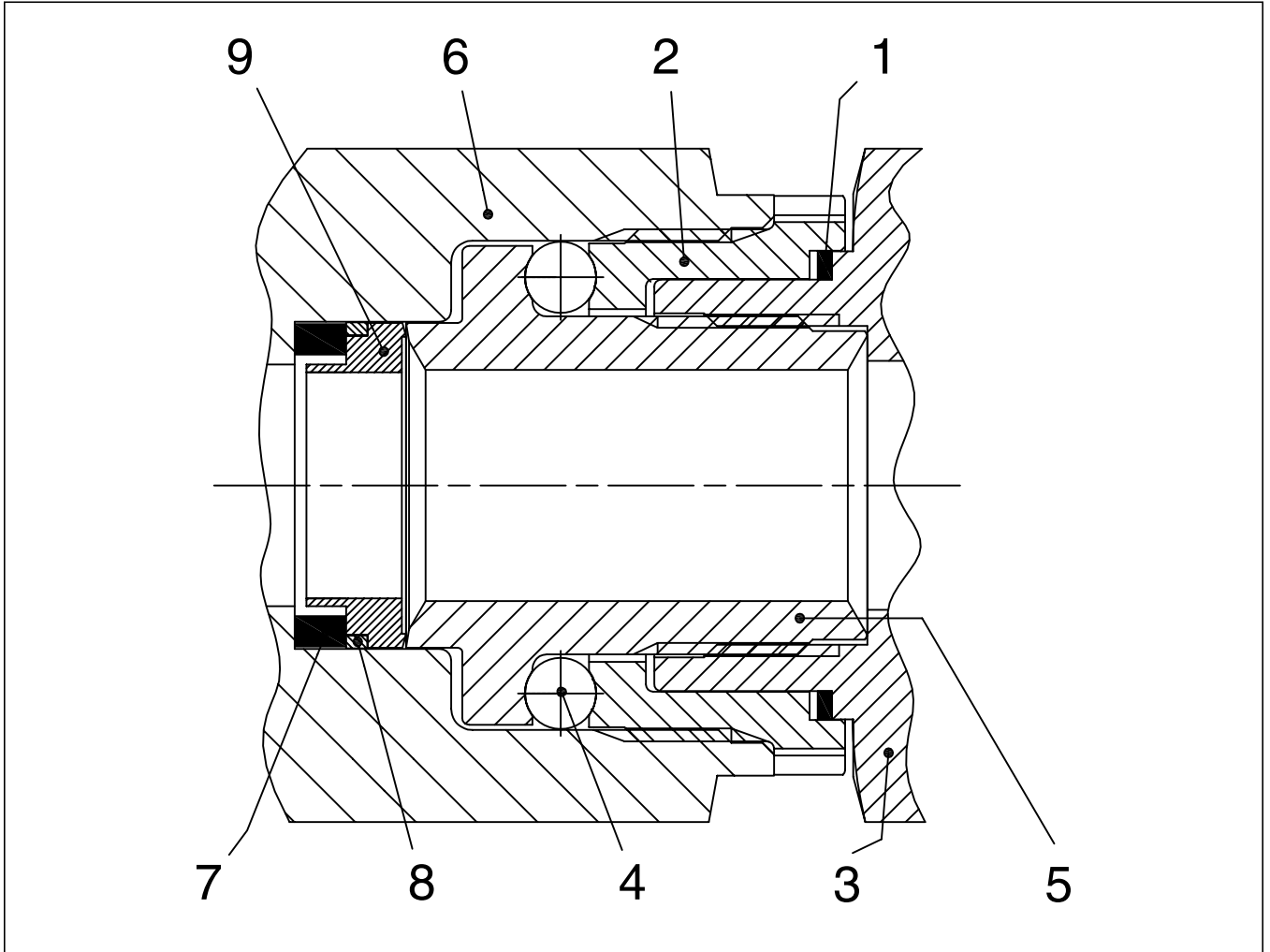

9	ring piston
8	intermediate ring
7	rubber spring
6	base
5	pivot
4	ball
3	top
2	raceway
1	dust seal
position	specification

Plain bearing rotary fittings

for slow rotating, swinging or moving machine parts up to 40 bar (series L) or up to 100 bar (series S).

Application:

Connecting a fixed point to a rotating, swinging or moving machine part via hoses.
To prevent torsion and to avoid small hose radius.

Flow media:

Hydraulic oils and lubricants on mineral oil base.
Also for hydraulic fluids HETG and HEES.
Not suitable for corrosive and HFC-fluids or gases.

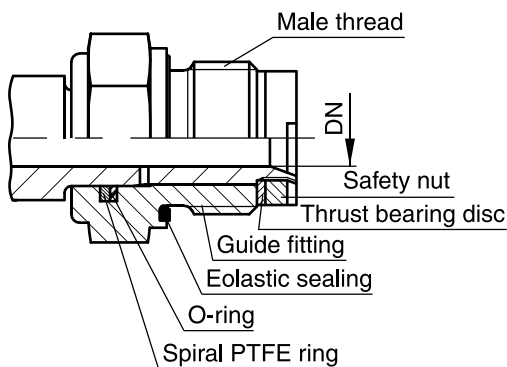

Nominal temperature:

For sealings of NBR:
–35° C up to +100° C.
For sealings of FKM:
–25° C up to +120° C.

Tube O.D.		DN Nominal diameter mm
06L	06S	4
08L	08S	5
10L	10S	6
12L	12S	8
15L	14S 16S	10
18L 22L	20S 25S	16
28L	30S	22
35L	43L 38S	25

Construction:

Compact, maintenance-free construction, service-proved.

Materials:

Casing, body nut and progressive ring of steel. Sealing of NBR (Perbunan), on request of FKM.
Plain bearing rotary fittings are not available in stainless steel or brass.

Surface:

Cr(VI)-free.

Construction-system:

Series L, tube O. D. 6 to 35 mm, working pressure (PN): 40 bar
Series S, tube O. D. 6 to 38 mm, working pressure (PN): 100 bar
Tube connection according to DIN 2353, ISO 8434-1.
Male stud with metric thread and BSP thread.
Sealing of male stud by Eolastic-seals.

Perbunan = registered trademark of Bayer

Number of revolutions:

Series	L								
Tube O.D.	6	8	10	12	15	18	22	28	35
Permiss. no. rpm	28	28	21	17	13	10	10	7	7
Series	S								
Tube O.D.	6	8	10	12	14	16	20	25	30 38
Permiss. no rpm	11	11	9	7	5	5	4	4	3 3

Assembly instruction:

The life of a rotary fitting depends considerably on a stress-free line connection. Therefore the direct connection with tubes is to be avoided.

For connection of hoses use of swivel nut connections (DIN 3865) is recommended.

We recommend short, straight hose lines (free hose length approx. 5x hose O. D.). Thus shocks, vibrations etc. are absorbed.

DG 101 Straight ball bearing rotary union

EO 24° cone end / EO 24° cone end

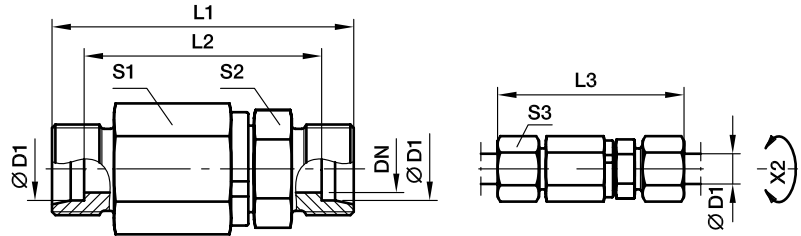

X2) Axis

Series	D1 	DN	L1	L2	L3	S1	S2	S3	Weight g/1 piece	Order code*	CF ¹⁾
S ⁴⁾	06	5.0	61	47	76	22.0	17	17.0	113	DG101/06SOMD	Pressure ratings see chart 1
	08	5.0	61	47	76	22.0	17	19.0	118	DG101/08SOMD	
	12	9.5	72	57	89	30.0	24	24.0	258	DG101/12SOMD	
	16	9.5	74	57	93	30.0	27	30.0	264	DG101/16SOMD	
	20	16.0	92	71	114	41.0	36	36.0	578	DG101/20SOMD	
	25	16.0	96	72	120	41.0	41	46.0	652	DG101/25SOMD	Pressure ratings see chart 1
	30	26.0	109	82	135	60.0	46	50.0	1321	DG101/30SOMD	
	38	26.0	114	82	143	60.0	55	60.0	1509	DG101/38SOMD	

¹⁾ Pressure shown = item deliverable

⁴⁾ S = heavy series

$\frac{PN \text{ (bar)}}{10} = PN \text{ (MPa)}$

Delivery without nut and ring. Information on ordering complete fittings or alternative sealing materials see page 17.

*Please add the **suffixes** below according to the material/surface required.

Order code suffixes			
Material	Suffix surface and material	Example	Standard sealing material (no additional suffix needed)
Steel, zinc plated, Cr(VI)-free	CF	DG101/06SOMDCF	VIT

DG 102-R Straight male stud ball bearing rotary union

Male BSPP thread – ED-seal (ISO 1179) / EO 24° cone end

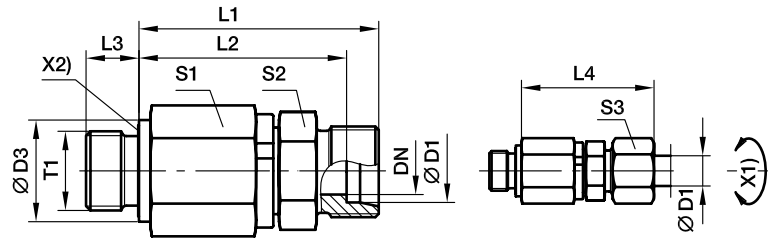

X1) Axis
X2) Eolastic-sealing

Series	D1	T1	DN	D3	L1	L2	L3	L4	S1	S2	S3	Weight g/1 piece	Order code*	CF ¹⁾
S ⁴⁾	06	G 1/4 A	5.0	19	49	42.0	12	57.0	22	17	17	110	DG102/06SROMD	Pressure ratings see chart 1
	08	G 1/4 A	5.0	19	49	42.0	12	57.0	22	17	19	116	DG102/08SROMD	
	12	G 3/8 A	9.5	22	60	52.5	12	69.0	30	24	24	243	DG102/12SROMD	
	16	G 1/2 A	9.5	27	60	51.5	14	70.0	30	27	30	256	DG102/16SROMD	
	20	G 3/4 A	16.0	32	76	65.5	16	87.5	41	36	36	558	DG102/20SROMD	
	25	G 1 A	16.0	40	78	66.0	18	90.5	41	41	46	853	DG102/25SROMD	Pressure ratings see chart 1
	30	G 1 1/4 A	26.0	50	89	75.5	20	102.0	60	46	50	1312	DG102/30SROMD	
	38	G 1 1/2 A	26.0	55	92	76.0	22	107.0	60	55	60	1494	DG102/38SROMD	

¹⁾ Pressure shown = item deliverable

⁴⁾ S = heavy series

$\frac{PN \text{ (bar)}}{10} = PN \text{ (MPa)}$

Delivery without nut and ring. Information on ordering complete fittings or alternative sealing materials see page 17.

*Please add the **suffixes** below according to the material/surface required.

Order code suffixes			
Material	Suffix surface and material	Example	Standard sealing material (no additional suffix needed)
Steel, zinc plated, Cr(VI)-free	CF	DG102/06SROMDCF	VIT/NBR

DG 102-M Straight male stud ball bearing rotary union

Male metric thread – ED-seal (ISO 9974) / EO 24° cone end

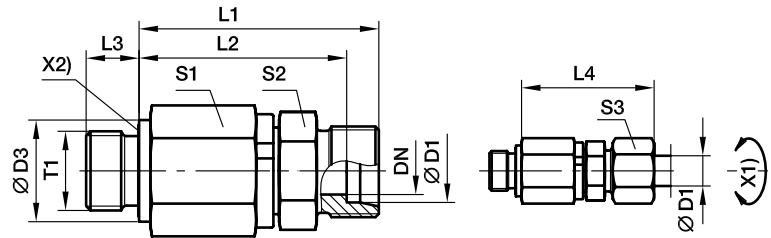

X1) Axis
X2) Eolastic-sealing

Series	D1	T1	DN	D3	L1	L2	L3	L4	S1	S2	S3	Weight g/1 piece	Order code*	CF ¹⁾
S ⁴⁾	06	M 14×1.5	5.0	19	49	42.0	12	57.0	22	17	17	112	DG102/06SMOMD	Pressure ratings see chart 1
	08	M 14×1.5	5.0	19	49	42.0	12	57.0	22	17	19	113	DG102/08SMOMD	
	12	M 18×1.5	9.5	24	60	52.5	12	69.0	30	24	24	245	DG102/12SMOMD	
	16	M 22×1.5	9.5	27	60	51.5	14	70.0	30	27	30	259	DG102/16SMOMD	
	20	M 27×2.0	16.0	32	76	65.5	16	87.5	41	36	36	558	DG102/20SMOMD	
	25	M 33×2.0	16.0	40	78	66.0	18	90.5	41	41	46	637	DG102/25SMOMD	Pressure ratings see chart 1
	30	M 42×2.0	26.0	50	89	75.5	20	102.0	60	46	50	1316	DG102/30SMOMD	
	38	M 48×2.0	26.0	55	92	76.0	22	107.0	60	55	60	1491	DG102/38SMOMD	

¹⁾Pressure shown = item deliverable

⁴⁾S = heavy series

$\frac{PN \text{ (bar)}}{10} = PN \text{ (MPa)}$

Delivery without nut and ring. Information on ordering complete fittings or alternative sealing materials see page 17.

*Please add the **suffixes** below according to the material/surface required.

Order code suffixes			
Material	Suffix surface and material	Example	Standard sealing material (no additional suffix needed)
Steel, zinc plated, Cr(VI)-free	CF	DG102/06SMOMDCF	VIT/NBR

DG 103 Elbow ball bearing rotary union

EO 24° cone end / EO 24° cone end

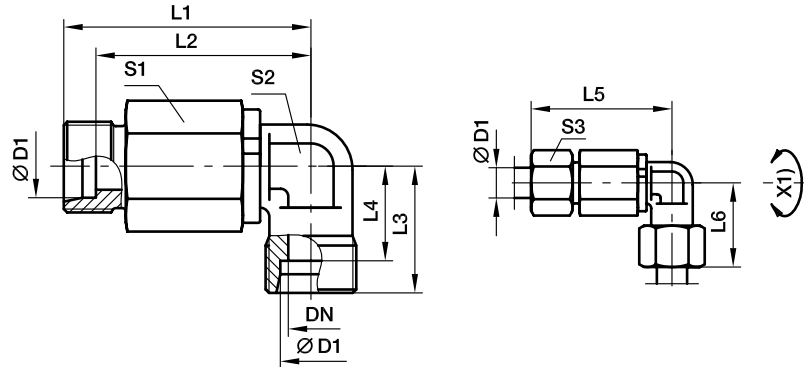

X2) Axis

Series	D1	DN	L1	L2	L3	L4	L5	L6	S1	S2	S3	Weight g/1 piece	Order code*	CF ¹⁾
S ⁴⁾	06	5.0	51.5	59.0	23	16.0	44.5	16.0	22	17	17	134	DG103/06SOMD	Pressure ratings see chart 1
	08	5.0	51.5	59.0	24	17.0	44.5	17.0	22	17	19	141	DG103/08SOMD	
	12	9.5	63.0	72.0	29	21.5	55.5	21.5	30	22	24	296	DG103/12SOMD	
	16	9.5	63.0	73.0	33	24.5	54.5	24.5	30	22	30	298	DG103/16SOMD	
	20	16.0	83.0	94.5	37	26.5	72.5	26.5	41	36	36	772	DG103/20SOMD	
	25	16.0	83.0	95.5	42	30.0	71.0	30.0	41	36	46	803	DG103/25SOMD	Pressure ratings see chart 1
	30	26.0	102.5	116.0	49	35.5	89.0	35.5	60	50	50	1722	DG103/30SOMD	
	38	26.0	102.5	117.0	57	41.0	86.5	41.0	60	50	60	1931	DG103/38SOMD	

¹⁾ Pressure shown = item deliverable

⁴⁾ S = heavy series

$\frac{PN \text{ (bar)}}{10} = PN \text{ (MPa)}$

Delivery without nut and ring. Information on ordering complete fittings or alternative sealing materials see page 17.

*Please add the **suffixes** below according to the material/surface required.

Order code suffixes			
Material	Suffix surface and material	Example	Standard sealing material (no additional suffix needed)
Steel, zinc plated, Cr(VI)-free	CF	DG103/06SOMDCF	VIT

DG 104-R Elbow male stud ball bearing rotary union

Male BSPP thread – ED-seal (ISO 1179) / EO 24° cone end

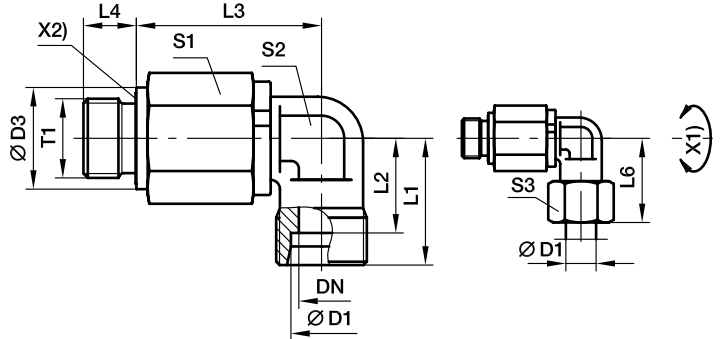

X1) Axis
X2) Eolastic-sealing

Series	D1	T1	DN	D3	L1	L2	L3	L4	L6	S1	S2	S3	Weight g/1 piece	Order code*	CF ¹⁾
S ⁴⁾	06	G 1/4 A	05	19	23	16.0	39.5	12	31	22	17	17	131	DG104/06SROMD	Pressure ratings see chart 1
	08	G 1/4 A	05	19	24	17.0	39.5	12	32	22	17	19	135	DG104/08SROMD	
	12	G 3/8 A	10	22	29	21.5	51.0	12	38	30	22	24	284	DG104/12SROMD	
	16	G 1/2 A	10	27	33	24.5	49.0	14	43	30	22	30	284	DG104/16SROMD	
	20	G 3/4 A	16	32	37	26.5	67.0	16	48	41	36	36	752	DG104/20SROMD	
25	G 1 A	16	40	42	30.0	65.0	18	54	41	36	46	789	DG104/25SROMD	Pressure ratings see chart 1	
30	G 1 1/4 A	26	50	49	35.5	82.5	20	62	60	50	50	1713	DG104/30SROMD		
38	G 1 1/2 A	26	55	57	41.0	80.5	22	72	60	50	60	1915	DG104/38SROMD		

¹⁾Pressure shown = item deliverable

⁴⁾S = heavy series

$\frac{PN \text{ (bar)}}{10} = PN \text{ (MPa)}$

Delivery without nut and ring. Information on ordering complete fittings or alternative sealing materials see page 17.

*Please add the **suffixes** below according to the material/ surface required.

Order code suffixes			
Material	Suffix surface and material	Example	Standard sealing material (no additional suffix needed)
Steel, zinc plated, Cr(VI)-free	CF	DG104/06SROMDCF	VIT/NBR

DG 104-M Elbow male stud ball bearing rotary union

Male metric thread – ED-seal (ISO 9974) / EO 24° cone end

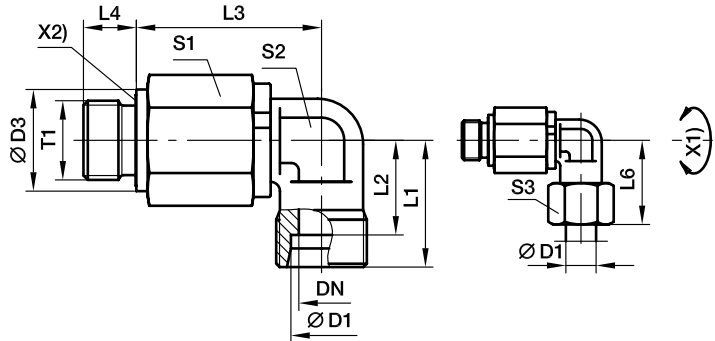

X1) Axis
X2) Eolastic-sealing

Series	D1	T1	DN	D3	L1	L2	L3	L4	L6	S1	S2	S3	Weight g/1 piece	Order code*	CF ¹⁾
S ⁴⁾	06	M 14×1.5	05	19	23	16.0	39.5	12	31	22	17	17	132	DG104/06SMOMD	Pressure ratings see chart 1
	08	M 14×1.5	05	19	24	17.0	39.5	12	32	22	17	19	136	DG104/08SMOMD	
	12	M 18×1.5	10	22	29	21.5	51.0	12	38	30	22	24	286	DG104/12SMOMD	
	16	M 22×1.5	10	27	33	24.5	49.0	14	43	30	22	30	287	DG104/16SMOMD	
	20	M 27×2.0	16	32	37	26.5	67.0	16	48	41	36	36	752	DG104/20SMOMD	
	25	M 33×2.0	16	40	42	30.0	65.0	18	54	41	36	46	788	DG104/25SMOMD	Pressure ratings see chart 1
	30	M 42×2.0	26	50	49	35.5	82.5	20	62	60	50	50	1717	DG104/30SMOMD	
	38	M 48×2.0	26	55	57	41.0	80.5	22	72	60	50	60	1913	DG104/38SMOMD	

¹⁾ Pressure shown = item deliverable

⁴⁾ S = heavy series

$\frac{PN \text{ (bar)}}{10} = PN \text{ (MPa)}$

Delivery without nut and ring. Information on ordering complete fittings or alternative sealing materials see page 17.

*Please add the suffixes below according to the material/surface required.

Order code suffixes			
Material	Suffix surface and material	Example	Standard sealing material (no additional suffix needed)
Steel, zinc plated, Cr(VI)-free	CF	DG104/06SMOMDCF	VIT/NBR

DG 105 Double elbow ball bearing rotary union

EO 24° cone end / EO 24° cone end

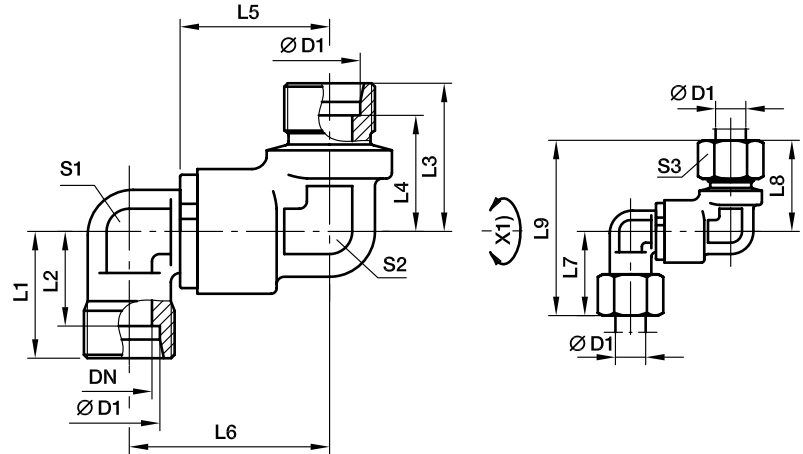

X1) Axis

Series	D1	DN	L1	L2	L3	L4	L5	L6	L7	L8	L9	S1	S2	S3	Weight g/1 piece	Order code*	CF ¹⁾
S ⁴⁾	12	9.5	39.5	26.5	43	21.5	38	81	53.0	24	22	24	29	50.5	384	DG105/12SOMD	Pressure ratings see chart 1
	16	9.5	39.5	25.5	44	24.5	43	87	53.0	30	22	24	33	52.5	377	DG105/16SOMD	
	20	16.0	56.5	39.5	61	26.5	48	109	76.0	36	36	32	37	71.5	1015	DG105/20SOMD	
	25	16.0	56.5	38.0	62	30.0	54	116	76.0	46	36	32	42	74.0	1034	DG105/25SOMD	
	30	26.0	65.0	44.5	71	35.5	62	133	92.5	50	50	50	49	84.5	2344	DG105/30SOMD	
	38	26.0	65.0	42.0	73	41.0	72	145	92.5	60	50	50	57	89.0	2485	DG105/38SOMD	

¹⁾Pressure shown = item deliverable

⁴⁾S = heavy series

$\frac{PN \text{ (bar)}}{10} = PN \text{ (MPa)}$

Delivery without nut and ring. Information on ordering complete fittings or alternative sealing materials see page I7.

*Please add the **suffixes** below according to the material/surface required.

Order code suffixes			
Material	Suffix surface and material	Example	Standard sealing material (no additional suffix needed)
Steel, zinc plated, Cr(VI)-free	CF	DG105/12SOMDCF	VIT

DG 106-R Double elbow male stud ball bearing rotary union

Male BSPP thread – ED-seal (ISO 1179) / EO 24° cone end
 (Adjustable at male thread axis, consisting of DG105 + EGE)

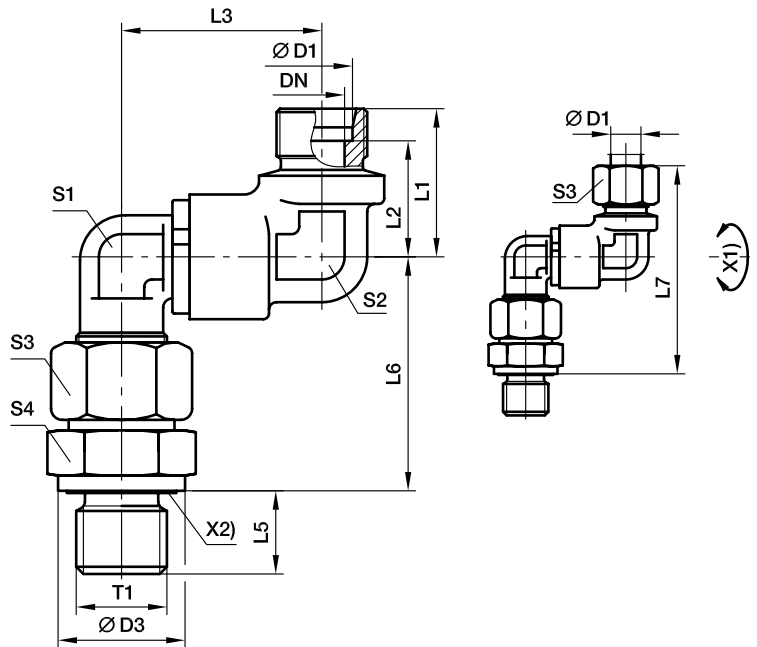

X1) Axis
 X2) Eolastic-sealing

Series	D1	T1	DN	D3	L1	L2	L3	L5	L6	L7	S1	S2	S3	S4	Weight g/1 piece	Order code*	CF ¹⁾
S ⁴⁾	12	G 3/8 A	9.5	24	34	26.5	53.0	12	55.5	99	24	22	24	22	484	DG106/12SROMD	Pressure ratings see chart 1
	16	G 1/2 A	9.5	27	34	25.5	53.0	14	61.5	105	24	24	30	27	547	DG106/16SROMD	
	20	G 3/4 A	16.0	32	50	39.5	76.0	16	69.5	131	36	32	36	32	1288	DG106/20SROMD	
	25	G 1 A	16.0	40	50	38.0	76.0	18	78.0	140	36	32	46	41	1528	DG106/25SROMD	
	30	G 1 1/4 A	26.0	50	58	44.5	92.5	20	86.5	158	50	50	50	50	3004	DG106/30SROMD	
	38	G 1 1/2 A	26.0	55	58	42.0	92.5	22	101.0	174	50	50	60	55	3419	DG106/38SROMD	

¹⁾Pressure shown = item deliverable

⁴⁾S = heavy series

$\frac{PN \text{ (bar)}}{10} = PN \text{ (MPa)}$

Delivery without nut and ring. Information on ordering complete fittings or alternative sealing materials see page 17.

*Please add the suffixes below according to the material/surface required.

Order code suffixes			
Material	Suffix surface and material	Example	Standard sealing material (no additional suffix needed)
Steel, zinc plated, Cr(VI)-free	CF	DG106/06SROMDCF	VIT/NBR

DG 106-M Double elbow male stud ball bearing rotary union

Male metric thread – ED-seal (ISO 9974) / EO 24° cone end
(Adjustable at male thread axis, consisting of DG105 + EGE)

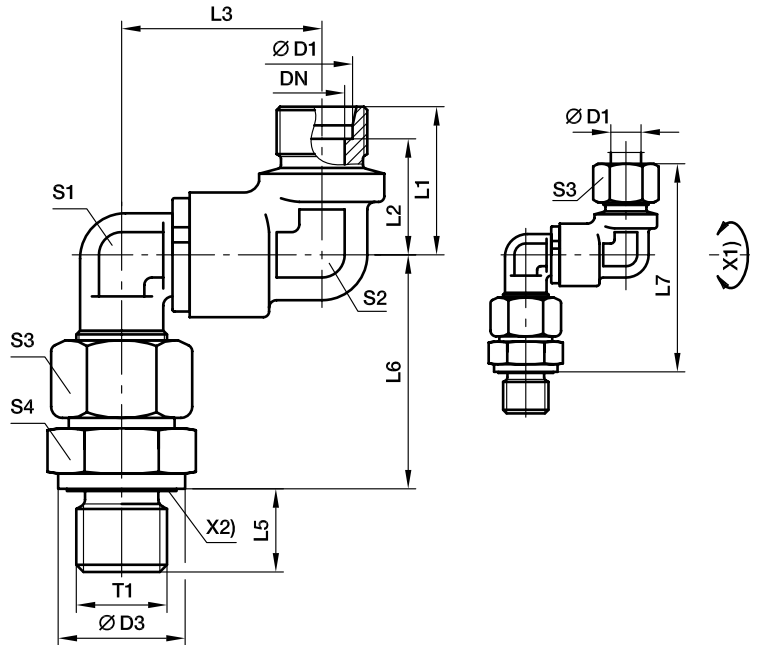

X1) Axis
X2) Eolastic-sealing

Series	D1	T1	DN	D3	L1	L2	L3	L5	L6	L7	S1	S2	S3	S4	Weight g/1 piece	Order code*	CF ¹⁾
S ⁴⁾	12	M 18×1.5	5.0	24	34	26.5	53.0	12	55.5	99	24	22	24	24	495	DG106/12SMOMD	Pressure ratings see chart 1
	16	M 22×1.5	9.5	27	34	25.5	53.0	14	61.5	105	24	24	30	27	551	DG106/16SMOMD	
	20	M 27×2.0	16.0	32	50	39.5	76.0	16	69.5	131	36	32	36	32	1289	DG106/20SMOMD	
	25	M 33×2.0	16.0	40	50	38.0	76.0	18	78.0	140	36	32	46	41	1532	DG106/25SMOMD	
	30	M 42×2.0	26.0	50	58	44.5	92.5	20	86.5	158	50	50	50	50	3007	DG106/30SMOMD	
	38	M 48×2.0	26.0	55	58	42.0	92.5	22	101.0	174	50	50	60	55	3441	DG106/38SMOMD	

¹⁾Pressure shown = item deliverable

⁴⁾S = heavy series

$\frac{PN \text{ (bar)}}{10} = PN \text{ (MPa)}$

Delivery without nut and ring. Information on ordering complete fittings or alternative sealing materials see page 17.

*Please add the **suffixes** below according to the material/ surface required.

Order code suffixes			
Material	Suffix surface and material	Example	Standard sealing material (no additional. suffix needed)
Steel, zinc plated, Cr(VI)-free	CF	DG106/06SMOMDCF	VIT/NBR

DG 107 Straight bulkhead ball bearing rotary union

EO 24° cone end / EO 24° cone end

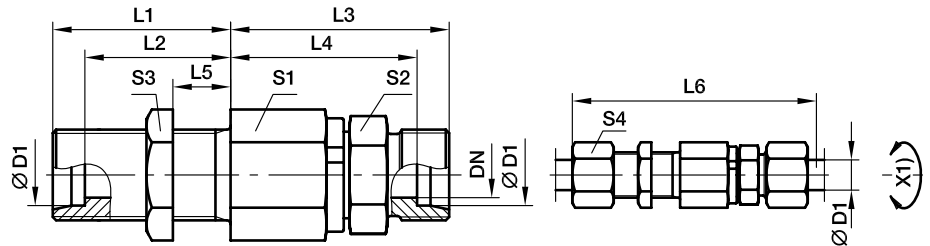

X1) Axis

Series	D1	DN	T1	L1	L2	L3	L4	L5	L6	S1	S2	S3	S4	Weight g/1 piece	Order code*	CF ¹⁾
S ⁴⁾	06	5.0	M 14×1.5	23	16.0	49	42.0	5	87	22	17	19	17	134	DG107/06SOMD	Pressure ratings see chart 1
	08	5.0	M 16×1.5	23	16.0	49	42.0	5	87	22	17	22	19	143	DG107/08SOMD	
	12	9.5	M 20×1.5	23	15.5	60	52.5	5	100	30	24	27	24	291	DG107/12SOMD	
	16	9.5	M 24×1.5	26	17.5	60	51.5	5	105	30	27	32	30	328	DG107/16SOMD	
	20	16.0	M 30×2.0	39	28.5	76	65.5	15	137	41	36	41	36	710	DG107/20SOMD	Pressure ratings see chart 1
	25	16.0	M 36×2.0	42	30.0	78	66.0	15	144	41	41	46	46	847	DG107/25SOMD	
	30	26.0	M 42×2.0	44	30.5	89	75.5	15	159	60	46	50	50	1533	DG107/30SOMD	
	38	26.0	M 52×2.0	47	31.0	92	76.0	15	168	60	55	65	60	1930	DG107/38SOMD	

¹⁾Pressure shown = item deliverable

⁴⁾S = heavy series

$$\frac{PN \text{ (bar)}}{10} = PN \text{ (MPa)}$$

Delivery without nut and ring. Information on ordering complete fittings or alternative sealing materials see page 17.

*Please add the **suffixes** below according to the material/surface required.

Order code suffixes			
Material	Suffix surface and material	Example	Standard sealing material (no additional suffix needed)
Steel, zinc plated, Cr(VI)-free	CF	DG107/06SOMDCF	VIT

DG 108 Elbow bulkhead ball bearing rotary union

EO 24° cone end / EO 24° cone end

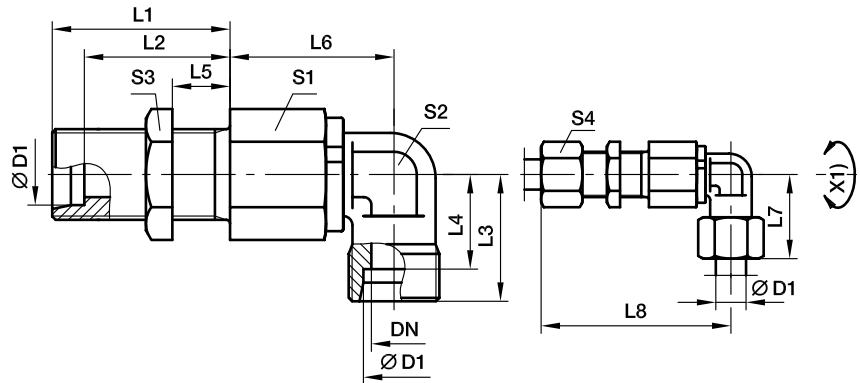

X1) Axis

Series	D1	DN	T1	L1	L2	L3	L4	L5	L6	L7	L8	S1	S2	S3	S4	Weight g/1 piece	Order code*	CF ¹⁾
S ⁴⁾	06	5.0	M 14×1.5	23	16.0	23	16.0	5	39.5	31	70.0	22	17	19	17	154	DG108/06SOMD	Pressure ratings see chart 1
	08	5.0	M 16×1.5	23	16.0	23	17.0	5	39.5	32	70.0	22	17	22	19	166	DG108/08SOMD	
	12	9.5	M 20×1.5	23	15.5	29	21.5	5	51.0	38	83.0	30	22	27	24	333	DG108/12SOMD	
	16	9.5	M 24×1.5	26	17.5	33	24.5	5	49.0	43	85.0	30	22	32	30	354	DG108/16SOMD	
	20	16.0	M 30×2.0	39	28.5	37	26.5	15	67.0	48	117.5	41	36	41	36	904	DG108/20SOMD	
	25	16.0	M 36×2.0	42	30.0	42	30.0	15	65.0	54	119.5	41	36	46	46	999	DG108/25SOMD	Pressure ratings see chart 1
	30	26.0	M 42×2.0	44	30.5	49	35.5	15	82.5	62	140.0	60	50	50	50	1935	DG108/30SOMD	
	38	26.0	M 52×2.0	47	31.0	57	41.0	15	80.5	72	142.0	60	50	65	60	2351	DG108/38SOMD	

¹⁾ Pressure shown = item deliverable

⁴⁾ S = heavy series

$\frac{PN \text{ (bar)}}{10} = PN \text{ (MPa)}$

Delivery without nut and ring. Information on ordering complete fittings or alternative sealing materials see page 17.

*Please add the **suffixes** below according to the material/surface required.

Order code suffixes			
Material	Suffix surface and material	Example	Standard sealing material (no additional suffix needed)
Steel, zinc plated, Cr(VI)-free	CF	DG108/06SOMDCF	VIT

DG 208-R Double elbow male stud ball bearing rotary union

Male BSPP thread – ED-seal (ISO 1179) / EO 24° cone end

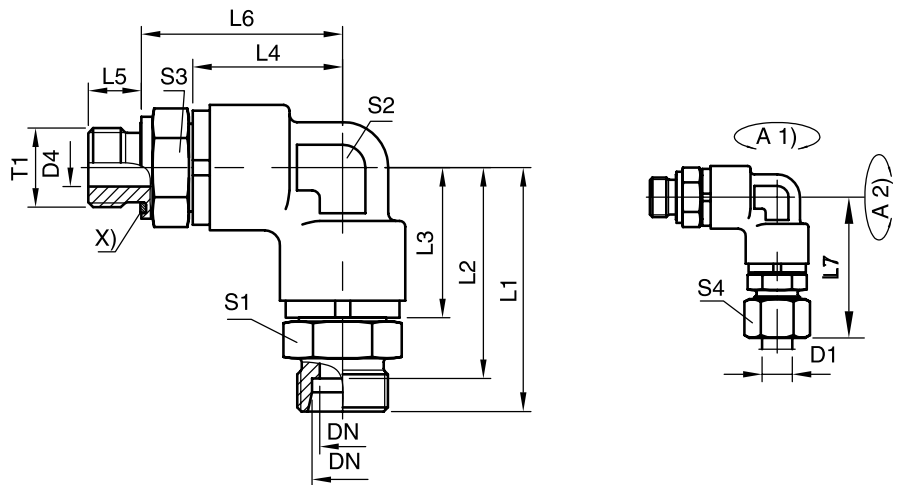

Series	D1	T1	DN	L1	L2	L3	L4	L5	L6	L7	S1	S2	S3	S4	Order code*	CF ¹⁾
S ⁴⁾	12	G 3/8 A	8	61.8	54.3	39.8	39.8	12	52.5	70.3	24	24	24	24	DG208/12SROMD	Pressure ratings see chart 1
	16	G 1/2 A	12	64.5	56.5	39.8	39.8	14	53.0	73.5	27	24	27	30	DG208/16SROMD	
	20	G 3/4 A	16	84.5	74.5	56.5	56.5	16	71.5	95.5	36	32	36	36	DG208/20SROMD	
	25	G 1 A	16	89.5	77.5	56.5	56.5	18	74.5	100.5	41	32	41	46	DG208/25SROMD	
	38	G 1 1/2 A	32	104.0	88.0	65.3	65.3	22	85.3	121.5	55	50	55	60	DG208/38SROMD	

¹⁾ Pressure shown = item deliverable

⁴⁾ S = heavy series

$\frac{PN \text{ (bar)}}{10} = PN \text{ (MPa)}$

Delivery without nut and ring. Information on ordering complete fittings or alternative sealing materials see page 17.



*Please add the **suffixes** below according to the material/surface required.

Order code suffixes			
Material	Suffix surface and material	Example	Standard sealing material (no additional suffix needed)
Steel, zinc plated, Cr(VI)-free	CF	DG208/12SROMDCF	VIT

DVGE-R Straight male stud plain bearing rotary union

Male BSPP thread – ED-seal / EO 24° cone end

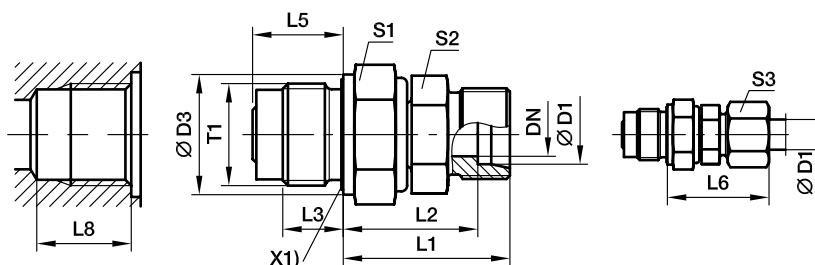

X1) Eolastic-sealing

L8 larger than DIN 3852
chart page Q22

Series	D1	T1	DN	D3	L1	L2	L3	L5	L6	S1	S2	S3	Weight g/1 piece	Order code*	PN (bar) ¹⁾	
															CF	VIT
L ³⁾	06	G 1/4 A	4.0	19	28.0	21.0	12	18.0	40	19	12	14	43	DVGE06LROMD	40	40
	08	G 1/4 A	5.0	19	28.0	21.0	12	18.0	40	19	14	17	44	DVGE08LROMD	40	40
	10	G 3/8 A	6.0	22	32.0	25.0	12	18.0	40	24	17	19	74	DVGE10LROMD	40	40
	12	G 1/2 A	8.0	27	34.0	27.0	14	21.0	42	27	19	22	116	DVGE12LROMD	40	40
	15	G 3/4 A	10.0	32	39.0	32.0	16	24.0	47	32	24	27	214	DVGE15LROMD	40	40
	18	G 1 A	16.0	40	42.5	35.0	18	27.5	51	41	27	32	337	DVGE18LROMD	40	40
	22	G 1 A	16.0	40	46.5	39.0	18	27.5	55	41	32	36	376	DVGE22LROMD	40	40
	28	G 1 1/4 A	22.0	50	48.0	40.5	20	31.0	57	50	41	41	586	DVGE28LROMD	40	40
	35	G 1 1/2 A	25.0	55	55.0	44.5	22	35.0	66	55	46	50	868	DVGE35LROMD	40	40
S ⁴⁾	06	G 1/4 A	4.0	19	30.0	23.0	12	18.0	38	19	14	17	50	DVGE06SROMD	100	100
	08	G 1/4 A	5.0	19	31.0	24.0	12	18.0	39	19	17	19	55	DVGE08SROMD	100	100
	10	G 3/8 A	6.0	22	34.0	26.5	12	18.0	43	24	19	22	85	DVGE10SROMD	100	100
	12	G 1/2 A	8.0	27	36.0	28.5	14	21.0	45	27	22	24	134	DVGE12SROMD	100	100
	14	G 3/4 A	10.0	32	41.0	33.0	16	24.0	51	32	24	27	220	DVGE14SROMD	100	100
	16	G 3/4 A	10.0	32	42.0	33.5	16	24.0	52	32	27	30	230	DVGE16SROMD	100	100
	20	G 1 A	16.0	40	48.5	38.0	18	27.5	60	41	32	36	385	DVGE20SROMD	100	100
	25	G 1 A	16.0	40	52.5	40.5	18	27.5	65	41	41	46	483	DVGE25SROMD	100	100
	30	G 1 1/4 A	22.0	50	55.0	41.5	20	31.0	68	50	46	50	691	DVGE30SROMD	100	100
	38	G 1 1/2 A	25.0	55	63.0	47.0	22	35.0	78	55	55	60	1080	DVGE38SROMD	100	100

¹⁾ Pressure shown = item deliverable

³⁾ L = light series; ⁴⁾ S = heavy series

$\frac{PN \text{ (bar)}}{10} = PN \text{ (MPa)}$

Delivery without nut and ring. Information on ordering complete fittings or alternative sealing materials see page 17.

*Please add the suffixes below according to the material/surface required.

Order code suffixes			
Material	Suffix surface and material	Example	Standard sealing material (no additional suffix needed)
Steel, zinc plated, Cr(VI)-free	CF	DVGE06LROMDCF	NBR
FKM	VITCF	DVGE06LROMDVITCF	

DVGE-M Straight male stud plain bearing rotary union

Male metric thread – ED-seal / EO 24° cone end

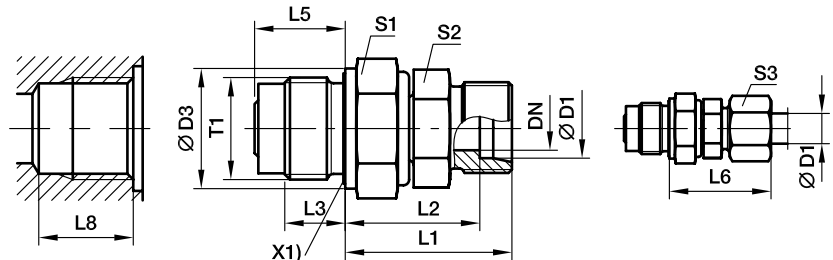

X1) Eolastic-sealing

L8 larger than DIN 3852
chart page Q22

Series	D1 	T1	DN	D3	L1	L2	L3	L5	L6	S1	S2	S3	Weight g/1 piece	Order code*	PN (bar) ¹⁾	
															CF	VIT
L ³⁾	06	M 14×1.5	4.0	19	27.0	20.0	12	18.0	27	19	12	14	44	DVGE06LMOMD	40	40
	08	M 14×1.5	5.0	19	28.0	21.0	12	18.0	29	19	12	17	45	DVGE08LMOMD	40	40
	10	M 18×1.5	6.0	24	33.0	26.0	12	18.0	30	24	14	19	87	DVGE10LMOMD	40	40
	12	M 22×1.5	8.0	27	34.0	27.0	14	21.0	32	27	17	22	120	DVGE12LMOMD	40	40
	15	M 27×2.0	10.0	32	40.0	33.0	16	24.0	36	32	19	27	215	DVGE15LMOMD	40	40
	18	M 33×2.0	16.0	40	45.0	37.5	18	27.5	40	41	27	32	349	DVGE18LMOMD	40	40
	22	M 33×2.0	16.0	40	47.0	39.5	18	27.5	44	41	27	36	383	DVGE22LMOMD	40	40
	28	M 42×2.0	22.0	50	51.5	44.0	20	31.0	47	50	36	41	590	DVGE28LMOMD	40	40
	35	M 48×2.0	25.0	55	64.5	54.0	22	35.0	56	55	41	50	876	DVGE35LMOMD	40	40
	S ⁴⁾	06	M 14×1.5	4.0	19	28.0	21.0	12	18.0	31	19	12	17	51	DVGE06SMOMD	100
08		M 14×1.5	5.0	19	29.0	22.0	12	18.0	32	19	14	19	56	DVGE08SMOMD	100	100
10		M 18×1.5	6.0	24	34.5	27.0	12	18.0	34	24	17	22	98	DVGE10SMOMD	100	100
12		M 22×1.5	8.0	27	35.5	28.0	14	21.0	38	27	17	24	139	DVGE12SMOMD	100	100
16		M 27×2.0	10.0	32	42.5	34.0	16	24.0	43	32	24	30	239	DVGE16SMOMD	100	100
20		M 33×2.0	16.0	40	50.0	39.5	18	27.5	48	41	27	36	385	DVGE20SMOMD	100	100
25		M 33×2.0	16.0	40	54.5	42.5	18	27.5	54	41	36	46	494	DVGE25SMOMD	100	100
30		M 42×2.0	22.0	50	61.5	48.0	20	31.0	62	50	41	50	695	DVGE30SMOMD	100	100
38		M 48×2.0	25.0	55	71.0	55.0	22	35.0	72	55	50	60	1088	DVGE38SMOMD	100	100

¹⁾ Pressure shown = item deliverable

³⁾ L = light series; ⁴⁾ S = heavy series

$\frac{\text{PN (bar)}}{10} = \text{PN (MPa)}$

Delivery without nut and ring. Information on ordering complete fittings or alternative sealing materials see page 17.

*Please add the **suffixes** below according to the material/surface required.

Order code suffixes			
Material	Suffix surface and material	Example	Standard sealing material (no additional suffix needed)
Steel, zinc plated, Cr(VI)-free	CF	DVGE06LMOMDCF	NBR
FKM	VITCF	DVGE06LMOMDVITCF	

DVWE-R Elbow male stud plain bearing rotary union

Male BSPP thread – ED-seal / EO 24° cone end

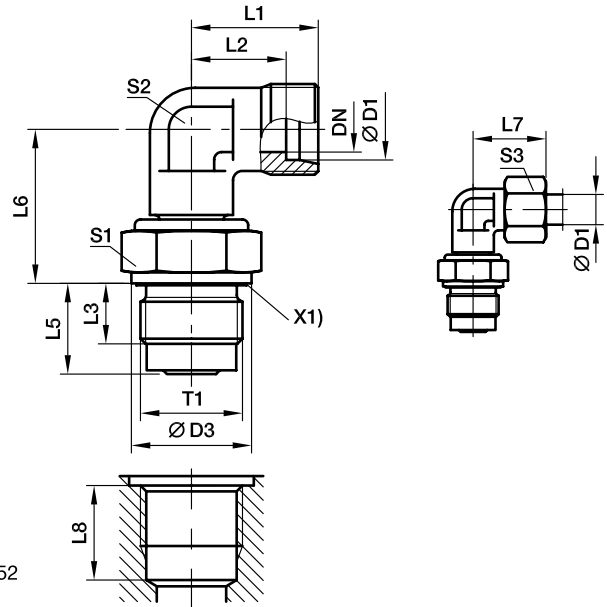

L8 larger than DIN 3852 chart page Q22

X1) Eolastic-sealing

Series	D1	T1	DN	D3	L1	L2	L3	L5	L6	L7	S1	S2	S3	Weight g/1 piece	Order code*	PN (bar) ¹⁾	CF	VIT
L ³⁾	06	G 1/4 A	4	19	19	12.0	12	18.0	20.0	27	19	12	14	50	DVWE06LROMD	40	40	
	08	G 1/4 A	5	19	21	14.0	12	18.0	21.0	29	19	12	17	50	DVWE08LROMD	40	40	
	10	G 3/8 A	6	22	22	15.0	12	18.0	26.0	30	24	14	19	83	DVWE10LROMD	40	40	
	12	G 1/2 A	8	27	24	17.0	14	21.0	27.0	32	27	17	22	129	DVWE12LROMD	40	40	
	15	G 3/4 A	10	32	28	21.0	16	24.0	33.0	36	32	19	27	232	DVWE15LROMD	40	40	
	18	G 1 A	16	40	31	23.5	18	27.5	37.5	40	41	27	32	393	DVWE18LROMD	40	40	
	22	G 1 A	16	40	35	27.5	18	27.5	39.5	44	41	27	36	406	DVWE22LROMD	40	40	
	28	G 1 1/4 A	22	50	38	30.5	20	31.0	44.0	47	50	36	41	664	DVWE28LROMD	40	40	
	35	G 1 1/2 A	25	55	45	34.5	22	35.0	54.0	56	55	41	50	1005	DVWE35LROMD	40	40	
	S ⁴⁾	06	G 1/4 A	4	19	23	16.0	12	18.0	21.0	31	19	12	17	58	DVWE06SROMD	100	100
08		G 1/4 A	5	19	24	17.0	12	18.0	22.0	32	19	14	19	65	DVWE08SROMD	100	100	
10		G 3/8 A	6	22	25	17.5	12	18.0	27.0	34	24	17	22	103	DVWE10SROMD	100	100	
12		G 1/2 A	8	27	29	21.5	14	21.0	28.0	38	27	17	24	152	DVWE12SROMD	100	100	
14		G 3/4 A	10	32	30	22.0	16	24.0	33.0	40	32	19	27	236	DVWE14SROMD	100	100	
16		G 3/4 A	10	32	33	24.5	16	24.0	34.0	43	32	24	30	276	DVWE16SROMD	100	100	
20		G 1 A	16	40	37	26.5	18	27.5	39.5	48	41	27	36	415	DVWE20SROMD	100	100	
25		G 1 A	16	40	42	30.0	18	27.5	42.5	54	41	36	46	569	DVWE25SROMD	100	100	
30		G 1 1/4 A	22	50	49	35.5	20	31.0	48.0	62	50	41	50	886	DVWE30SROMD	100	100	
38		G 1 1/2 A	25	55	57	41.0	22	35.0	55.0	72	55	50	60	1375	DVWE38SROMD	100	100	

¹⁾ Pressure shown = item deliverable

³⁾ L = light series; ⁴⁾ S = heavy series

$$\frac{PN \text{ (bar)}}{10} = PN \text{ (MPa)}$$

Delivery without nut and ring. Information on ordering complete fittings or alternative sealing materials see page I7.

*Please add the suffixes below according to the material/surface required.

Order code suffixes			
Material	Suffix surface and material	Example	Standard sealing material (no additional suffix needed)
Steel, zinc plated, Cr(VI)-free	CF	DVWE06LROMDCF	NBR
FKM	VITCF	DVWE06LROMDVITCF	

DVWE-M Elbow male stud plain bearing rotary union

Male metric thread – ED-seal / EO 24° cone end

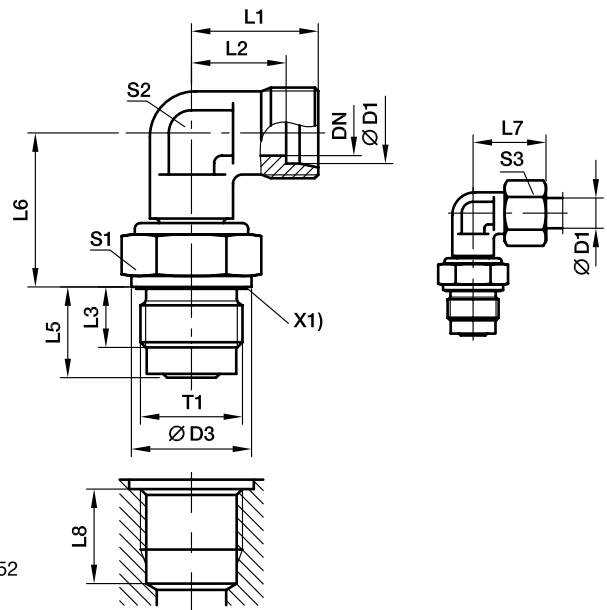

X1) Eolastic-sealing

L8 larger than DIN 3852
chart page Q22

Series	D1	T1	DN	D3	L1	L2	L3	L5	L6	L7	S1	S2	S3	Weight g/1 piece	Order code*	PN (bar) ¹⁾	
																CF	VIT
L ³⁾	06	M 14×1.5	4.0	19	19	12.0	12	18.0	20.0	27	19	12	14	51	DVWE06LMOMD	40	40
	08	M 14×1.5	5.0	19	21	14.0	12	18.0	21.0	29	19	12	17	51	DVWE08LMOMD	40	40
	10	M 18×1.5	6.0	24	22	15.0	12	18.0	26.0	30	24	14	19	92	DVWE10LMOMD	40	40
	12	M 22×1.5	8.0	27	24	17.0	14	21.0	27.0	32	27	17	22	160	DVWE12LMOMD	40	40
	15	M 27×2.0	10.0	32	28	21.0	16	24.0	33.0	36	32	19	27	236	DVWE15LMOMD	40	40
	18	M 33×2.0	16.0	40	31	23.5	18	27.5	37.5	40	41	27	32	405	DVWE18LMOMD	40	40
	22	M 33×2.0	16.0	40	35	27.5	18	27.5	39.5	44	41	27	36	409	DVWE22LMOMD	40	40
	28	M 42×2.0	22.0	50	38	30.5	20	31.0	44.0	47	50	36	41	660	DVWE28LMOMD	40	40
	35	M 48×2.0	25.0	55	45	34.5	22	35.0	54.0	56	55	41	50	1012	DVWE35LMOMD	40	40
	S ⁴⁾	06	M 14×1.5	4.0	19	23	16.0	12	18.0	21.0	31	19	12	17	59	DVWE06SMOMD	100
08		M 14×1.5	5.0	19	24	17.0	12	18.0	22.0	32	19	14	19	66	DVWE08SMOMD	100	100
10		M 18×1.5	6.0	24	25	17.5	12	18.0	27.0	34	24	17	22	113	DVWE10SMOMD	100	100
12		M 22×1.5	8.0	27	29	21.5	14	21.0	28.0	38	27	17	24	153	DVWE12SMOMD	100	100
16		M 27×2.0	10.0	32	33	24.5	16	24.0	34.0	43	32	24	30	284	DVWE16SMOMD	100	100
20		M 33×2.0	16.0	40	37	26.5	18	27.5	39.5	48	41	27	36	427	DVWE20SMOMD	100	100
25		M 33×2.0	16.0	40	42	30.0	18	27.5	42.5	54	41	36	46	581	DVWE25SMOMD	100	100
30		M 42×2.0	22.0	50	49	35.5	20	31.0	48.0	62	50	41	50	898	DVWE30SMOMD	100	100
38		M 48×2.0	25.0	55	57	41.0	22	35.0	55.0	72	55	50	60	1373	DVWE38SMOMD	100	100

¹⁾ Pressure shown = item deliverable

³⁾ L = light series; ⁴⁾ S = heavy series

$\frac{PN \text{ (bar)}}{10} = PN \text{ (MPa)}$

Delivery without nut and ring. Information on ordering complete fittings or alternative sealing materials see page I7.

*Please add the **suffixes** below according to the material/surface required.

Order code suffixes			
Material	Suffix surface and material	Example	Standard sealing material (no additional suffix needed)
Steel, zinc plated, Cr(VI)-free	CF	DVWE06LMOMDCF	NBR
FKM	VITCF	DVWE06LMOMDVITCF	

Port tapping for plain bearing rotary fittings DVGE and DVWE

Port tapping form X
according to DIN 3852, part 1 and part 2
(for parallel male studs)

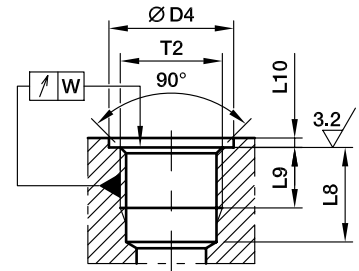

Thread d1	d4 small +0.4	a ₁ max	L9 min	L8 min	W
M 14×1.5	20	1.5	12	19.0	0.1
M 18×1.5	25 ²⁾	2.0	12	19.0	0.1
M 22×1.5	28	2.5	14	22.0	0.1
M 27×2.0	33	2.5	16	25.0	0.2
M 33×2.0	41 ²⁾	2.5	18	28.5	0.2
M 42×2.0	51 ²⁾	2.5	20	32.0	0.2
M 48×2.0	56	2.5	22	36.0	0.2
G 1/4 A	20 ²⁾	1.5	12	19.0	0.1
G 3/8 A	23	2.0	12	19.0	0.1
G 1/2 A	28 ²⁾	2.5	14	22.0	0.1
G 3/4 A	33	2.5	16	25.0	0.2
G 1 A	41 ²⁾	2.5	18	28.5	0.2
G 1 1/4 A	51 ²⁾	2.5	20	32.0	0.2
G 1 1/2 A	56	2.5	22	36.0	0.2

¹⁾ Not in DIN 3852

²⁾ Different from DIN 3852