



aerospace  
climate control  
electromechanical  
filtration  
fluid & gas handling  
hydraulics  
pneumatics  
process control  
sealing & shielding



# Hydraulic Hoses, Fittings and Equipment

High Pressure



ENGINEERING YOUR SUCCESS.

# High Pressure Hoses and Fittings

Three systems for heavy duty performers

## Multispiral Parkrimp *No-Skive*

Crimpable with  
Parkrimp System



## Compact Spiral Interlock *No-Skive*

Crimpable with  
Parkrimp System



## ParLock Interlock Skive

Crimpable with  
adjustable crimpers



## Applications

The definitive hose range for all  
high pressure applications



# Crimper systems you can trust

## Parkrimp crimpers for *No-Skive* one-piece fittings



KarryKrimp® 2



KarryKrimp® 2  
Bench Mount



Parkrimp®

## Adjustable crimpers for two-piece ParLock fittings



TH8E-530



TH 8E-380-BM



TH 8E-480-BM



Parkrimp *No-Skive*  
one-piece fittings



ParLock  
two-piece skive fittings

# GLOBALCORE™

The world's first high-performance, cohesive hose and fitting system

## 722 / 722TC / 722ST *No-Skive* GlobalCore

### Resilient 4-wire spiral construction

#### Primary Applications

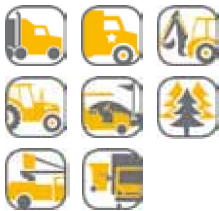

Parker's GlobalCore 722 spiral hose provides 28 MPa (4,000 psi) constant working pressure in sizes -6 through -16. Designed for high-pressure, high-impulse applications, 722 hose is offered in Standard, ToughCover and SuperTough cover options.

It is one-half the bend radius of 100R12 hose, making it easy to install and reducing the amount of hose needed. Exceeding the ISO 18752 performance specification, Parker's 722 hose excels in multiple applications around the world.

## 787 / 787TC *No-Skive* GlobalCore

### Lighter weight, high flexibility make installation easy

#### Primary Applications



Parker's GlobalCore 787 hose provides 35 MPa (5,000 psi) constant working pressure in all sizes. Compared with conventional spiral hose, 787 hose offers measurably greater advantages in routing and installation, product size and weight, inventory savings and much more. The 787 hose exceeds the ISO 18752 performance specification.

## 797 / 797TC *No-Skive* GlobalCore

### Lighter weight, high flexibility make installation easy

#### Primary Applications



Parker's GlobalCore 797 hose provides 42 MPa (6,000 psi) constant working pressure in all sizes. Compared with conventional spiral hose, 797 hose offers measurably greater advantages in routing and installation, product size and weight, inventory savings and much more. The 797 hose exceeds the ISO 18752 performance specification.



## GlobalCore significantly reduces system complexity



- ½ ISO 18752 minimum bend radius
- 28 MPa (4,000 psi) constant working pressure
- Exceeds ISO 18752 performance specification (BC and CC)
- 4-spiral construction for longer life in high-impulse, heavy-duty cycle applications
- TC cover provides 80 times the abrasion resistance compared to Standard rubber cover hoses
- ST cover provides 450 times the abrasion resistance compared to Standard rubber cover hoses



- ½ ISO 18752 minimum bend radius
- 35 MPa (5,000 psi) constant working pressure in all sizes
- Exceeds ISO 18752 performance specification (BC/DC)
- Nearly 30 % smaller O.D. by area than SAE spiral
- Twice the impulse/life – tested to 2,000,000 cycles
- Flex impulse tested, providing a hose superior in both performance and service life
- 30 % less hose weight than SAE spiral



- ½ the bend radius of SAE spiral
- 42 MPa (6,000 psi) constant working pressure in all sizes
- Exceeds ISO 18752 performance specification (BC/CC/DC)
- Nearly 30 % smaller O.D. by area than SAE spiral
- Twice the impulse/life – tested to 2,000,000 cycles
- Flex impulse tested, providing a hose superior in both performance and service life
- 30 % less hose weight than SAE spiral

# Full Flange System

Provides full flange mounting option for ISO 6162-1 (35.0 MPa/5000 psi) and ISO 6162-2 (42.0 MPa/ 6000 psi) flanges – system flexibility reduces inventory investment.

## The full flange system addresses the needs of customers by:

- Being easier to assemble
- Providing one-piece integrity
- Being easier to handle
- Being easier to route in tight spaces
- Enabling assemblies to be sent to customers with the flange in place
- Easing bent tube installation (displacement angle) with a freely rotating flange



The full flange system can be used repeatedly because of its patent-pending attachment system – the flange is not permanently locked onto the fitting.

- This is not a captive flange – it can easily be removed
- Flange can be reused if necessary
- Flange is not scrapped on a mis-crimp

## Fitting Configuration

This fitting configuration is specifically designed for Parker's full flange system, and will accept either a ISO 6162-1 or ISO 6162-2 flange. The X5, X7 and X9 fittings are designed to work with all Parkrimp crimpers. These fittings can replace multiple existing fittings and help to reduce inventory.

## Reduction of Inventory

Parker's full flange system requires less inventory than the existing split flange system.

By using the new X5, X7 and X9 fittings, distributors can streamline inventory and can still respond to customer needs. Before the introduction of the full flange system, distributors needed to stock both ISO 6162 fittings to be prepared.



### 1X577-20-20

Straight  
ISO 6162-1 or ISO 6162-2 fitting  
*Alternative to 15, 4A and 6A*

### 1X777-20-20

45°  
ISO 6162-1 or ISO 6162-2 fitting  
*Alternative to 17, 4F and 6F*

### 1X977-20-20

90°  
ISO 6162-1 or ISO 6162-2 fitting  
*Alternative to 19, 4N and 6N*

For more information about Full Flange System please refer to pages *Dd-18, Dd-19, Df-19, Df-20, Eb-4 and Eb-5*

## High Pressure GLOBALCORE™

Hoses			Page
<b>722</b> <i>No-Skive</i>	GlobalCore		Daa-1
<b>722TC</b> <i>No-Skive</i>	GlobalCore		Daa-2
<b>722ST</b> <i>No-Skive</i>	GlobalCore		Daa-3
<b>787</b> <i>No-Skive</i>	GlobalCore Compact Spiral		Daa-4
<b>787TC</b> <i>No-Skive</i>	GlobalCore Compact Spiral		Daa-5
<b>797</b> <i>No-Skive</i>	GlobalCore Compact Spiral		Daa-6
<b>797TC</b> <i>No-Skive</i>	GlobalCore Compact Spiral		Daa-7

<b>Fittings Series</b>	77
<b>Chapter</b>	Dd
<b>DIN – Metric</b>	1 – 4
<b>BSP</b>	5 – 8
<b>SAE</b>	9 – 11
<b>Flange</b>	12 – 22
<b>ORFS</b>	23 – 25
<b>French Standard</b>	26
<b>Special Fittings</b>	27

Parker Hannifin assumes no liability for typographical errors or other errors

# Parkrimp

## GlobalCore

<b>722</b> Daa-1  <i>No-Skive</i> GlobalCore Exceed ISO 18752-BC	<b>722TC</b> Daa-2  <i>No-Skive</i> GlobalCore Tough Cover Exceeds ISO 18752-CC	<b>722ST</b> Daa-3  <i>No-Skive</i> GlobalCore Super Tough Exceed ISO 18752-CC
<b>787</b> Daa-4  <i>No-Skive</i> GlobalCore Compact Spiral™ Exceeds ISO 18752-BC	<b>787TC</b> Daa-5  <i>No-Skive</i> GlobalCore Compact Spiral™ Exceeds ISO 18752-DC	
<b>797</b> Daa-6  <i>No-Skive</i> GlobalCore Compact Spiral™ Exceeds ISO 18752-BC	<b>797TC</b> Daa-7  <i>No-Skive</i> GlobalCore Compact Spiral™ Sizes -8 to -20 exceed ISO 18752-DC Sizes -24 and -32 exceed ISO 18752-CC	



# 722

## No-Skive GlobalCore

Exceed ISO 18752-BC



- *No-Skive* hose construction
- ½ ISO 18752 minimum bend radius
- 28 MPa constant working pressure
- Exceeds ISO 18752 BC performance specification
- 4-spiral construction for longer life in high-impulse, heavy-duty cycle applications

### Primary Applications

General high pressure hydraulic applications

### Applicable Specifications

Exceed ISO 18752-BC

### Construction

Tube: Synthetic rubber  
Reinforcement: Four spirals high-tensile steel wire  
Cover: Synthetic rubber

Temperature Range ..... -40 °C up to +100 °C

Exception: Air ..... max. +70 °C  
Water ..... max. +85 °C

### Recommended Fluids

Petroleum and water-glycol based fluids, lubricating oils, air and water. For air above 1.7 MPa, the hose cover must be pin-pricked.

Consult the chemical compatibility section on pages **Ab-26** to **Ab-34** for more detailed information.

### Fitting Series



Series 43 you'll find in the Medium Pressure chapter Cb

Part Number	Hose I.D.				Hose O.D. mm	Pressure Rating				min. bend radius mm	weight kg
	DN	Inch	Size	mm		max. working pressure		min. burst pressure			
						MPa	psi	MPa	psi		
722-6	10	3/8	-6	9.5	19.9	28.0	4000	112.0	16000	65	0.60
722-8	12	1/2	-8	12.7	22.7	28.0	4000	112.0	16000	90	0.80
722-10	16	5/8	-10	15.9	26.4	28.0	4000	112.0	16000	100	1.10
722-12	19	3/4	-12	19.1	30.7	28.0	4000	112.0	16000	120	1.40
722-16	25	1	-16	25.4	37.8	28.0	4000	112.0	16000	150	1.99

The combination of high temperature and high pressure could reduce the hose life.

### Hose layline example



# 722TC

## No-Skive GlobalCore Tough Cover

Exceeds ISO 18752-CC

### Primary Applications

General high pressure hydraulic applications

### Type Approvals

Details please find on pages **Ab-16** to **Ab-19**

### Applicable Specifications

SAE 100R12 – EN 856 Type R12 –

ISO 3862 Type R12

### Construction

Tube: Nitril (NBR)

Reinforcement: Four spirals high-tensile steel wire

Cover: High abrasion resistance  
MSHA approved synthetic rubber

Temperature Range ..... -40 °C up to +125 °C

Exception: Air ..... max. +70 °C

Water ..... max. +85 °C

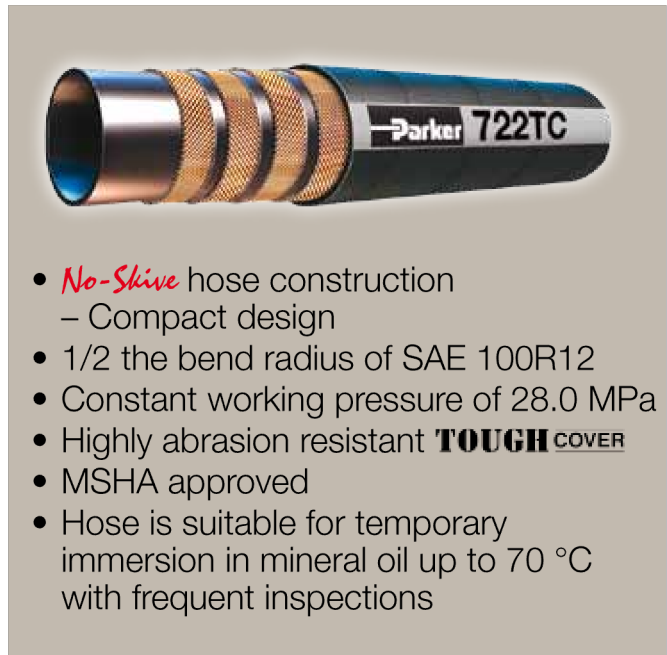

- **No-Skive** hose construction  
– Compact design
- 1/2 the bend radius of SAE 100R12
- Constant working pressure of 28.0 MPa
- Highly abrasion resistant **TOUGH COVER**
- MSHA approved
- Hose is suitable for temporary immersion in mineral oil up to 70 °C with frequent inspections

### Recommended Fluids

Petroleum and water-glycol based fluids, lubricating oils, air and water. For air above 1.7 MPa, the hose cover must be pin-pricked.

Consult the chemical compatibility section on pages **Ab-26** to **Ab-34** for more detailed information.

### Fitting Series



Series 43 you'll find in the Medium Pressure chapter Cb

Part Number	Hose I.D.				Hose O.D. mm	Pressure Rating				min. bend radius mm	weight kg
	DN	Inch	Size	mm		max. working pressure		min. burst pressure			
						MPa	psi	MPa	psi		
722TC-6	10	3/8	-6	9.5	19.9	28.0	4000	112.0	16000	65	0.60
722TC-8	12	1/2	-8	12.7	22.7	28.0	4000	112.0	16000	90	0.80
722TC-10	16	5/8	-10	15.9	26.4	28.0	4000	112.0	16000	100	1.10
722TC-12	19	3/4	-12	19.1	30.7	28.0	4000	112.0	16000	120	1.40
722TC-16	25	1	-16	25.4	37.8	28.0	4000	112.0	16000	150	1.99

Replace the hose when any deformation or damage on the hose cover are visible.  
The combination of high temperature and high pressure could reduce the hose life.

### Hose layline example



# 722ST

## No-Skive GlobalCore Super Tough

Exceeds ISO 18752-CC



- *No-Skive* hose construction
- ½ ISO 18752 minimum bend radius
- 28 MPa constant working pressure
- Exceeds ISO 18752 CC performance specification
- Extreme abrasion resistant **SUPER TOUGH** cover
- 4-spiral construction for longer life in high-impulse, heavy-duty cycle applications

### Primary Applications

General high pressure hydraulic applications

### Applicable Specifications

Exceed ISO 18752-CC

### Construction

- Tube: Synthetic rubber
- Reinforcement: Four spirals high-tensile steel wire
- Cover: Synthetic rubber with a special polyethylene coating

Temperature Range ..... -40 °C up to +125 °C

- Exception: Air ..... max. +70 °C
- Water ..... max. +85 °C

### Recommended Fluids

Petroleum and water-glycol based fluids, lubricating oils, air and water. For air above 1.7 MPa, the hose cover must be pin-pricked.

Consult the chemical compatibility section on pages **Ab-26** to **Ab-34** for more detailed information.

### Fitting Series



Series 43 you'll find in the Medium Pressure chapter Cb

Part Number	Hose I.D.				Hose O.D. mm	Pressure Rating				min. bend radius mm	weight kg
	DN	Inch	Size	mm		max. working pressure		min. burst pressure			
						MPa	psi	MPa	psi		
722ST-6	10	3/8	-6	9.5	19.9	28.0	4000	112.0	16000	65	0.60
722ST-8	12	1/2	-8	12.7	22.7	28.0	4000	112.0	16000	90	0.80
722ST-10	16	5/8	-10	15.9	26.4	28.0	4000	112.0	16000	100	1.10
722ST-12	19	3/4	-12	19.1	30.7	28.0	4000	112.0	16000	120	1.40
722ST-16	25	1	-16	25.4	37.8	28.0	4000	112.0	16000	150	1.99

The combination of high temperature and high pressure could reduce the hose life.

### Hose layline example



# 787

*No-Skive*

## GlobalCore Compact Spiral™

Exceeds ISO 18752-BC

### Primary Applications

On- & offshore, construction, injection moulding, mining

### Applicable Specifications

Exceeds ISO 18752-BC

### Construction

Tube: Proprietary synthetic rubber  
Reinforcement: Four or six spirals high-tensile steel wire  
Cover: Synthetic rubber

Temperature Range ..... -40 °C up to +100 °C

Exception: Air ..... max. +70 °C

Water ..... max. +85 °C



- 1/2 the bend radius of SAE 100R13
- Constant working pressure of 35.0 MPa
- Reduced O.D. and new construction lead to superior flexibility
- 1/3 less effort to bend
- Weight reduction – up to 26 %

### Recommended Fluids

Petroleum based hydraulic fluids and lubricating oils.  
Wide Compatibility exceeding Column III, with additional chemical resistance, especially for diesel and biodiesel.  
For chemical compatibility please contact  
HPDE\_helpdesk@parker.com

### Fitting Series



Part Number	Hose I.D.				Hose O.D. mm	Pressure Rating				min. bend radius mm	weight kg
	DN	Inch	Size	mm		max. working pressure		min. burst pressure			
						MPa	psi	MPa	psi		
787-8	12	1/2	-8	12.7	21.1	35.0	5000	140.0	20000	90	0.67
787-10	16	5/8	-10	15.9	23.9	35.0	5000	140.0	20000	100	0.80
787-12	19	3/4	-12	19.1	27.9	35.0	5000	140.0	20000	120	1.16
787-16	25	1	-16	25.4	35.7	35.0	5000	140.0	20000	150	1.74
787-20	31	1 1/4	-20	31.8	44.9	35.0	5000	140.0	20000	210	2.89
787-24	38	1 1/2	-24	38.1	52.8	35.0	5000	140.0	20000	255	3.96
787-32	51	2	-32	50.8	67.6	35.0	5000	140.0	20000	318	6.50

Replace the hose when any deformation or damage on the hose cover are visible.  
The combination of high temperature and high pressure could reduce the hose life.

### Hose layline example



# 787TC

No-Skive

## GlobalCore Compact Spiral™

Exceeds ISO 18752-DC

### Primary Applications

On- & offshore, construction, injection moulding, mining

### Type Approvals

Details please find on pages **Ab-16** to **Ab-19**

### Applicable Specifications

Exceeds SAE 100R13 – ISO 3862 Type R13 –  
EN 856 Type R13 – ISO 18752-DC

### Construction

Tube: Proprietary synthetic rubber  
Reinforcement: Four or six spirals high-tensile steel wire  
Cover: High abrasion resistance  
MSHA approved synthetic rubber

Temperature Range ..... -40 °C up to +125 °C

Exception: Air ..... max. +70 °C  
Water ..... max. +85 °C



- 1/2 the bend radius of SAE 100R13
- Constant working pressure of 35.0 MPa
- Reduced O.D. and new construction lead to superior flexibility
- 1/3 less effort to bend
- Weight reduction – up to 26 %
- Highly abrasion resistant **TOUGH COVER**
- MSHA approved
- Hose is suitable for temporary immersion in mineral oil up to 70 °C with frequent inspections

### Recommended Fluids

Petroleum based hydraulic fluids and lubricating oils.  
Wide Compatibility exceeding Column III, with additional chemical resistance, especially for diesel and biodiesel.  
For chemical compatibility please contact  
HPDE\_helpdesk@parker.com

### Fitting Series



Part Number	Hose I.D.				Hose O.D. mm	Pressure Rating				min. bend radius mm	weight kg
	DN	Inch	Size	mm		max. working pressure		min. burst pressure			
						MPa	psi	MPa	psi		
787TC-8	12	1/2	-8	12.7	21.1	35.0	5000	140.0	20000	90	0.67
787TC-10	16	5/8	-10	15.9	23.9	35.0	5000	140.0	20000	100	0.80
787TC-12	19	3/4	-12	19.1	27.9	35.0	5000	140.0	20000	120	1.16
787TC-16	25	1	-16	25.4	35.7	35.0	5000	140.0	20000	150	1.74
787TC-20	31	1 1/4	-20	31.8	44.9	35.0	5000	140.0	20000	210	2.89
787TC-24	38	1 1/2	-24	38.1	52.8	35.0	5000	140.0	20000	255	3.96
787TC-32	51	2	-32	50.8	67.6	35.0	5000	140.0	20000	318	6.50

Replace the hose when any deformation or damage on the hose cover are visible.  
The combination of high temperature and high pressure could reduce the hose life.

### Hose layline example



# 797

No-Skive

## GlobalCore Compact Spiral™

Exceeds ISO 18752-BC

### Primary Applications

On- & offshore, construction, injection moulding, mining

### Applicable Specifications

Exceeds ISO 18752-BC

### Construction

Tube: Proprietary synthetic rubber  
Reinforcement: Four or six spirals high-tensile steel wire  
Cover: Synthetic rubber

Temperature Range ..... -40 °C up to +100 °C

Exception: Air ..... max. +70 °C

Water ..... max. +85 °C



- 1/2 the bend radius of SAE 100R15
- Constant working pressure of 42.0 MPa
- Reduced O.D. and new construction lead to superior flexibility
- 1/3 less effort to bend
- Weight reduction – up to 26 %

### Recommended Fluids

Petroleum base hydraulic fluids and lubricating oils.  
Wide Compatibility exceeding Column III, with additional chemical resistance, especially for diesel and biodiesel.  
For chemical compatibility please contact  
HPDE\_helpdesk@parker.com

### Fitting Series



Part Number	Hose I.D.				Hose O.D. mm	Pressure Rating				min. bend radius mm	weight kg
	DN	Inch	Size	mm		max. working pressure		min. burst pressure			
						MPa	psi	MPa	psi		
797-8	12	1/2	-8	12.7	21.1	42.0	6000	168.0	24000	100	0.67
797-10	16	5/8	-10	15.9	23.9	42.0	6000	168.0	24000	115	0.80
797-12	19	3/4	-12	19.1	27.9	42.0	6000	168.0	24000	135	1.16
797-16	25	1	-16	25.4	35.7	42.0	6000	168.0	24000	165	1.74
797-20	31	1 1/4	-20	31.8	44.9	42.0	6000	168.0	24000	225	2.89
797-24	38	1 1/2	-24	38.1	52.8	42.0	6000	168.0	24000	305	3.96
797-32	51	2	-32	50.8	67.6	42.0	6000	168.0	24000	380	6.50

Replace the hose when any deformation or damage on the hose cover are visible.  
The combination of high temperature and high pressure could reduce the hose life.

### Hose layline example



# 797TC

No-Skive

## GlobalCore Compact Spiral™

Sizes -8 to -20 exceed ISO 18752-DC  
Sizes -24 and -32 exceed ISO 18752-CC

### Primary Applications

On- & offshore, construction, injection moulding, mining

### Type Approvals

Details please find on pages **Ab-16** to **Ab-19**

### Applicable Specifications

Exceeds SAE 100R15 – ISO 3862 Type R15 –  
ISO 18752-DC and CC

### Construction

Tube: Proprietary synthetic rubber  
Reinforcement: Four or six spirals high-tensile steel wire  
Cover: High abrasion resistance  
MSHA approved synthetic rubber

Temperature Range ..... -40 °C up to +125 °C

Exception: Air ..... max. +70 °C  
Water ..... max. +85 °C



- 1/2 the bend radius of SAE 100R15
- Constant working pressure of 42.0 MPa
- Reduced O.D. and new construction lead to superior flexibility
- 1/3 less effort to bend
- Weight reduction – up to 26 %
- Highly abrasion resistant **TOUGH COVER**
- MSHA approved
- Hose is suitable for temporary immersion in mineral oil up to 70 °C with frequent inspections

### Recommended Fluids

Petroleum base hydraulic fluids and lubricating oils.  
Wide Compatibility exceeding Column III, with additional chemical resistance, especially for diesel and biodiesel.  
For chemical compatibility please contact  
HPDE\_helpdesk@parker.com

### Fitting Series



Part Number	Hose I.D.				Hose O.D. mm	Pressure Rating				min. bend radius mm	weight kg
	DN	Inch	Size	mm		max. working pressure		min. burst pressure			
						MPa	psi	MPa	psi		
797TC-8	12	1/2	-8	12.7	21.1	42.0	6000	168.0	24000	100	0.67
797TC-10	16	5/8	-10	15.9	23.9	42.0	6000	168.0	24000	115	0.80
797TC-12	19	3/4	-12	19.1	27.9	42.0	6000	168.0	24000	135	1.16
797TC-16	25	1	-16	25.4	35.7	42.0	6000	168.0	24000	165	1.74
797TC-20	31	1 1/4	-20	31.8	44.9	42.0	6000	168.0	24000	225	2.89
797TC-24	38	1 1/2	-24	38.1	52.8	42.0	6000	168.0	24000	305	3.96
797TC-32	51	2	-32	50.8	67.6	42.0	6000	168.0	24000	380	6.50

Replace the hose when any deformation or damage on the hose cover are visible.  
The combination of high temperature and high pressure could reduce the hose life.

Hose layline example







## High Pressure

Hoses			Page
Parkrimp	<b>371LT</b> <i>No-Skive</i>	3-braids low temperature	Dab-1
	<b>372</b> <i>No-Skive</i>	3-braids standard	Dab-2
	<b>372RH</b> <i>No-Skive</i>	3-braids railway	Dab-3
	<b>372TC</b> <i>No-Skive</i>	3-braids high abrasion resistance	Dab-4
	<b>701</b> <i>No-Skive</i>	Standard	Dab-5
	<b>701TC</b> <i>No-Skive</i>	High abrasion resistance	Dab-6
	<b>722ClF</b> <i>No-Skive</i>	Chlorine Free	Dab-7
	<b>722LT</b> <i>No-Skive</i>	Low Temperature	Dab-8
	<b>722TC</b> <i>No-Skive</i>	High abrasion resistance	Dab-9
	<b>722ST</b> <i>No-Skive</i>	Extreme abrasion resistance	Dab-10
	<b>731</b> <i>No-Skive</i>	Standard	Dab-11
	<b>731TC</b> <i>No-Skive</i>	High abrasion resistance	Dab-12
	<b>774</b> <i>No-Skive</i>	Phosphate Ester	Dab-13
	<b>F42</b> <i>No-Skive</i>	Phosphate Ester	Dab-14
ParLock	<b>H29</b>	Standard	Dab-15
	<b>H29RH</b>	Railway	Dab-16
	<b>H29TC</b>	High abrasion resistance	Dab-17
	<b>H29ST</b>	Extreme abrasion resistance	Dab-18
	<b>H31</b>	Standard	Dab-19
	<b>H31TC</b>	High abrasion resistance	Dab-20
	<b>H31ST</b>	Extreme abrasion resistance	Dab-21
	<b>R35</b>	Standard	Dab-22
	<b>R35TC/RS35TC-48</b>	High abrasion resistance	Dab-23
	<b>R42</b>	Standard	Dab-24
	<b>R42TC</b>	High abrasion resistance	Dab-25
	<b>R42ST</b>	Extreme abrasion resistance	Dab-26
	<b>R50TC/R56TC</b>	High abrasion resistance	Dab-27
	<b>BPK</b>	Water-Blasting	Dab-28

Fittings Series	Parkrimp			ParLock			
	70	73	77	VS	V4/V6	V5	WB
Chapter	Db	Dc	Dd	De	Df	Dg	Dh
Shell				1	1	1	1
DIN – Metric	1–4	1–2	1–4	2–5	2–5	2–3	2
BSP	5–7	3–4	5–8	6–7	6–8		3
SAE	8–10	5–7	9–11	8–10	9–11		4
Flange	11–14	8–12	12–22	11–13	12–22		
ORFS	15–17	13–15	23–25	14–15	23–25		
JIS	18						
French Standard	19	16–17	26	16	26		
Others	20						
Special Fittings		19	27				

Parker Hannifin assumes no liability for typographical errors or other errors

## Parkrimp

### 3-braids standard



### 3-braids low temperature



### 3-braids high abrasion resistance



### 3-braids railway



# Parkrimp

## Standard

<b>701</b> Dab-6  <b>No-Skive Multispiral</b> ISO 3862 Type 4SP – EN 856 Type 4SP	<b>731</b> Dab-11  <b>No-Skive Multispiral</b> ISO 3862 Type 4SH – EN 856 Type 4SH
--	---

## Low temperature

<b>722LT</b> Dab-8  <b>No-Skive Low-temperature spiral</b> SAE 100R12/ISO 3862-1 TypeR12 /EN 856 Type R12
--

## Phosphate Ester

<b>774</b> Dab-13  <b>No-Skive Multispiral</b> For phosphate ester base fluids	<b>F42</b> Dab-14  <b>No-Skive Multispiral</b> For phosphate ester base fluids
--	--

## Chlorine Free

<b>722CLF</b> Dab-7  <b>No-Skive Chlorine Free</b> SAE 100R12 - EN 856 Type R12 - ISO 3862 Type R12
--

## High abrasion resistance

<b>701TC</b> Dab-6  <b>No-Skive Multispiral Tough Cover</b> ISO 3862 Type 4SP – EN 856 Type 4SP	<b>722TC</b> Dab-9  <b>No-Skive Tough Cover</b> Exceeds ISO 18752-CC	<b>731TC</b> Dab-12  <b>No-Skive Multispiral</b> ISO 3862 Type 4SH – EN 856 Type 4SH
--	---	--

## Extreme abrasion resistance

<b>722ST</b> Dab-10  <b>No-Skive Super Tough</b> Exceed ISO 18752-CC
---

# ParLock

## Standard

<b>H29</b> Dab-15  <b>ParLock Multispiral</b> Exceeds ISO 3862 Type 4SH – EN 856 Type 4SH	<b>H31</b> Dab-19  <b>ParLock Multispiral</b> Exceeds ISO 3862 Type 4SP – EN 856 Type 4SP	<b>R35</b> Dab-22  <b>ParLock Multispiral</b> Exceeds ISO 3862 Type R13 – Parker Specifications	<b>R42</b> Dab-24  <b>ParLock Multispiral</b> Exceeds ISO 3862 Type R15 – Parker Specifications
---	---	--	---

## High abrasion resistance

<b>H29TC</b> Dab-17  <b>ParLock Multispiral</b> Exceeds ISO 3862 Type 4SH – EN 856 Type 4SH	<b>H31TC</b> Dab-20  <b>ParLock Multispiral</b> Exceeds ISO 3862 Type 4SP – EN 856 Type 4SP	<b>R35TC/RS35TC-48</b> Dab-23  <b>ParLock Multispiral</b> Exceeds ISO 3862 Type R13 – Parker Specifications	<b>R42TC</b> Dab-25  <b>ParLock Multispiral</b> Exceeds ISO 3862 Type R15 – Parker Specifications
<b>R50TC/R56TC</b> Dab-27  <b>ParLock Multispiral</b> Exceeds ISO 3862 Type R15 – Parker Specifications			

## Extreme abrasion resistance

<b>H29ST</b> Dab-18  <b>ParLock Multispiral</b> Exceeds ISO 3862 Type 4SH – EN 856 Type 4SH	<b>H31ST</b> Dab-21  <b>ParLock Multispiral</b> Exceeds ISO 3862 Type 4SP – EN 856 Type 4SP	<b>R42ST</b> Dab-26  <b>ParLock Multispiral</b> Exceeds ISO 3862 Type R15 – Parker Specifications
---	---	--

## Railway

<b>H29RH</b> Dab-16  <b>ParLock Multispiral</b> Fire-retardant cover – exceeds ISO 3862 Type 4SH – EN 856 Type 4SH
--

## Water-Blasting

<b>BPK</b> Dab-28  <b>Blastopak ParLock Multispiral</b> DIN EN 1829-2
--

# 371LT

## No-Skive Compact

3-wire braid low-temperature compact hose with 4SP working pressures

### Primary Applications

Mobile applications in low temperature environments:  
Forestry machines, refrigerated warehouses

### Applicable Specifications

Parker Specifications

### Construction

Tube: Synthetic rubber  
Reinforcement: Three high-tensile steel wire braids  
Cover: Synthetic rubber

Temperature Range ..... -50 °C up to +100 °C

Exception: Air ..... max. +70 °C  
Water ..... max. +85 °C

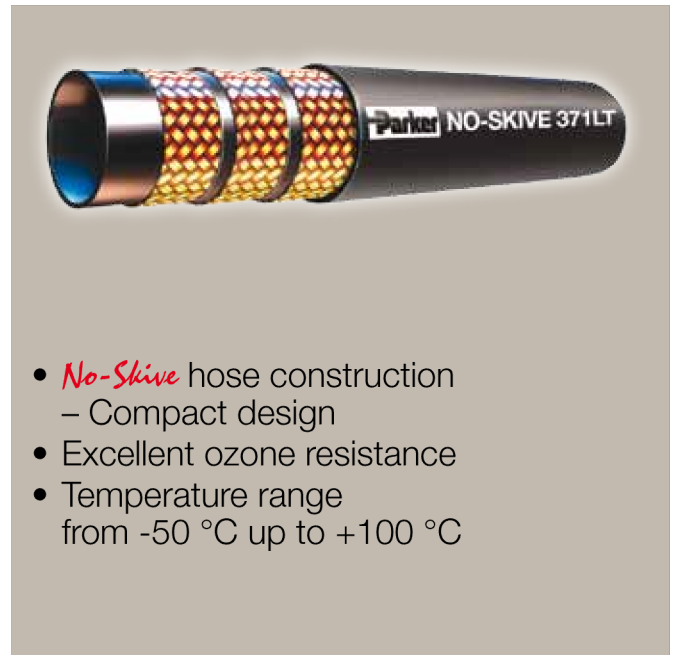

- *No-Skive* hose construction – Compact design
- Excellent ozone resistance
- Temperature range from -50 °C up to +100 °C

### Recommended Fluids

Petroleum and water-glycol based fluids, lubricating oils, air and water. For air above 1.7 MPa, the hose cover must be pin-pricked.

Consult the chemical compatibility section on pages **Ab-26** to **Ab-34** for more detailed information.

### Fitting Series



Part Number	Hose I.D.				Hose O.D. mm	Pressure Rating				min. bend radius mm	weight kg
	DN	Inch	Size	mm		max. working pressure		min. burst pressure			
						MPa	psi	MPa	psi		
371LT-6	10	3/8	-6	9.5	21.4	44.5	6500	178.0	25800	120	0.73
371LT-8	12	1/2	-8	12.7	24.6	41.5	6000	166.0	24000	160	0.90
371LT-10	16	5/8	-10	15.9	28.2	35.0	5000	140.0	20000	210	1.09
371LT-12	19	3/4	-12	19.1	32.2	35.0	5000	140.0	20000	260	1.36
371LT-16	25	1	-16	25.4	39.7	28.0	4000	112.0	16000	310	1.78

The combination of high temperature and high pressure could reduce the hose life.

Hose layline example



# 372

## No-Skive Compact

3-wire braid compact hose with  
4SP working pressures

### Primary Applications

General high pressure small bending radii hydraulic applications

### Type Approvals

Details please find on pages **Ab-16** to **Ab-19**

### Applicable Specifications

Parker Specifications

### Construction

Tube: Nitrile (NBR)  
Reinforcement: Three high-tensile steel wire braids  
Cover: Synthetic rubber

Temperature Range ..... -40 °C up to +100 °C

Exception: Air ..... max. +70 °C

Water ..... max. +85 °C



- *No-Skive* hose construction – Compact design
- Nitrile (NBR) inner tube for extended fluid compatibility

### Recommended Fluids

Petroleum and water-glycol based fluids, lubricating oils, air and water. For air above 1.7 MPa, the hose cover must be pin-pricked.

Consult the chemical compatibility section on pages **Ab-26** to **Ab-34** for more detailed information.

### Fitting Series



Part Number	Hose I.D.				Hose O.D. mm	Pressure Rating				min. bend radius mm	weight kg
	DN	Inch	Size	mm		max. working pressure		min. burst pressure			
						MPa	psi	MPa	psi		
372-6	10	3/8	-6	9.5	21.4	44.5	6500	178.0	25800	120	0.73
372-8	12	1/2	-8	12.7	24.6	41.5	6000	166.0	24000	160	0.90
372-10	16	5/8	-10	15.9	28.2	35.0	5000	140.0	20000	210	1.09
372-12	19	3/4	-12	19.1	32.2	35.0	5000	140.0	20000	260	1.36
372-16	25	1	-16	25.4	39.7	28.0	4000	112.0	16000	310	1.78

The combination of high temperature and high pressure could reduce the hose life.

### Hose layline example



# 372RH

## No-Skive Compact

3-wire braid with fire-retardant cover

### Primary Applications

Dynamic and static high-pressure hydraulic systems

### Type Approvals

Details please find on pages **Ab-16** to **Ab-19**

### Applicable Specifications

Parker specifications

Working pressure and O.D. to EN 856-4SP

### Construction

Tube: Nitrile (NBR)

Reinforcement: Three high-tensile steel wire braids

Cover: Fire retardant synthetic rubber

Temperature Range ..... -40 °C up to +100 °C

Exception: Air ..... max. +70 °C

Water ..... max. +85 °C



- **No-Skive** hose construction
- Nitrile (NBR) inner tube  
– high chemical resistance
- Small bend radii
- Fire-retardant cover
- German Standard: **DIN 5510-2**
- French Standard: **NF F16-101/102 I2/F3**
- British Standard: **BS 6853 - Table 4**

### Recommended Fluids

Petroleum and water-glycol based fluids, lubricating oils, air and water. For air above 1.7 MPa, the hose cover must be pin-pricked.

Consult the chemical compatibility section on pages **Ab-26** to **Ab-34** for more detailed information.

### Fitting Series



Part Number	Hose I.D.				Hose O.D. mm	Pressure Rating				min. bend radius mm	weight kg
	DN	Inch	Size	mm		max. working pressure		min. burst pressure			
						MPa	psi	MPa	psi		
372RH-6	10	3/8	-6	9.5	21.4	44.5	6500	178.0	25800	120	0.73
372RH-8	12	1/2	-8	12.7	24.6	41.5	6000	166.0	24000	160	0.90
372RH-10	16	5/8	-10	15.9	28.2	35.0	5000	140.0	20000	210	1.09
372RH-12	19	3/4	-12	19.1	32.2	35.0	5000	140.0	20000	260	1.36
372RH-16	25	1	-16	25.4	39.7	28.0	4000	112.0	16000	310	1.78

The combination of high temperature and high pressure could reduce the hose life.

### Hose layline example

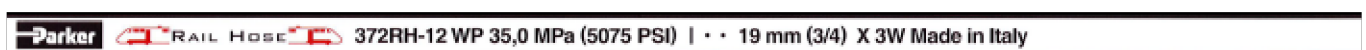

# 372TC

## No-Skive Compact

3-wire braid compact hose with 4SP working pressures

### Primary Applications

General high pressure hydraulic applications (typically in the mobile industry)

### Type Approvals

Details please find on pages **Ab-16** to **Ab-19**

### Applicable Specifications

Parker specifications – working pressures and outside diameters according to EN 856-4SP

### Construction

Tube: Nitrile (NBR)  
Reinforcement: Three high-tensile steel wire braids  
Cover: Highly abrasion resistant  
MSHA approved synthetic rubber

Temperature Range ..... -40 °C up to +100 °C

Exception: Air ..... max. +70 °C  
Water ..... max. +85 °C

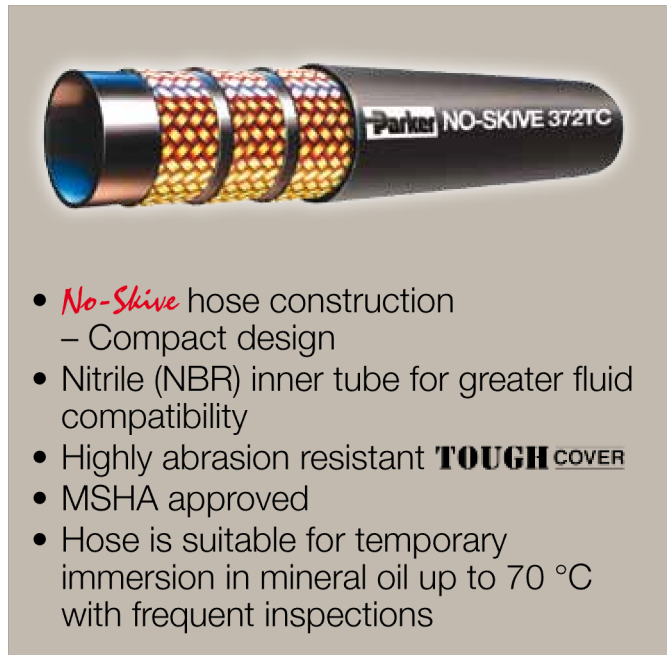

- **No-Skive** hose construction – Compact design
- Nitrile (NBR) inner tube for greater fluid compatibility
- Highly abrasion resistant **TOUGH COVER**
- MSHA approved
- Hose is suitable for temporary immersion in mineral oil up to 70 °C with frequent inspections

### Recommended Fluids

Petroleum and water-glycol based fluids, lubricating oils, air and water. For air above 1.7 MPa, the hose cover must be pin-pricked.

Consult the chemical compatibility section on pages **Ab-26** to **Ab-34** for more detailed information.

### Fitting Series



Part Number	Hose I.D.				Hose O.D. mm	Pressure Rating				min. bend radius mm	weight kg
	DN	Inch	Size	mm		max. working pressure		min. burst pressure			
						MPa	psi	MPa	psi		
372TC-6	10	3/8	-6	9.5	21.4	44.5	6500	178.0	25800	120	0.73
372TC-8	12	1/2	-8	12.7	24.6	41.5	6000	166.0	24000	160	0.90
372TC-10	16	5/8	-10	15.9	28.2	35.0	5000	140.0	20000	210	1.09
372TC-12	19	3/4	-12	19.1	32.2	35.0	5000	140.0	20000	260	1.36
372TC-16	25	1	-16	25.4	39.7	28.0	4000	112.0	16000	310	1.78

Replace the hose when any deformation or damage on the hose cover are visible. The combination of high temperature and high pressure could reduce the hose life.

Hose layline example





# 701

## No-Skive Multispiral

ISO 3862 Type 4SP – EN 856 Type 4SP

### Primary Applications

General high pressure hydraulic applications

### Type Approvals

Details please find on pages **Ab-16** to **Ab-19**

### Applicable Specifications

ISO 3862 Type 4SP – EN 856 Type 4SP

### Construction

- Tube: Synthetic rubber
- Reinforcement: Four spirals high-tensile steel wire
- Cover: Synthetic rubber

Temperature Range ..... -40 °C up to +100 °C

- Exception: Air ..... max. +70 °C
- Water ..... max. +85 °C



- *No-Skive* hose construction
- Reinforcement of four high tensile steel wires

### Recommended Fluids

Petroleum and water-glycol based fluids, lubricating oils, air and water. For air above 1.7 MPa, the hose cover must be pin-pricked.

Consult the chemical compatibility section on pages **Ab-26** to **Ab-34** for more detailed information.

### Fitting Series



Part Number	Hose I.D.				Hose O.D. mm	Pressure Rating				min. bend radius mm	weight kg
	DN	Inch	Size	mm		max. working pressure		min. burst pressure			
						MPa	psi	MPa	psi		
701-6	10	3/8	-6	9.5	21.4	45.0	6500	180.0	26000	180	0.78
701-8	12	1/2	-8	12.7	24.6	41.5	6000	166.0	24000	230	0.93
701-10	16	5/8	-10	15.9	28.2	35.0	5000	140.0	20000	250	1.15
701-12	19	3/4	-12	19.1	32.2	35.0	5000	140.0	20000	300	1.58
701-16	25	1	-16	25.4	39.7	28.0	4000	112.0	16000	340	2.04

The combination of high temperature and high pressure could reduce the hose life.

Hose layline example



# 701TC

## No-Skive Multispiral Tough Cover

ISO 3862 Type 4SP – EN 856 Type 4SP

### Primary Applications

General high pressure hydraulic applications

### Type Approvals

Details please find on pages **Ab-16** to **Ab-19**

### Applicable Specifications

ISO 3862 Type 4SP – EN 856 Type 4SP

### Construction

Tube: Synthetic rubber  
Reinforcement: Four spirals high-tensile steel wire  
Cover: Highly abrasion resistant  
MSHA approved synthetic rubber

Temperature Range ..... -40 °C up to +100 °C

Exception: Air ..... max. +70 °C  
Water ..... max. +85 °C



- *No-Skive* hose construction
- Reinforcement of four high tensile steel wires
- Highly abrasion resistant **TOUGH COVER**
- MSHA approved
- Hose is suitable for temporary immersion in mineral oil up to 70 °C with frequent inspections

### Recommended Fluids

Petroleum and water-glycol based fluids, lubricating oils, air and water. For air above 1.7 MPa, the hose cover must be pin-pricked.

Consult the chemical compatibility section on pages **Ab-26** to **Ab-34** for more detailed information.

### Fitting Series



Part Number	Hose I.D.				Hose O.D. mm	Pressure Rating				min. bend radius mm	weight kg
	DN	Inch	Size	mm		max. working pressure		min. burst pressure			
						MPa	psi	MPa	psi		
701TC-6	10	3/8	-6	9.5	21.4	45.0	6500	180.0	26000	180	0.78
701TC-8	12	1/2	-8	12.7	24.6	41.5	6000	166.0	24000	230	0.93
701TC-10	16	5/8	-10	15.9	28.2	35.0	5000	140.0	20000	250	1.15
701TC-12	19	3/4	-12	19.1	32.2	35.0	5000	140.0	20000	300	1.58
701TC-16	25	1	-16	25.4	39.7	28.0	4000	112.0	16000	340	2.04

The combination of high temperature and high pressure could reduce the hose life.

### Hose layline example



# 722CLF

## No-Skive Chlorine Free

SAE 100R12 - EN 856 Type R12 -  
ISO 3862 Type R12

### Primary Applications

Transportation, construction, forestry

### Applicable Specifications

SAE 100R12 – EN 856 Type R12 –  
ISO 3862Type R12

### Construction

Tube: Chlorine free Nitril (NBR)  
Reinforcement: Four spirals high-tensile steel wire  
Cover: Chlorine free synthetic rubber

Temperature Range ..... -40 °C up to +125 °C

Exception: Air ..... max. +70 °C  
Water ..... max. +85 °C



- *No-Skive* hose construction – Compact design
- 1/2 the bend radius of SAE 100R12
- Constant working pressure of 28.0 MPa
- Chlorine free compounds

### Recommended Fluids

Petroleum and water-glycol based fluids, lubricating oils, air and water. For air above 1.7 MPa, the hose cover must be pin-pricked.

Consult the chemical compatibility section on pages **Ab-26** to **Ab-34** for more detailed information.

### Fitting Series



Series 43 you'll find in the Medium Pressure chapter Cb

Part Number	Hose I.D.				Hose O.D. mm	Pressure Rating				min. bend radius mm	weight kg
	DN	Inch	Size	mm		max. working pressure MPa	psi	min. burst pressure MPa	psi		
722CLF-6	10	3/8	-6	9.5	19.9	28.0	4000	112	16000	65	0.60
722CLF-8	12	1/2	-8	12.7	22.7	28.0	4000	112	16000	90	0.80
722CLF-10	16	5/8	-10	15.9	26.4	28.0	4000	112	16000	100	1.10
722CLF-12	19	3/4	-12	19.1	30.7	28.0	4000	112	16000	120	1.40
722CLF-16	25	1	-16	25.4	37.8	28.0	4000	112	16000	150	1.99

Replace the hose when any deformation or damage on the hose cover are visible.  
The combination of high temperature and high pressure could reduce the hose life.

Hose layline example

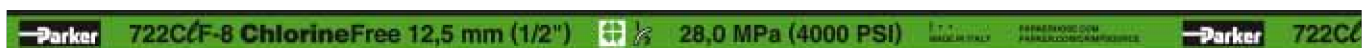

# 722LT

*No-Skive* Low temperature spiral hose  
for extreme cold conditions

## Primary Applications

Snow grooming equipment, heavy construction equipment, sideboos

## Type Approvals

Details please find on pages **Ab-16** to **Ab-19**

## Applicable Specifications

SAE 100R12 – ISO 3862-1 Type R12 –  
EN 856 Type R12

## Construction

Tube: Nitrile (NBR)  
Reinforcement: Four spirals high-tensile steel wire  
Cover: Synthetic rubber

Temperature Range ..... -57 °C up to +100 °C



- *No-Skive* hose construction
- Temperature Range from -57 °C up to 100 °C
- Constant working pressure of 28.0 MPa
- Compatible with petroleum
- 1/2 the bend radius of SAE 100R12

## Recommended Fluids

Petroleum based hydraulic fluids and lubricating.  
Consult the chemical compatibility section on pages **Ab-26** to **Ab-34** for more detailed information.

## Fitting Series

Series 43 for size -6 up to -20  
Size -24 on request

Series 43 you'll find in the Medium Pressure chapter Cb



Part Number	Hose I.D.				Hose O.D. mm	Pressure Rating				min. bend radius mm	weight kg
	DN	Inch	Size	mm		max. working pressure		min. burst pressure			
						MPa	psi	MPa	psi		
722LT-6	10	3/8	-6	9.5	19.9	28.0	4000	112.0	16000	65	0.60
722LT-8	12	1/2	-8	12.7	22.7	28.0	4000	112.0	16000	90	0.80
722LT-10	16	5/8	-10	15.9	26.4	28.0	4000	112.0	16000	100	1.10
722LT-12	19	3/4	-12	19.1	30.7	28.0	4000	112.0	16000	120	1.40
722LT-16	25	1	-16	25.4	37.8	28.0	4000	112.0	16000	150	1.99
722LT-20	31	1 1/4	-20	31.8	46.2	21.0	3000	84.0	12000	210	2.59
722LT-24	38	1 1/2	-24	38.1	52.5	17.5	2500	70.0	10000	250	2.99

Replace the hose when any deformation or damage on the hose cover are visible.  
The combination of high temperature and high pressure could reduce the hose life.

# 722TC

## No-Skive Tough Cover

Exceeds ISO 18752-CC

### Primary Applications

General high pressure hydraulic applications

### Type Approvals

Details please find on pages **Ab-16** to **Ab-19**

### Applicable Specifications

SAE 100R12 – EN 856 Type R12 –  
ISO 3862 Type R12

### Construction

- Tube: Nitrile (NBR)
- Reinforcement: Four spirals high-tensile steel wire
- Cover: High abrasion resistance  
MSHA approved synthetic rubber

Temperature Range ..... -40 °C up to +125 °C

- Exception: Air ..... max. +70 °C
- Water ..... max. +85 °C

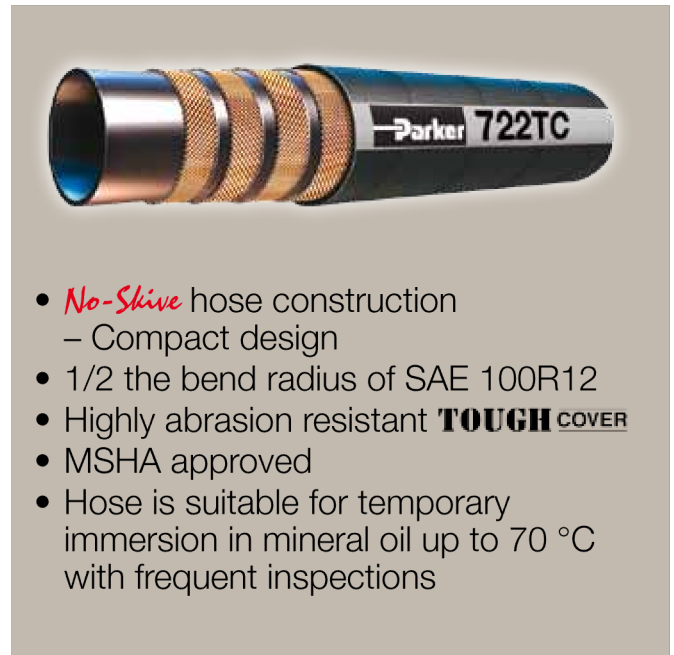

- **No-Skive** hose construction  
– Compact design
- 1/2 the bend radius of SAE 100R12
- Highly abrasion resistant **TOUGH COVER**
- MSHA approved
- Hose is suitable for temporary immersion in mineral oil up to 70 °C with frequent inspections

### Recommended Fluids

Petroleum and water-glycol based fluids, lubricating oils, air and water. For air above 1.7 MPa, the hose cover must be pin-pricked.

Consult the chemical compatibility section on pages **Ab-26** to **Ab-34** for more detailed information.

### Fitting Series

- Series 43 only for size -20
- Size -24 and -32 on request
- Series 43 you'll find in the Medium Pressure chapter Cb



Part Number	Hose I.D.				Hose O.D. mm	Pressure Rating				min. bend radius mm	weight kg
	DN	Inch	Size	mm		max. working pressure		min. burst pressure			
						MPa	psi	MPa	psi		
722TC-20	31	1 1/4	-20	31.8	46	21.0	3000	84.0	12000	210	2.59
722TC-24	38	1 1/2	-24	38.1	53	17.5	2500	70.0	10000	250	2.99
722TC-32	51	2	-32	50.8	66	17.5	2500	70.0	10000	320	4.09

Replace the hose when any deformation or damage on the hose cover are visible. The combination of high temperature and high pressure could reduce the hose life.

Hose layline example



# 722ST

## No-Skive Super Tough

Exceeds ISO 18752-CC



- *No-Skive* hose construction
- ½ ISO 18752 minimum bend radius
- Exceeds ISO 18752 CC performance specification
- Extreme abrasion resistant **SUPER TOUGH** cover
- 4-spiral construction for longer life in high-impulse, heavy-duty cycle applications

### Primary Applications

General high pressure hydraulic applications

### Applicable Specifications

Exceed ISO 18752-CC

### Construction

Tube: Synthetic rubber  
Reinforcement: Four spirals high-tensile steel wire  
Cover: Synthetic rubber with a special polyethylene coating

Temperature Range ..... -40 °C up to +125 °C

Exception: Air ..... max. +70 °C  
Water ..... max. +85 °C

### Recommended Fluids

Petroleum and water-glycol based fluids, lubricating oils, air and water. For air above 1.7 MPa, the hose cover must be pin-pricked.

Consult the chemical compatibility section on pages **Ab-26** to **Ab-34** for more detailed information.

### Fitting Series

Series 43 only for size -20

Size -24 and -32 on request

Series 43 you'll find in the Medium Pressure chapter Cb



Part Number	Hose I.D.				Hose O.D. mm	Pressure Rating				min. bend radius mm	weight kg
	DN	Inch	Size	mm		max. working pressure		min. burst pressure			
						MPa	psi	MPa	psi		
722ST-20	31	1 1/4	-20	31.8	46	21.0	3000	84.0	12000	210	2.59
722ST-24	38	1 1/2	-24	38.1	53	17.5	2500	70.0	10000	250	2.99
722ST-32	51	2	-32	50.8	66	17.5	2500	70.0	10000	320	4.09

The combination of high temperature and high pressure could reduce the hose life.

### Hose layline example



# 731

## No-Skive Multispiral

ISO 3862 Type 4SH – EN 856 Type 4SH



- *No-Skive* hose construction
- Reinforcement of four high tensile steel wires

### Primary Applications

General high pressure hydraulic applications

### Applicable Specifications

ISO 3862 Type 4SH – EN 856 Type 4SH

### Construction

Tube: Synthetic rubber  
 Reinforcement: Four spirals high-tensile steel wire  
 Cover: Synthetic rubber

Temperature Range ..... -40 °C up to +100 °C

Exception: Air ..... max. +70 °C  
 Water ..... max. +85 °C

### Recommended Fluids

Petroleum and water-glycol based fluids, lubricating oils, air and water. For air above 1.7 MPa, the hose cover must be pin-pricked.

Consult the chemical compatibility section on pages **Ab-26** to **Ab-34** for more detailed information.

### Fitting Series



Part Number	Hose I.D.				Hose O.D. mm	Pressure Rating				min. bend radius mm	weight kg
	DN	Inch	Size	mm		max. working pressure		min. burst pressure			
						MPa	psi	MPa	psi		
731-12	19	3/4	-12	19.1	32.0	42.0	6000	168.0	24000	280	1.72
731-16	25	1	-16	25.4	39.0	38.0	5500	152.0	22000	340	2.14
731-20	31	1 1/4	-20	31.8	45.0	32.0	4700	130.0	18800	460	2.96
731-24	38	1 1/2	-24	38.1	53.0	29.0	4200	116.0	16800	560	3.20
731-32	51	2	-32	50.8	68.0	25.0	3600	100.0	14400	700	5.30

The combination of high temperature and high pressure could reduce the hose life.

Hose layline example

**Parker** NO-SKIVE 731-12 WP 42,0 MPa (6000 PSI) MSHA XXXX 19 mm (3/4) X 4S EN 856-4SH/20/4Q91



# 731TC

## No-Skive Multispiral

ISO 3862 Type 4SH – EN 856 Type 4SH

### Primary Applications

General high pressure hydraulic applications

### Type Approvals

Details please find on pages **Ab-16** to **Ab-19**

### Applicable Specifications

ISO 3862 Type 4SH – EN 856 Type 4SH

### Construction

Tube: Synthetic rubber  
Reinforcement: Four spirals high-tensile steel wire  
Cover: High abrasion resistance  
MSHA approved synthetic rubber

Temperature Range ..... -40 °C up to +100 °C

Exception: Air ..... max. +70 °C  
Water ..... max. +85 °C



- **No-Skive** hose construction
- Reinforcement of four high tensile steel wires
- Highly abrasion resistant **TOUGH COVER**
- MSHA approved
- Hose is suitable for temporary immersion in mineral oil up to 70 °C with frequent inspections

### Recommended Fluids

Petroleum and water-glycol based fluids, lubricating oils, air and water. For air above 1.7 MPa, the hose cover must be pin-pricked.

Consult the chemical compatibility section on pages **Ab-26** to **Ab-34** for more detailed information.

### Fitting Series



Part Number	Hose I.D.				Hose O.D. mm	Pressure Rating				min. bend radius mm	weight kg
	DN	Inch	Size	mm		max. working pressure		min. burst pressure			
						MPa	psi	MPa	psi		
731TC-12	19	3/4	-12	19.1	32.0	42.0	6000	168.0	24000	280	1.72
731TC-16	25	1	-16	25.4	39.0	38.0	5500	152.0	22000	340	2.14
731TC-20	31	1 1/4	-20	31.8	45.0	32.0	4700	130.0	18800	460	2.96
731TC-24	38	1 1/2	-24	38.1	53.0	29.0	4200	116.0	16800	560	3.20
731TC-32	51	2	-32	50.8	68.0	25.0	3600	100.0	14400	700	5.30

Replace the hose when any deformation or damage on the hose cover are visible.  
The combination of high temperature and high pressure could reduce the hose life.

Hose layline example

**Parker TOUGH COVER 731TC-12 WP 42.0 MPa (6000 PSI) MSHA IC 40/26 | • • 19 mm (3/4) X 4S EN856-4SH**



# 774

## No-Skive Multispiral

For phosphate ester base fluids

### Primary Applications

Test stands for aerospace, foundries, steel mills  
High pressure hydraulic applications with phosphate ester fluids

### Restrictions

Do not allow tube to contact any petroleum base fluids.  
Use liquid soap as hose lubricant.

### Applicable Specifications

Parker specifications

### Construction

Tube: Phosphate ester resistant EPDM synthetic rubber  
Reinforcement: Four spirals high-tensile steel wire  
Cover: Phosphate ester and weather resistant, green, EPDM synthetic rubber cover

Temperature Range ..... -40 °C up to +80 °C



- *No-Skive* hose construction
- Phosphate ester and weather resistant, green, EPDM synthetic rubber cover

### Recommended Fluids

Phosphate ester base hydraulic fluids.  
Consult the chemical compatibility section on pages **Ab-26** to **Ab-34** for more detailed information.

Fitting Series

on request

Part Number	Hose I.D.				Hose O.D. mm	Pressure Rating				min. bend radius mm	weight kg
	DN	Inch	Size	mm		max. working pressure		min. burst pressure			
						MPa	psi	MPa	psi		
774-12	19	3/4	-12	19.1	31.0	28.0	4000	112.0	16000	240	1.40
774-16	25	1	-16	25.4	38.0	28.0	4000	112.0	16000	300	1.99
774-20	31	1 1/4	-20	31.8	47.0	21.0	3000	84.0	12000	420	2.59
774-24	38	1 1/2	-24	38.1	53.0	17.5	2500	70.0	10000	500	2.99
774-32	51	2	-32	50.8	67.0	17.5	2500	70.0	10000	630	4.09

The combination of high temperature and high pressure could reduce the hose life.

Hose layline example

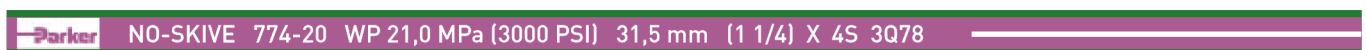

# F42

## No-Skive Multispiral

For phosphate ester base fluids

### Primary Applications

Test stands for aerospace, foundries, steel mills  
High pressure hydraulic applications with phosphate ester fluids

### Applicable Specifications

Parker Specification

### Restrictions

Do not allow tube to contact any petroleum base fluids.  
Use liquid soap as hose lubricant.

### Construction

Tube: Phosphate ester resistant EPDM synthetic rubber  
Reinforcement: Four or six spirals high-tensile steel wire  
Cover: Phosphate ester and weather resistant, green, EPDM synthetic rubber cover

Temperature Range ..... -40 °C up to +80 °C

Exception: Air ..... max. +70 °C

Water ..... max. +85 °C



- *No-Skive* hose construction
- Phosphate ester and weather resistant, green, EPDM synthetic rubber cover
- Constant working pressure of 42.0 MPa

### Recommended Fluids

Phosphate ester based hydraulic fluids, water-glycol based fluids, air and water.

Consult the chemical compatibility section on pages **Ab-26** to **Ab-34** for more detailed information.

### Fitting Series

Series 70 only for size -8  
Size -12 up to size -20 on request



Part Number	Hose I.D.				Hose O.D. mm	Pressure Rating				min. bend radius mm	weight kg
	DN	Inch	Size	mm		max. working pressure		min. burst pressure			
						MPa	psi	MPa	psi		
F42-8	12	1/2	-8	12.7	25.0	42.0	6000	168.0	24000	200	0.83
F42-12	19	3/4	-12	19.1	31.9	42.0	6000	168.0	24000	265	1.53
F42-16	25	1	-16	25.4	38.5	42.0	6000	168.0	24000	330	2.08
F42-20	31	1 1/4	-20	31.8	50	42.0	6000	168.0	24000	445	3.96

The combination of high temperature and high pressure could reduce the hose life.

Hose layline example

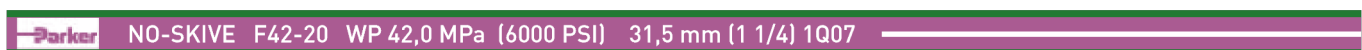

# H29

## ParLock Multispiral

Exceeds ISO 3862 Type 4SH –  
EN 856 Type 4SH

### Primary Applications

General high pressure hydraulic applications

### Type Approvals

Details please find on pages **Ab-16** to **Ab-19**

### Applicable Specifications

Exceeds ISO 3862 Type 4SH – EN 856 Type 4SH

### Construction

- Tube: Synthetic rubber
- Reinforcement: Four spirals high-tensile steel wire
- Cover: Synthetic rubber

Temperature Range ..... -40 °C up to +100 °C

- Exception: Air ..... max. +70 °C
- Water ..... max. +85 °C



- Interlock technology
- Reinforcement of four high tensile steel wires

### Recommended Fluids

Petroleum and water-glycol based fluids, lubricating oils, air and water. For air above 1.7 MPa, the hose cover must be pin-pricked.

Consult the chemical compatibility section on pages **Ab-26** to **Ab-34** for more detailed information.

### Fitting Series

Internal and external skiving



Part Number	Hose I.D.				Hose O.D. mm	Pressure Rating				min. bend radius mm	weight kg
	DN	Inch	Size	mm		max. working pressure		min. burst pressure			
						MPa	psi	MPa	psi		
H29-12	19	3/4	-12	19.1	32.2	43.0	6250	172.0	25000	280	1.7
H29-16	25	1	-16	25.4	38.7	40.0	5800	160.0	23200	340	2.2
H29-20	31	1 1/4	-20	31.8	45.5	35.0	5000	140.0	20000	460	2.6
H29-24	38	1 1/2	-24	38.1	53.5	31.0	4500	124.0	18000	560	3.4
H29-32	51	2	-32	50.8	68.1	28.0	4050	112.0	16200	700	4.8

The combination of high temperature and high pressure could reduce the hose life.

Hose layline example

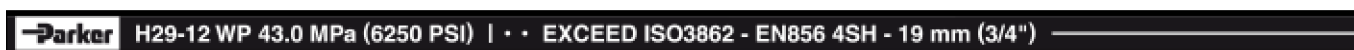

# H29RH

## ParLock Multispiral

Fire-retardant cover – exceeds  
ISO 3862 Type 4SH – EN 856 Type 4SH

### Primary Applications

General high pressure hydraulic applications

### Type Approvals

Details please find on pages **Ab-16** to **Ab-19**

### Applicable Specifications

Exceeds ISO 3862 Type 4SH – EN 856 Type 4SH

### Construction

Tube: Synthetic rubber  
Reinforcement: Four spirals high-tensile steel wire  
Cover: Fire retardant synthetic rubber

Temperature Range ..... -40 °C up to +100 °C

Exception: Air ..... max. +70 °C  
Water ..... max. +85 °C



- Interlock technology
- Reinforcement of four high tensile steel wires
- Fire-retardant cover
- French Standard: **NF F16-101/102 I2/F3**
- British Standard: **BS 6853 - Table 4**

### Recommended Fluids

Petroleum and water-glycol based fluids, lubricating oils, air and water. For air above 1.7 MPa, the hose cover must be pin-pricked.

Consult the chemical compatibility section on pages **Ab-26** to **Ab-34** for more detailed information.

### Fitting Series

Internal and external skiving



Part Number	Hose I.D.				Hose O.D. mm	Pressure Rating				min. bend radius mm	weight kg
	DN	Inch	Size	mm		max. working pressure		min. burst pressure			
						MPa	psi	MPa	psi		
H29RH-16	25	1	-16	25.4	38.7	40.0	5800	160.0	23200	340	2.2
H29RH-20	31	1 1/4	-20	31.8	45.5	35.0	5000	140.0	20000	460	2.6
H29RH-24	38	1 1/2	-24	38.1	53.5	31.0	4500	124.0	18000	560	3.4

The combination of high temperature and high pressure could reduce the hose life.

Hose layline example

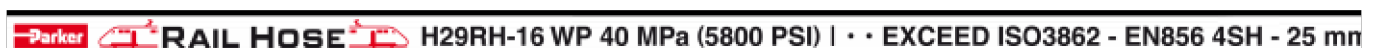

# H29TC

## ParLock Multispiral

Exceeds ISO 3862 Type 4SH –  
EN 856 Type 4SH

### Primary Applications

General high pressure hydraulic applications

### Type Approvals

Details please find on pages **Ab-16** to **Ab-19**

### Applicable Specifications

Exceeds ISO 3862 Type 4SH – EN 856 Type 4SH

### Construction

- Tube: Synthetic rubber
- Reinforcement: Four spirals high-tensile steel wire
- Cover: High abrasion resistance  
MSHA approved synthetic rubber

Temperature Range ..... -40 °C up to +100 °C

- Exception: Air ..... max. +70 °C
- Water ..... max. +85 °C



- Interlock technology
- Reinforcement of four high tensile steel wires
- Highly abrasion resistant **'TOUGH COVER'**
- MSHA approved
- Hose is suitable for temporary immersion in mineral oil up to 70 °C with frequent inspections

### Recommended Fluids

Petroleum and water-glycol based fluids, lubricating oils, air and water. For air above 1.7 MPa, the hose cover must be pin-pricked.

Consult the chemical compatibility section on pages **Ab-26** to **Ab-34** for more detailed information.

### Fitting Series

Internal and external skiving



Part Number	Hose I.D.				Hose O.D. mm	Pressure Rating				min. bend radius mm	weight kg
	DN	Inch	Size	mm		max. working pressure		min. burst pressure			
						MPa	psi	MPa	psi		
H29TC-12	19	3/4	-12	19.1	32.2	43.0	6250	172.0	25000	280	1.7
H29TC-16	25	1	-16	25.4	38.7	40.0	5800	160.0	23200	340	2.2
H29TC-20	31	1 1/4	-20	31.8	45.5	35.0	5000	140.0	20000	460	2.6
H29TC-24	38	1 1/2	-24	38.1	53.5	31.0	4500	124.0	18000	560	3.4
H29TC-32	51	2	-32	50.8	68.1	28.0	4050	112.0	16200	700	4.8

The combination of high temperature and high pressure could reduce the hose life.

Hose layline example

**Parker TOUGH COVER H29TC-12 WP 43,0 MPa (6250 PSI) MSHA IC 40/26 | • EXCEED ISO3862 - EN856**



# H29ST

## ParLock Multispiral

Exceeds ISO 3862 Type 4SH – EN 856 Type 4SH

### Primary Applications

General high pressure hydraulic applications

### Type Approvals

Details please find on pages **Ab-16** to **Ab-19**

### Applicable Specifications

Exceeds ISO 3862 Type 4SH – EN 856 Type 4SH

### Construction

Tube: Synthetic rubber  
Reinforcement: Four spirals high-tensile steel wire  
Cover: Synthetic rubber  
with a special polyethylene coating

Temperature Range ..... -40 °C up to +100 °C

Exception: Air ..... max. +70 °C  
Water ..... max. +85 °C



- Interlock technology
- Extreme abrasion resistant **SUPER TOUGH** cover
- Reinforcement of four high tensile steel wires

### Recommended Fluids

Petroleum and water-glycol based fluids, lubricating oils, air and water. For air above 1.7 MPa, the hose cover must be pin-pricked.

Consult the chemical compatibility section on pages **Ab-26** to **Ab-34** for more detailed information.

### Fitting Series

Internal and external skiving



Part Number	Hose I.D.				Hose O.D. mm	Pressure Rating				min. bend radius mm	weight kg
	DN	Inch	Size	mm		max. working pressure		min. burst pressure			
						MPa	psi	MPa	psi		
H29ST-12	19	3/4	-12	19.1	32.2	43.0	6250	172.0	25000	280	1.7
H29ST-16	25	1	-16	25.4	38.7	40.0	5800	160.0	23200	340	2.2
H29ST-20	31	1 1/4	-20	31.8	45.5	35.0	5000	140.0	20000	460	2.6
H29ST-24	38	1 1/2	-24	38.1	53.5	31.0	4500	124.0	18000	560	3.4
H29ST-32	51	2	-32	50.8	68.1	28.0	4050	112.0	16200	700	4.8

Replace the hose when any deformation or damage on the hose cover are visible.  
The combination of high temperature and high pressure could reduce the hose life.

Hose layline example

**Parker SUPER TOUGH H29ST-12 WP 43,0 MPa (6250 PSI) | · · EXCEED ISO3862 - EN856 4SH**

# H31

## ParLock Multispiral

Exceeds ISO 3862 Type 4SP –  
EN 856 Type 4SP

### Primary Applications

General high pressure hydraulic applications

### Type Approvals

Details please find on pages **Ab-16** to **Ab-19**

### Applicable Specifications

Exceeds ISO 3862 Type 4SP – EN 856 Type 4SP

### Construction

Tube: Synthetic rubber  
Reinforcement: Four spirals high-tensile steel wire  
Cover: Synthetic rubber

Temperature Range ..... -40 °C up to +100 °C

Exception: Air ..... max. +70 °C  
Water ..... max. +85 °C

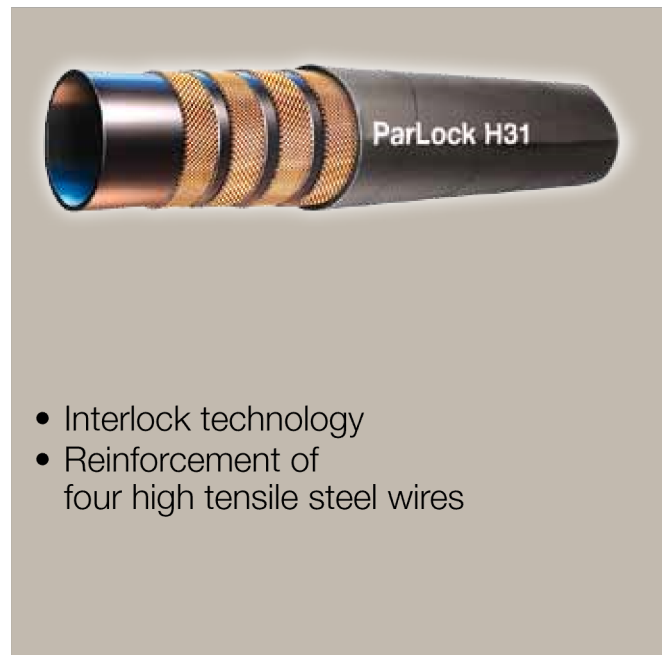

- Interlock technology
- Reinforcement of four high tensile steel wires

### Recommended Fluids

Petroleum and water-glycol based fluids, lubricating oils, air and water. For air above 1.7 MPa, the hose cover must be pin-pricked.

Consult the chemical compatibility section on pages **Ab-26** to **Ab-34** for more detailed information.

### Fitting Series

External skiving (size -4 up to -8)

Internal and external skiving (size -10 up to -16)



Part Number	Hose I.D.				Hose O.D. mm	Pressure Rating				min. bend radius mm	weight kg
	DN	Inch	Size	mm		max. working pressure		min. burst pressure			
						MPa	psi	MPa	psi		
H31-4	6	1/4	-4	6.4	17.8	50.0	7250	200.0	29000	120	0.73
H31-6	10	3/8	-6	9.5	21.4	44.5	6450	178.0	25800	130	0.91
H31-8	12	1/2	-8	12.7	24.6	41.5	6000	166.0	24000	180	1.08
H31-10	16	5/8	-10	15.9	28.5	39.0	5650	156.0	22600	225	1.39
H31-12	19	3/4	-12	19.1	32.0	35.0	5000	140.0	20300	280	1.73
H31-16	25	1	-16	25.4	39.7	31.0	4500	124.0	18000	355	2.31

The combination of high temperature and high pressure could reduce the hose life.

Hose layline example

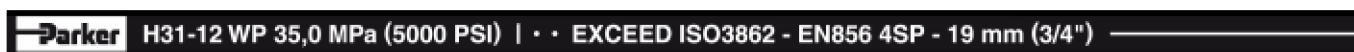

# H31TC

## ParLock Multispiral

Exceeds ISO 3862 Type 4SP – EN 856 Type 4SP

### Primary Applications

General high pressure hydraulic applications

### Type Approvals

Details please find on pages **Ab-16** to **Ab-19**

### Applicable Specifications

Exceeds ISO 3862 Type 4SP – EN 856 Type 4SP

### Construction

Tube: Synthetic rubber  
Reinforcement: Four spirals high-tensile steel wire  
Cover: High abrasion resistance  
MSHA approved synthetic rubber

Temperature Range ..... -40 °C up to +100 °C

Exception: Air ..... max. +70 °C  
Water ..... max. +85 °C



- Interlock technology
- Reinforcement of four high tensile steel wires
- Highly abrasion resistant **TOUGH COVER**
- MSHA approved
- Hose is suitable for temporary immersion in mineral oil up to 70 °C with frequent inspections

### Recommended Fluids

Petroleum and water-glycol based fluids, lubricating oils, air and water. For air above 1.7 MPa, the hose cover must be pin-pricked.

Consult the chemical compatibility section on pages **Ab-26** to **Ab-34** for more detailed information.

### Fitting Series

External skiving (size -4 up to -8)

Internal and external skiving (size -10 up to -16)



Part Number	Hose I.D.				Hose O.D. mm	Pressure Rating				min. bend radius mm	weight kg
	DN	Inch	Size	mm		max. working pressure		min. burst pressure			
						MPa	psi	MPa	psi		
H31TC-4	6	1/4	-4	6.4	17.8	50.0	7250	200.0	29000	120	0.73
H31TC-6	10	3/8	-6	9.5	21.4	44.5	6450	178.0	25800	130	0.91
H31TC-8	12	1/2	-8	12.7	24.6	41.5	6000	166.0	24000	180	1.08
H31TC-10	16	5/8	-10	15.9	28.5	39.0	5650	156.0	22600	225	1.39
H31TC-12	19	3/4	-12	19.1	32.0	35.0	5000	140.0	20300	280	1.73
H31TC-16	25	1	-16	25.4	39.7	31.0	4500	124.0	18000	355	2.31

Replace the hose when any deformation or damage on the hose cover are visible. The combination of high temperature and high pressure could reduce the hose life.

Hose layline example

**Parker TOUGH COVER H31TC-6 WP 44,5 MPa (6450 PSI) MSHA IC 40/26 | • • EXCEED ISO3862 - EN856 4SP**



# H31ST

## ParLock Multispiral

Exceeds ISO 3862 Type 4SP –  
EN 856 Type 4SP

### Primary Applications

General high pressure hydraulic applications

### Type Approvals

Details please find on pages **Ab-16** to **Ab-19**

### Applicable Specifications

Exceeds ISO 3862 Type 4SP – EN 856 Type 4SP

### Construction

- Tube: Synthetic rubber
- Reinforcement: Four spirals high-tensile steel wire
- Cover: Synthetic rubber  
with a special polyethylene coating

Temperature Range ..... -40 °C up to +100 °C

- Exception: Air ..... max. +70 °C
- Water ..... max. +85 °C



- Interlock technology
- Extreme abrasion resistant  
**SUPER TOUGH** cover
- Reinforcement of  
four high tensile steel wires

### Recommended Fluids

Petroleum and water-glycol based fluids, lubricating oils, air and water. For air above 1.7 MPa, the hose cover must be pin-pricked.  
Consult the chemical compatibility section on pages **Ab-26** to **Ab-34** for more detailed information.

### Fitting Series

External skiving (size -4 up to -8)

Internal and external skiving (size -10 up to -16)



Part Number	Hose I.D.				Hose O.D. mm	Pressure Rating				min. bend radius mm	weight kg
	DN	Inch	Size	mm		max. working pressure		min. burst pressure			
						MPa	psi	MPa	psi		
H31ST-4	6	1/4	-4	6.4	17.8	50.0	7250	200.0	29000	120	0.73
H31ST-6	10	3/8	-6	9.5	21.4	44.5	6450	178.0	25800	130	0.91
H31ST-8	12	1/2	-8	12.7	24.6	41.5	6000	166.0	24000	180	1.08
H31ST-10	16	5/8	-10	15.9	28.5	39.0	5650	156.0	22600	225	1.39
H31ST-12	19	3/4	-12	19.1	32.0	35.0	5000	140.0	20300	280	1.73
H31ST-16	25	1	-16	25.4	39.7	31.0	4500	124.0	18000	355	2.31

The combination of high temperature and high pressure could reduce the hose life.

Hose layline example



## R35

### ParLock Multispiral

Exceeds ISO 3862 Type R13 –  
Parker Specifications

#### Primary Applications

General high pressure hydraulic applications

#### Type Approvals

Details please find on pages **Ab-16** to **Ab-19**

#### Applicable Specifications

Exceeds ISO 3862 Type R13 – Parker Specifications

#### Construction

Tube: Synthetic rubber  
Reinforcement: Four or six spirals high-tensile steel wire  
Cover: Synthetic rubber

Temperature Range ..... -40 °C up to +125 °C

Exception: Air ..... max. +70 °C  
Water ..... max. +85 °C



- Interlock technology
- Reinforcement of four or six high tensile steel wires
- Constant working pressure of 35.0 MPa

#### Recommended Fluids

Petroleum and water-glycol based fluids, lubricating oils, air and water. For air above 1.7 MPa, the hose cover must be pin-pricked.

Consult the chemical compatibility section on pages **Ab-26** to **Ab-34** for more detailed information.

#### Fitting Series

Internal and external skiving (size -12, -16, -20)



Internal and external skiving (size -24, -32)

Part Number	Hose I.D.				Hose O.D. mm	Pressure Rating				min. bend radius mm	weight kg
	DN	Inch	Size	mm		max. working pressure		min. burst pressure			
						MPa	psi	MPa	psi		
R35-12	19	3/4	-12	19.1	32.00	35.0	5000	140.0	20000	220	1.5
R35-16	25	1	-16	25.4	39.35	35.0	5000	140.0	20000	280	2.2
R35-20	31	1 1/4	-20	31.8	45.50	35.0	5000	140.0	20000	380	2.6
R35-24	38	1 1/2	-24	38.1	57.30	35.0	5000	140.0	20000	480	4.8
R35-32	51	2	-32	50.8	71.10	35.0	5000	140.0	20000	600	6.7

The combination of high temperature and high pressure could reduce the hose life.

Hose layline example

**Parker** R35-16 WP 35.0 MPa (5000 PSI) | · · EXCEED ISO3862 - SAE100R13 - 25 mm (1")

# R35TC/RS35TC-48

## ParLock Multispiral

Exceeds ISO 3862 Type R13 – Parker Specifications

### Primary Applications

General high pressure hydraulic applications

### Type Approvals

Details please find on pages **Ab-16** to **Ab-19**

### Applicable Specifications

Exceeds ISO 3862 Type R13 – Parker Specifications

### Construction

- Tube: Synthetic rubber
- Reinforcement: Four or six spirals high-tensile steel wire
- Cover: High abrasion resistance  
MSHA approved synthetic rubber

Temperature Range ..... -40 °C up to +125 °C

- Exception: Air ..... max. +70 °C
- Water ..... max. +85 °C

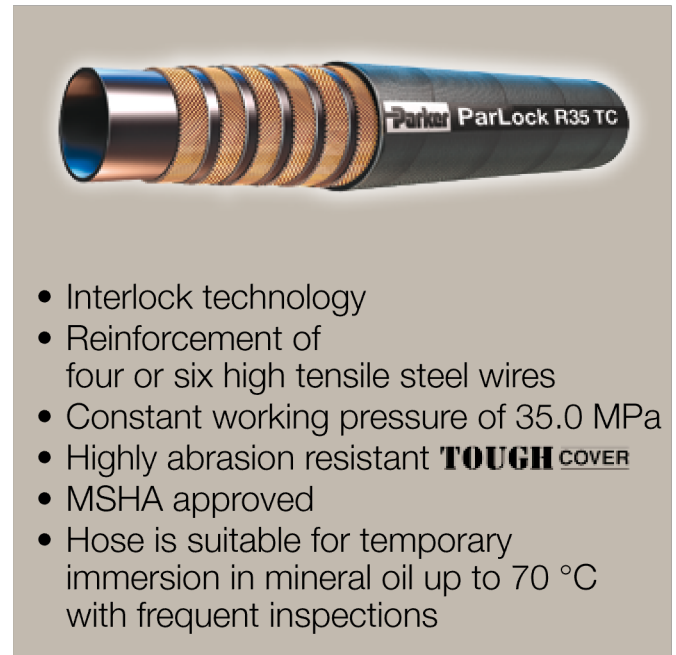

- Interlock technology
- Reinforcement of four or six high tensile steel wires
- Constant working pressure of 35.0 MPa
- Highly abrasion resistant **TOUGH COVER**
- MSHA approved
- Hose is suitable for temporary immersion in mineral oil up to 70 °C with frequent inspections

### Recommended Fluids

Petroleum and water-glycol based fluids, lubricating oils, air and water. For air above 1.7 MPa, the hose cover must be pin-pricked.

Consult the chemical compatibility section on pages **Ab-26** to **Ab-34** for more detailed information.

### Fitting Series

Internal and external skiving (size -12 up to -20)



Internal and external skiving (size -24 up to -48)



Part Number	Hose I.D.				Hose O.D. mm	Pressure Rating				min. bend radius mm	weight kg
	DN	Inch	Size	mm		max. working pressure		min. burst pressure			
						MPa	psi	MPa	psi		
R35TC-12	19	3/4	-12	19.1	32.00	35.0	5000	140.0	20000	220	1.5
R35TC-16	25	1	-16	25.4	39.35	35.0	5000	140.0	20000	280	2.2
R35TC-20	31	1 1/4	-20	31.8	45.50	35.0	5000	140.0	20000	380	2.6
R35TC-24	38	1 1/2	-24	38.1	57.30	35.0	5000	140.0	20000	480	4.8
R35TC-32	51	2	-32	50.8	71.10	35.0	5000	140.0	20000	600	6.7
R35TC-40	63	2 1/2	-40	63.5	84.50	35.0	5000	140.0	20000	800	9.0
RS35TC-48	76	3	-48	76.2	96.00	35.0*	5000*	88.0	12750	900	10.0
RS35TC-48	76	3	-48	76.2	96.00	21.0**	3040**	88.0	12750	900	10.0

Replace the hose when any deformation or damage on the hose cover are visible. The combination of high temperature and high pressure could reduce the hose life.

\* 35 MPa: Static applications according to ISO 6807-D

\*\* 21 MPa: Dynamic hydraulic application design factor > 4:1

### Hose layline example



# R42

## ParLock Multispiral

Exceeds ISO 3862 Type R15 –  
Parker Specifications

### Primary Applications

General high pressure hydraulic applications

### Type Approvals

Details please find on pages **Ab-16** to **Ab-19**

### Applicable Specifications

Exceeds ISO 3862 Type R15 – Parker Specifications

### Construction

Tube: Synthetic rubber  
Reinforcement: Four or six spirals high-tensile steel wire  
Cover: Synthetic rubber

Temperature Range ..... -40 °C up to +125 °C

Exception: Air ..... max. +70 °C  
Water ..... max. +85 °C



- Interlock technology
- Reinforcement of four or six high tensile steel wires
- Constant working pressure of 42.0 MPa

### Recommended Fluids

Petroleum and water-glycol based fluids, lubricating oils, air and water. For air above 1.7 MPa, the hose cover must be pin-pricked.

Consult the chemical compatibility section on pages **Ab-26** to **Ab-34** for more detailed information.

### Fitting Series

Internal and external skiving (size -10, -12, -16)



Internal and external skiving (size -20, -24, -32)



Part Number	Hose I.D.				Hose O.D. mm	Pressure Rating				min. bend radius mm	weight kg
	DN	Inch	Size	mm		max. working pressure		min. burst pressure			
						MPa	psi	MPa	psi		
R42-10	16	5/8	-10	15.9	28.50	42.0	6000	168.0	24000	225	1.39
R42-12	19	3/4	-12	19.1	32.00	42.0	6000	168.0	24000	280	1.70
R42-16	25	1	-16	25.4	39.00	42.0	6000	168.0	24000	300	2.30
R42-20	31	1 1/4	-20	31.8	50.75	42.0	6000	168.0	24000	400	3.80
R42-24	38	1 1/2	-24	38.1	57.00	42.0	6000	168.0	24000	500	4.80
R42-32	51	2	-32	50.8	71.50	42.0	6000	168.0	24000	700	7.00

The combination of high temperature and high pressure could reduce the hose life.

Hose layline example



## R42TC

### ParLock Multispiral

Exceeds ISO 3862 Type R15 – Parker Specifications

#### Primary Applications

General high pressure hydraulic applications

#### Type Approvals

Details please find on pages **Ab-16** to **Ab-19**

#### Applicable Specifications

Exceeds ISO 3862 Type R15 – Parker Specifications

#### Construction

Tube: Synthetic rubber  
Reinforcement: Four or six spirals high-tensile steel wire  
Cover: High abrasion resistance  
MSHA approved synthetic rubber

Temperature Range ..... -40 °C up to +125 °C

Exception: Air ..... max. +70 °C  
Water ..... max. +85 °C



- Interlock technology
- Reinforcement of four or six high tensile steel wires
- Constant working pressure of 42.0 MPa
- Highly abrasion resistant **TOUGH COVER**
- MSHA approved
- Hose is suitable for temporary immersion in mineral oil up to 70 °C with frequent inspections

#### Recommended Fluids

Petroleum and water-glycol based fluids, lubricating oils, air and water. For air above 1.7 MPa, the hose cover must be pin-pricked.

Consult the chemical compatibility section on pages **Ab-26** to **Ab-34** for more detailed information.

#### Fitting Series

Internal and external skiving (size -10, -12, -16)



Internal and external skiving (size -20, -24, -32)

Part Number	Hose I.D.				Hose O.D. mm	Pressure Rating				min. bend radius mm	weight kg
	DN	Inch	Size	mm		max. working pressure		min. burst pressure			
						MPa	psi	MPa	psi		
R42TC-10	16	5/8	-10	15.9	28.50	42.0	6000	168.0	24000	225	1.39
R42TC-12	19	3/4	-12	19.1	32.00	42.0	6000	168.0	24000	280	1.70
R42TC-16	25	1	-16	25.4	39.00	42.0	6000	168.0	24000	300	2.30
R42TC-20	31	1 1/4	-20	31.8	50.75	42.0	6000	168.0	24000	400	3.80
R42TC-24	38	1 1/2	-24	38.1	57.00	42.0	6000	168.0	24000	500	4.80
R42TC-32	51	2	-32	50.8	71.50	42.0	6000	168.0	24000	700	7.00

Replace the hose when any deformation or damage on the hose cover are visible.  
The combination of high temperature and high pressure could reduce the hose life.

Hose layline example

**Parker TOUGH COVER R42TC-32 WP 42.0 MPa (6000 PSI) MSHA IC 40/26 | • • ISO 3862 - SAE100R**

# R42ST

## ParLock Multispiral

Exceeds ISO 3862 Type R15 – Parker Specifications

### Primary Applications

General high pressure hydraulic applications

### Type Approvals

Details please find on pages **Ab-16** to **Ab-19**

### Applicable Specifications

Exceeds ISO 3862 Type R15 – Parker Specifications

### Construction

Tube: Synthetic rubber  
Reinforcement: Four or six spirals high-tensile steel wire  
Cover: Synthetic rubber with a special polyethylene coating

Temperature Range ..... -40 °C up to +125 °C

Exception: Air ..... max. +70 °C  
Water ..... max. +85 °C



- Interlock technology
- Extreme abrasion resistant **SUPER TOUGH** cover
- Reinforcement of four or six high tensile steel wires
- Constant working pressure of 42.0 MPa

### Recommended Fluids

Petroleum and water-glycol based fluids, lubricating oils, air and water. For air above 1.7 MPa, the hose cover must be pin-pricked.

Consult the chemical compatibility section on pages **Ab-26** to **Ab-34** for more detailed information.

### Fitting Series

Internal and external skiving (size -10, -12, -16)



Internal and external skiving (size -20, -24, -32)

Part Number	Hose I.D.				Hose O.D. mm	Pressure Rating				min. bend radius mm	weight kg
	DN	Inch	Size	mm		max. working pressure		min. burst pressure			
						MPa	psi	MPa	psi		
R42ST-10	16	5/8	-10	15.9	28.50	42.0	6000	168.0	24000	225	1.39
R42ST-12	19	3/4	-12	19.1	32.00	42.0	6000	168.0	24000	280	1.70
R42ST-16	25	1	-16	25.4	39.00	42.0	6000	168.0	24000	300	2.30
R42ST-20	31	1 1/4	-20	31.8	50.75	42.0	6000	168.0	24000	400	3.80
R42ST-24	38	1 1/2	-24	38.1	57.00	42.0	6000	168.0	24000	500	4.80
R42ST-32	51	2	-32	50.8	71.50	42.0	6000	168.0	24000	700	7.00

The combination of high temperature and high pressure could reduce the hose life.

Hose layline example



# R50TC/R56TC

## ParLock Multispiral

Exceeds ISO 3862 Type R15 – Parker Specifications

### Primary Applications

Mobile hydraulic equipment and agricultural machines with typically large constructions.

### Type Approvals

Details please find on pages **Ab-16** to **Ab-19**

### Applicable Specifications

Exceeds ISO 3862 Type R15 – Parker Specifications

### Construction

- Tube: Synthetic rubber
- Reinforcement: Four or six spirals high-tensile steel wire
- Cover: High abrasion resistance  
MSHA approved synthetic rubber

Temperature Range ..... -40 °C up to +100 °C

- Exception: Air ..... max. +70 °C
- Water ..... max. +85 °C



- Interlock technology
- Reinforcement of four or six high tensile steel wires
- Constant working pressure of 50.0 MPa (R50TC) and 56.0 MPa (R56TC)
- Highly abrasion resistant **TOUGH COVER**
- MSHA approved
- Hose is suitable for temporary immersion in mineral oil up to 70 °C with frequent inspections

### Recommended Fluids

Petroleum and water-glycol based fluids, lubricating oils, air and water. For air above 1.7 MPa, the hose cover must be pin-pricked.

Consult the chemical compatibility section on pages **Ab-26** to **Ab-34** for more detailed information.

**Fitting Series** Internal and external skiving  
R56TC-6 and R56TC-8

R50TC-10 up to -16

R50TC-20



Part Number	Hose I.D.				Hose O.D. mm	Pressure Rating				min. bend radius mm	weight kg
	DN	Inch	Size	mm		max. working pressure		min. burst pressure			
						MPa	psi	MPa	psi		
R56TC-6	10	3/8	-6	9.5	21.8	56.0	8100	224.0	32400	130	0.95
R56TC-8	12	1/2	-8	12.7	25.5	56.0	8100	224.0	32400	180	1.25
R50TC-10	16	5/8	-10	15.9	28.50	50.0	7250	200.0	29000	225	1.48
R50TC-12	19	3/4	-12	19.1	32.00	50.0	7250	200.0	29000	270	1.85
R50TC-16	25	1	-16	25.4	38.40	50.0	7250	200.0	29000	300	2.70
R50TC-20	31	1 1/4	-20	31.8	52.60	50.0	7250	200.0	29000	450	5.00

Replace the hose when any deformation or damage on the hose cover are visible. The combination of high temperature and high pressure could reduce the hose life.

Hose layline example

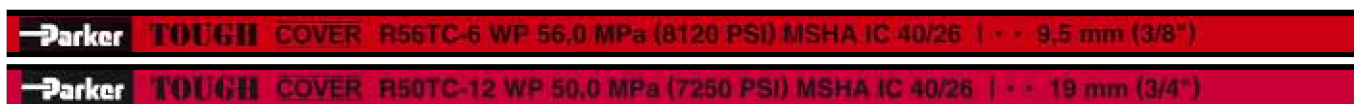

# BPK

## Blastopak ParLock Multispiral

DIN EN 1829-2



### Primary Applications

Water blasting applications, water cutting applications, cleaning and paint or corrosion removal.

Not recommended for dynamic hydraulic applications

### Applicable Specifications

Exceeds ISO 3862 Type R15 – Parker Specifications

### Construction

Tube: Synthetic rubber

Reinforcement: Four or six spirals high-tensile steel wire

Cover: Synthetic rubber

### Continuous Service Temperature Range

-10 °C up to +70 °C

### Max. Service Temperature Range

-40 °C up to +93 °C



- Interlock technology
- Reinforcement of four or six spirals of highly tensile steel wire
- DIN EN 1829-2

### Applicable Specifications

DIN EN 1829-2

### Recommended Fluids

Water, water-soap emulsion

### Fitting Series

Internal and external skiving



Part Number	Hose I.D.				Hose O.D. mm	Pressure Rating				min. bend radius mm	weight kg
	DN	Inch	Size	mm		max. working pressure		min. burst pressure			
						MPa	psi	MPa	psi		
BPK-4	6	1/4	-4	6.4	17.6	110.0	15900	275.0	39800	100	0.64
BPK-6	10	3/8	-6	9.5	21.8	110.0	15900	275.0	39800	130	1.10
BPK-8	12	1/2	-8	12.7	25.5	110.0	15900	275.0	39800	200	1.40
BPK-12	20	3/4	-12	19.1	35.2	110.0	15900	275.0	39800	250	2.50
BPK-16	25	1	-16	25.4	41.8	80.0	11600	200.0	29000	300	3.00

Replace the hose when any deformation or damage on the hose cover are visible.  
The combination of high temperature and high pressure could reduce the hose life.

Hose layline example









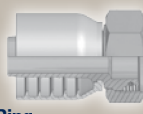

## DIN – Metric

Page Db-1 – Db-4

<p><b>CA</b></p> <p>Db-1</p>  <p><b>Female Metric 24° Light Series with O-Ring Swivel – Straight</b> ISO 12151-2-SWS-L – DKOL</p>	<p><b>CE</b></p> <p>Db-1</p>  <p><b>Female Metric 24° Light Series with O-Ring Swivel – 45° Elbow</b> ISO 12151-2-SWE 45°-L – DKOL 45°</p>	<p><b>CF</b></p> <p>Db-2</p>  <p><b>Female Metric 24° Light Series with O-Ring Swivel – 90° Elbow</b> ISO 12151-2-SWE-L – DKOL 90°</p>	<p><b>D0</b></p> <p>Db-2</p>  <p><b>Male Metric 24° Light Series – Rigid Straight</b> ISO 12151-2-S-L – CEL</p>
<p><b>C9</b></p> <p>Db-3</p>  <p><b>Female Metric 24° – Swivel Heavy Series with O-Ring Straight</b> ISO 12151-2-SWS-S – DKOS</p>	<p><b>OC</b></p> <p>Db-3</p>  <p><b>Female Metric 24° – Swivel Heavy Series with O-Ring 45° Elbow</b> ISO 12151-2 – SWE 45°-S – DKOS 45°</p>	<p><b>1C</b></p> <p>Db-4</p>  <p><b>Female Metric 24° – Swivel Heavy Series with O-Ring 90° Elbow</b> ISO 12151-2-SWE-S – DKOS 90°</p>	<p><b>D2</b></p> <p>Db-4</p>  <p><b>Male Metric 24° – Rigid Heavy Series – Straight</b> ISO 12151-2-S-S – CES</p>

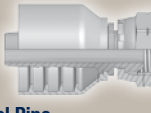

## BSP

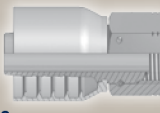
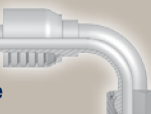
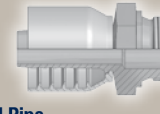
Page Db-5 – Db-7

<p><b>92</b></p> <p>Db-5</p>  <p><b>Female BSP Parallel Pipe Swivel – Straight (60° Cone)</b> BS5200-A – DKR</p>	<p><b>B1</b></p> <p>Db-5</p>  <p><b>Female BSP Parallel Pipe Swivel 45° Elbow (60° Cone)</b> BS 5200-D – DKR 45°</p>	<p><b>B2</b></p> <p>Db-6</p>  <p><b>Female BSP Parallel Pipe Swivel 90° Elbow (60° Cone)</b> BS 5200-B – DKR 90°</p>	<p><b>EA</b></p> <p>Db-6</p>  <p><b>BSP Swivel Female with O-Ring (60° Cone)</b> BS 5200 – ISO 12151-6 – DKOR</p>
<p><b>EC</b></p> <p>Db-7</p>  <p><b>BSP Swivel Female with O-Ring 90° Elbow (60° Cone)</b> BS 5200 – ISO 12151-6 – DKOR 90°</p>	<p><b>D9</b></p> <p>Db-7</p>  <p><b>Male BSP Parallel Pipe Rigid – Straight (60° Cone)</b> BS5200 – AGR</p>		

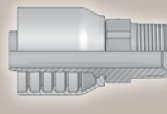
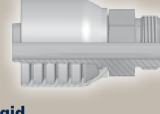
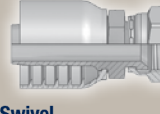

## SAE

Page Db-8 – Db-10

<p><b>01</b></p> <p>Db-8</p>  <p><b>Male NPTF Pipe Rigid – Straight</b> SAE J476A / J516 – AGN</p>	<p><b>03</b></p> <p>Db-8</p>  <p><b>Male JIC 37° – Rigid Straight</b> ISO12151-5-S – AGJ</p>	<p><b>06</b></p> <p>Db-9</p>  <p><b>Female JIC 37° – Swivel Straight</b> ISO12151-5-SWS – DKJ</p>	<p><b>37</b></p> <p>Db-10</p>  <p><b>Female JIC 37° – Swivel 45° Elbow</b> ISO 12151-5-SWE 45° – DKJ 45°</p>
<p><b>39/3W</b></p> <p>Db-10</p>  <p><b>Female JIC 37° SAE 45° – Dual Flare Swivel Female 90° Elbow</b> ISO 12151-5-SWES – DKJ 90°</p>			



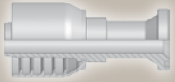
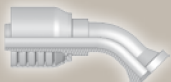
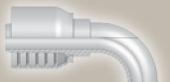
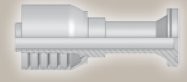
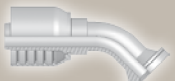

## Flange

Page Db-11 – Db-14

<p><b>15</b> Db-11 <b>ISO 6162-1 Flange Straight</b> ISO 12151-3-S-L – SFL (21.0 MPa/ 3000 psi)</p> 	<p><b>17</b> Db-11 <b>ISO 6162-1 Flange 45° Elbow</b> ISO 12151-3 – E45 – L – SFL 45° (21.0 MPa/ 3000 psi)</p> 	<p><b>19</b> Db-12 <b>ISO 6162-1 Flange 90° Elbow</b> ISO 12151-3 – E – L – SFL 90° (21.0 MPa/ 3000 psi)</p> 	<p><b>6A</b> Db-12 <b>ISO 6162-2 Flange Straight</b> ISO 12151-3-S-S – SFS (42.0 MPa/ 6000 psi)</p> 
<p><b>6F</b> Db-13 <b>ISO 6162-2 Flange 45° Elbow – Heavy Series</b> ISO 12151-3 – E45-S – SFS 45° (42.0 MPa/ 6000 psi)</p> 	<p><b>6N</b> Db-13 <b>ISO 6162-2 Flange 90° Elbow</b> ISO 12151-3 – E-S – SFS 90° (42.0 MPa/ 6000 psi)</p> 	<p><b>PY</b> Db-14 <b>Flange – 24° Male French Gas Straight</b></p> 	

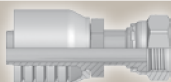
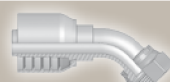
## ORFS

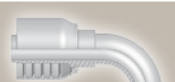
Page Db-15 – Db-17

<p><b>JC</b> Db-15 <b>Female ORFS Swivel – Straight Short</b> ISO 12151-1 – SWSA SAE J516 – ORFS</p> 	<p><b>JS</b> Db-15 <b>ORFS Swivel Female (Long)</b> ISO 12151-1-SWSB SAE J516 – ORFS</p> 	<p><b>J7</b> Db-16 <b>Female ORFS – Swivel 45° Elbow</b> ISO 12151-1 – SWE 45° SAE J516 – ORFS 45°</p> 	<p><b>J9</b> Db-16 <b>Female ORFS – Swivel 90° Elbow – Short Drop</b> ISO 12151-1 – SWES SAE J516 – ORFS 90°</p> 
<p><b>J1</b> Db-17 <b>Female ORFS – Swivel 90° Elbow – Long Drop</b> ISO 12151-1 – SWEL SAE J 516 – ORFS 90° L</p> 	<p><b>JM</b> Db-17 <b>ORFS Male</b> ISO 12151-1-S – SAE J516</p> 		

## JIS



Page Db-18

**MU**  
Db-18  
**Female Metric – Swivel  
Straight (30° Flare)**  
JIS B8363 – MU





## French Standard

Page Db-19

<p><b>FG</b> Db-19 <b>Male French Gas Series Rigid – Straight (24° Cone)</b></p> 	<p><b>F4</b> Db-19 <b>Female French Gas Series Swivel – Straight (Ball Nose)</b></p> 
---	--

## Others

Page Db-20

<p><b>XU</b> Db-20 <b>Female Metric – Swivel Straight (30° Flare)</b> JIS B8363</p> 	<p><b>XY</b> Db-20 <b>Female Metric – Swivel 90° Elbow (30° Flare)</b> JIS B8363</p> 
---	--



**CA** **Female Metric 24°  
Light Series with O-Ring  
Swivel – Straight**

ISO 12151-2-SWS-L – DKOL

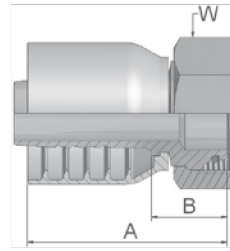

Part Number	Hose I.D.				Thread metric	Tube O.D. mm	A mm	B mm	W mm
	DN	Inch	Size	mm					
1CA70-10-6	10	3/8	-6	9.5	M16x1.5	10	53	24	19
1CA70-12-6	10	3/8	-6	9.5	M18x1.5	12	53	24	22
1CA70-15-8	12	1/2	-8	12.7	M22x1.5	15	62	27	27
1CA70-18-8	12	1/2	-8	12.7	M26x1.5	18	57	22	32
1CA70-15-10	16	5/8	-10	15.9	M22x1.5	15	66	27	27
1CA70-18-10	16	5/8	-10	15.9	M26x1.5	18	62	25	32
1CA70-22-10	16	5/8	-10	15.9	M30x2	22	64	24	36
1CA70-18-12	19	3/4	-12	19.1	M26x1.5	18	65	26	32
1CA70-22-12	19	3/4	-12	19.1	M30x2	22	63	24	36
1CA70-28-12	19	3/4	-12	19.1	M36x2	28	66	26	41
1CA70-28-16	25	1	-16	25.4	M36x2	28	78	33	41
1CA70-35-16	25	1	-16	25.4	M45x2	35	76	31	50

Fittings with standard O-ring seals can be used for temperatures from -40 °C up to +105 °C.

O-rings see section Eb. Special O-rings are available on request.

Attention: Hose assembly pressure is reduced; see page Ab-8

**CE** **Female Metric 24°  
Light Series with O-Ring  
Swivel – 45° Elbow**

ISO 12151-2-SWE 45°-L – DKOL 45°

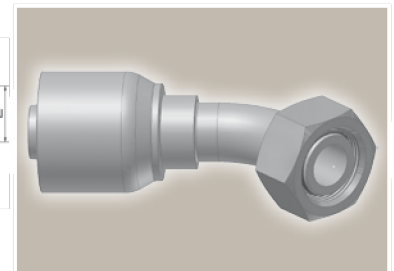
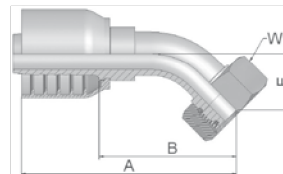

Part Number	Hose I.D.				Thread metric	Tube O.D. mm	A mm	B mm	E mm	W mm
	DN	Inch	Size	mm						
1CE70-12-6	10	3/8	-6	9.5	M18x1.5	12	69	40	20	22
1CE70-15-8	12	1/2	-8	12.7	M22x1.5	15	85	50	24	27
1CE70-18-10	16	5/8	-10	15.9	M26x1.5	18	89	49	23	32
1CE70-22-12	19	3/4	-12	19.1	M30x2	22	98	58	26	36
1CE70-28-16	25	1	-16	25.4	M36x2	28	127	80	34	41

Fittings with standard O-ring seals can be used for temperatures from -40 °C up to +105 °C.

O-rings see section Eb. Special O-rings are available on request.

Attention: Hose assembly pressure is reduced; see page Ab-8

Approved **fitting series** for hose types:

**70** 371LT 372 372RH 372TC 701 701 TC F42-8

**CF** **Female Metric 24°  
Light Series with O-Ring  
Swivel – 90° Elbow**  
ISO 12151-2-SWE-L – DKOL 90°

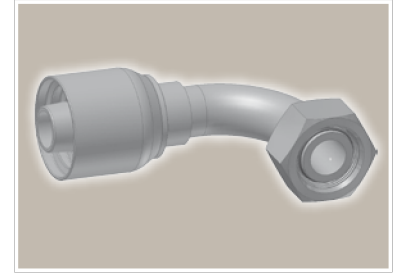
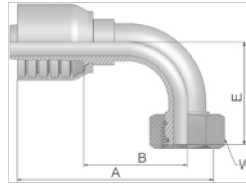

Part Number	Hose I.D.				Thread metric	Tube O.D. mm	A mm	B mm	E mm	W mm
	DN	Inch	Size	mm						
1CF70-10-6	10	3/8	-6	9.5	M16x1.5	10	67	38	38	19
1CF70-12-6	10	3/8	-6	9.5	M18x1.5	12	67	38	37	22
1CF70-15-8	12	1/2	-8	12.7	M22x1.5	15	74	39	45	27
1CF70-18-8	12	1/2	-8	12.7	M26x1.5	18	71	36	40	32
1CF70-15-10	16	5/8	-10	15.9	M22x1.5	15	79	42	50	27
1CF70-18-10	16	5/8	-10	15.9	M26x1.5	18	79	42	49	32
1CF70-18-12	19	3/4	-12	19.1	M26x1.5	18	89	49	56	32
1CF70-22-12	19	3/4	-12	19.1	M30x2	22	89	49	55	36
1CF70-28-16	25	1	-16	25.4	M36x2	28	114	68	78	41
1CF70-35-16	25	1	-16	25.4	M45x2	35	115	68	69	50

Fittings with standard O-ring seals can be used for temperatures from -40 °C up to +105 °C.  
O-rings see section Eb. Special O-rings are available on request.

**DO** **Male Metric 24°  
Light Series – Rigid  
Straight**  
ISO 12151-2-S-L – CEL

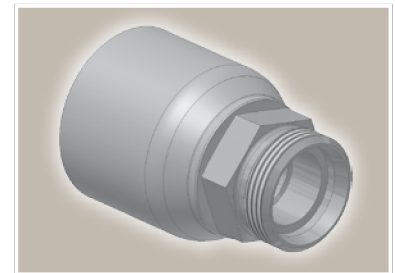
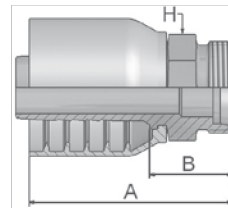

Part Number	Hose I.D.				Thread metric	Tube O.D. mm	A mm	B mm	H mm
	DN	Inch	Size	mm					
1D070-15-8	12	1/2	-8	12.7	M22x1.5	15	60	26	22
1D070-18-10	16	5/8	-10	15.9	M26x1.5	18	65	28	27
1D070-22-12	19	3/4	-12	19.1	M30x2	22	69	30	30
1D070-28-16	25	1	-16	25.4	M36x2	28	79	32	36

Attention: Hose assembly pressure is reduced; see page Ab-8

Approved **fitting series** for hose types:

**70** 371LT 372 372RH 372TC 701 701 TC F42-8

## C9 Female Metric 24° – Swivel Heavy Series with O-Ring Straight

ISO 12151-2-SWS-S – DKOS

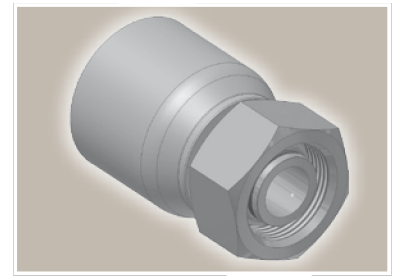
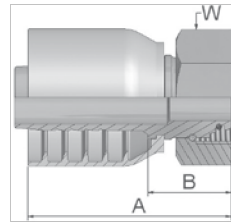

Part Number	Hose I.D.				Thread metric	Tube O.D. mm	A mm	B mm	W mm
	DN	Inch	Size	mm					
1C970-8-6	10	3/8	-6	9.5	M16x1.5	8	53	24	19
1C970-12-6	10	3/8	-6	9.5	M20x1.5	12	52	22	24
1C970-14-6	10	3/8	-6	9.5	M22x1.5	14	53	24	27
1C970-12-8	12	1/2	-8	12.7	M20x1.5	12	60	25	24
1C970-16-8	12	1/2	-8	12.7	M24x1.5	16	59	24	30
1C970-20-8	12	1/2	-8	12.7	M30x2	20	59	24	36
1C970-16-10	16	5/8	-10	15.9	M24x1.5	16	66	27	30
1C970-20-10	16	5/8	-10	15.9	M30x2	20	64	27	36
1C970-25-10	16	5/8	-10	15.9	M36x2	25	65	29	46
1C970-20-12	19	3/4	-12	19.1	M30x2	20	66	27	36
1C970-25-12	19	3/4	-12	19.1	M36x2	25	68	28	46
1C970-25-16	25	1	-16	25.4	M36x2	25	78	33	46
1C970-30-16	25	1	-16	25.4	M42x2	30	80	33	50

Fittings with standard O-ring seals can be used for temperatures from -40 °C up to +105 °C.  
O-rings see section Eb. Special O-rings are available on request.

## OC Female Metric 24° – Swivel Heavy Series with O-Ring 45° Elbow

ISO 12151-2 – SWE 45°-S – DKOS 45°

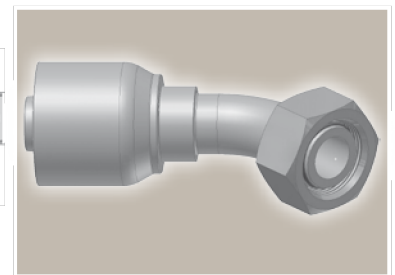
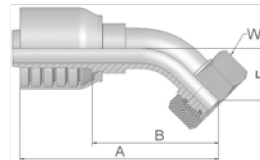

Part Number	Hose I.D.				Thread metric	Tube O.D. mm	A mm	B mm	E mm	W mm
	DN	Inch	Size	mm						
10C70-12-6	10	3/8	-6	9.5	M20x1.5	12	69	40	20	24
10C70-14-6	10	3/8	-6	9.5	M22x1.5	14	76	46	20	27
10C70-16-8	12	1/2	-8	12.7	M24x1.5	16	83	48	24	30
10C70-16-10	16	5/8	-10	15.9	M24x1.5	16	88	49	22	30
10C70-20-10	16	5/8	-10	15.9	M30x2	20	91	52	25	36
10C70-25-10	16	5/8	-10	15.9	M36x2	25	92	56	27	46
10C70-20-12	19	3/4	-12	19.1	M30x2	20	99	60	28	36
10C70-25-12	19	3/4	-12	19.1	M36x2	25	100	61	29	46
10C70-25-16	25	1	-16	25.4	M36x2	25	123	76	33	46
10C70-30-16	25	1	-16	25.4	M42x2	30	126	79	36	50

Fittings with standard O-ring seals can be used for temperatures from -40 °C up to +105 °C.  
O-rings see section Eb. Special O-rings are available on request.

Approved **fitting series** for hose types:

70 371LT 372 372RH 372TC 701 701 TC F42-8

# 1C Female Metric 24° – Swivel Heavy Series with O-Ring 90° Elbow

ISO 12151-2-SWE-S – DKOS 90°

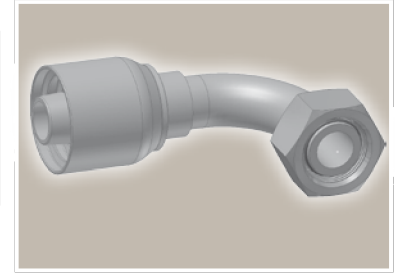
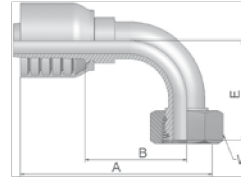

Part Number	Hose I.D.				Thread metric	Tube O.D. mm	A mm	B mm	E mm	W mm
	DN	Inch	Size	mm						
11C70-8-6	10	3/8	-6	9.5	M16x1.5	8	67	38	37	19
11C70-12-6	10	3/8	-6	9.5	M20x1.5	12	67	38	37	24
11C70-14-6	10	3/8	-6	9.5	M22x1.5	14	64	35	37	27
11C70-16-8	12	1/2	-8	12.7	M24x1.5	16	72	37	45	30
11C70-20-8	12	1/2	-8	12.7	M30x2	20	75	40	46	36
11C70-16-10	16	5/8	-10	15.9	M24x1.5	16	79	40	45	30
11C70-20-10	16	5/8	-10	15.9	M30x2	20	79	40	48	36
11C70-25-10	16	5/8	-10	15.9	M36x2	25	85	46	52	46
11C70-20-12	19	3/4	-12	19.1	M30x2	20	89	50	58	36
11C70-25-12	19	3/4	-12	19.1	M36x2	25	89	49	59	46
11C70-30-12	19	3/4	-12	19.1	M42x2	30	89	50	60	50
11C70-25-16	25	1	-16	25.4	M36x2	25	109	64	69	46
11C70-30-16	25	1	-16	25.4	M42x2	30	115	68	76	50

Fittings with standard O-ring seals can be used for temperatures from -40 °C up to +105 °C.  
O-rings see section Eb. Special O-rings are available on request.

# D2 Male Metric 24° – Rigid Heavy Series – Straight

ISO 12151-2-S-S – CES

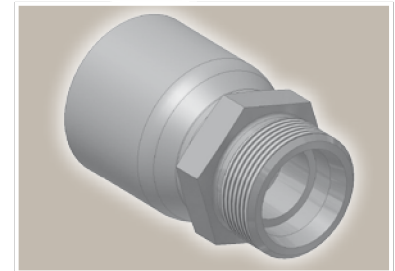
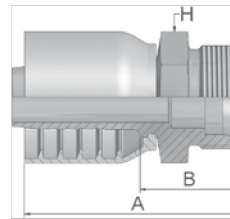

Part Number	Hose I.D.				Thread metric	Tube O.D. mm	A mm	B mm	H mm
	DN	Inch	Size	mm					
1D270-12-6	10	3/8	-6	9.5	M20x1.5	12	53	24	22
1D270-14-6	10	3/8	-6	9.5	M22x1.5	14	55	25	22
1D270-16-8	12	1/2	-8	12.7	M24x1.5	16	62	28	24
1D270-20-8	12	1/2	-8	12.7	M30x2	20	67	32	30
1D270-20-10	16	5/8	-10	15.9	M30x2	20	75	32	30
1D270-20-12	19	3/4	-12	19.1	M30x2	20	72	33	30
1D270-25-12	19	3/4	-12	19.1	M36x2	25	74	35	36
1D270-25-16	25	1	-16	25.4	M36x2	25	84	37	36
1D270-30-16	25	1	-16	25.4	M42x2	30	85	40	46

Approved **fitting series** for hose types:

**70** 371LT 372 372RH 372TC 701 701 TC F42-8



## 92 Female BSP Parallel Pipe Swivel – Straight (60° Cone)

BS5200-A – DKR

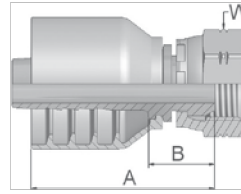

Part Number	Hose I.D.				Thread BSP	A mm	B mm	W mm
	DN	Inch	Size	mm				
19270-6-6	10	3/8	-6	9.5	3/8x19	49	20	22
19270-8-6	10	3/8	-6	9.5	1/2x14	51	22	27
19270-8-8	12	1/2	-8	12.7	1/2x14	57	22	27
19270-10-8	12	1/2	-8	12.7	5/8x14	55	20	30
19270-10-10	16	5/8	-10	15.9	5/8x14	57	21	30
19270-12-10	16	5/8	-10	15.9	3/4x14	61	22	32
19270-12-12	19	3/4	-12	19.1	3/4x14	61	22	32
19270-16-12	19	3/4	-12	19.1	1x11	63	24	41
19270-16-16	25	1	-16	25.4	1x11	72	25	41

## B1 Female BSP Parallel Pipe Swivel 45° Elbow (60° Cone)

BS 5200-D – DKR 45°

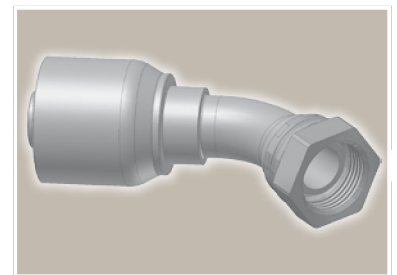
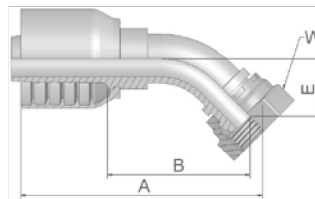

Part Number	Hose I.D.				Thread BSP	A mm	B mm	E mm	W mm
	DN	Inch	Size	mm					
1B170-4-6	10	3/8	-6	9.5	1/4x19	68	39	19	19
1B170-6-6	10	3/8	-6	9.5	3/8x19	67	37	17	22
1B170-8-6	10	3/8	-6	9.5	1/2x14	68	39	19	27
1B170-8-8	12	1/2	-8	12.7	1/2x14	79	45	20	27
1B170-10-8	12	1/2	-8	12.7	5/8x14	78	43	19	30
1B170-10-10	16	5/8	-10	15.9	5/8x14	89	50	23	30
1B170-12-10	16	5/8	-10	15.9	3/4x14	88	49	22	32
1B170-12-12	19	3/4	-12	19.1	3/4x14	96	57	25	32
1B170-16-12	19	3/4	-12	19.1	1x11	95	56	24	41
1B170-16-16	25	1	-16	25.4	1x11	121	77	33	41

Approved **fitting series** for hose types:

70 371LT 372 372RH 372TC 701 701 TC F42-8

## B2 Female BSP Parallel Pipe Swivel 90° Elbow (60° Cone)

BS 5200-B – DKR 90°

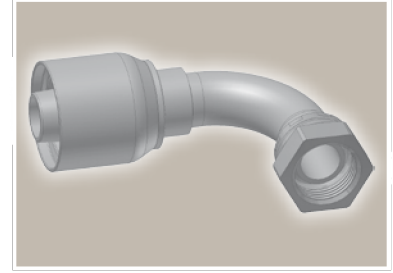
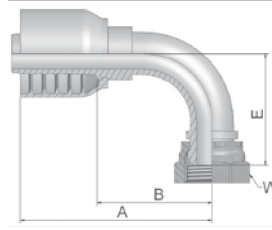

Part Number	Hose I.D.				Thread BSP	A mm	B mm	E mm	W mm
	DN	Inch	Size	mm					
1B270-6-6	10	3/8	-6	9.5	3/8x19	66	37	33	22
1B270-8-6	10	3/8	-6	9.5	1/2x14	66	37	35	27
1B270-8-8	12	1/2	-8	12.7	1/2x14	70	35	39	27
1B270-10-8	12	1/2	-8	12.7	5/8x14	74	39	38	30
1B270-10-10	16	5/8	-10	15.9	5/8x14	81	41	46	30
1B270-12-10	16	5/8	-10	15.9	3/4x14	92	52	59	32
1B270-16-10	16	5/8	-10	15.9	1x11	86	46	44	41
1B270-12-12	19	3/4	-12	19.1	3/4x14	89	50	53	32
1B270-16-12	19	3/4	-12	19.1	1x11	89	49	51	41
1B270-16-16	25	1	-16	25.4	1x11	116	69	69	41

## EA BSP Swivel Female with O-Ring (60° Cone)

BS 5200 – ISO 12151-6 – DKOR

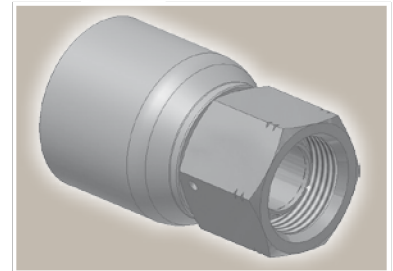
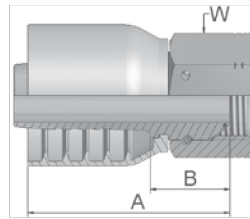

Part Number	Hose I.D.				Thread BSP	A mm	B mm	W mm
	DN	Inch	Size	mm				
1EA70-8-8	12	1/2	-8	12.7	1/2x14	56	21	27
1EA70-12-12	19	3/4	-12	19.1	3/4x14	63	23	32
1EA70-16-16	25	1	-16	25.4	1x11	77	31	41

Fittings with standard O-ring seals can be used for temperatures from -40 °C up to +105 °C.  
O-rings see section Eb. Special O-rings are available on request.

Approved **fitting series** for hose types:

**70** 371LT 372 372RH 372TC 701 701 TC F42-8

## EC BSP Swivel Female with O-Ring 90° Elbow (60° Cone)

BS 5200 – ISO 12151-6 – DKOR 90°

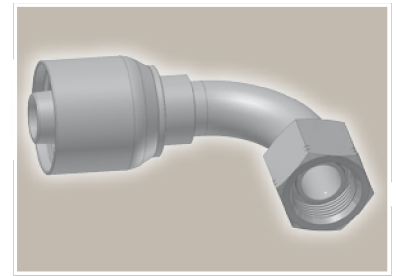
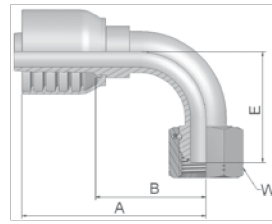

Part Number	Hose I.D.				Thread BSP	A mm	B mm	E mm	W mm
	DN	Inch	Size	mm					
1EC70-8-8	12	1/2	-8	12.7	1/2x14	71	36	40	27
1EC70-12-12	19	3/4	-12	19.1	3/4x14	89	49	55	32
1EC70-16-16	25	1	-16	25.4	1x11	115	68	71	41

Fittings with standard O-ring seals can be used for temperatures from -40 °C up to +105 °C.  
O-rings see section Eb. Special O-rings are available on request.

## D9 Male BSP Parallel Pipe Rigid – Straight (60° Cone)

BS5200 – AGR

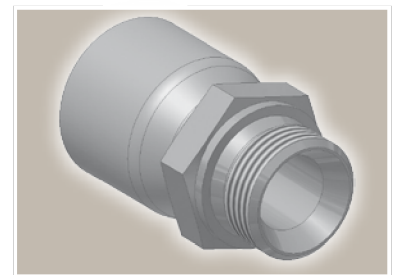
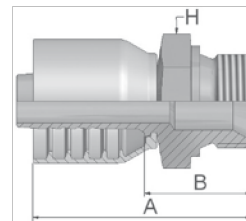

Part Number	Hose I.D.				Thread BSP	A mm	B mm	H mm
	DN	Inch	Size	mm				
1D970-6-6	10	3/8	-6	9.5	3/8x19	57	28	22
1D970-8-6	10	3/8	-6	9.5	1/2x14	60	31	27
1D970-8-8	12	1/2	-8	12.7	1/2x14	62	28	27
1D970-10-8	12	1/2	-8	12.7	5/8x14	70	36	30
1D970-12-8	12	1/2	-8	12.7	3/4x14	69	35	32
1D970-10-10	16	5/8	-10	15.9	5/8x14	75	36	30
1D970-12-10	16	5/8	-10	15.9	3/4x14	72	35	32
1D970-12-12	19	3/4	-12	19.1	3/4x14	72	33	32
1D970-16-12	19	3/4	-12	19.1	1x11	77	38	41
1D970-16-16	25	1	-16	25.4	1x11	85	40	41

Approved **fitting series** for hose types:

70 | 371LT | 372 | 372RH | 372TC | 701 | 701 TC | F42-8

# 01 Male NPTF Pipe Rigid – Straight

SAE J476A / J516 – AGN

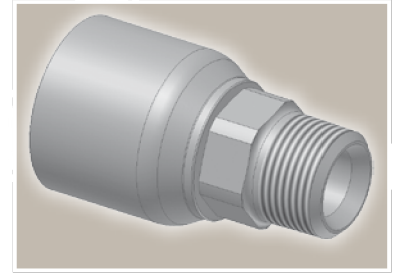
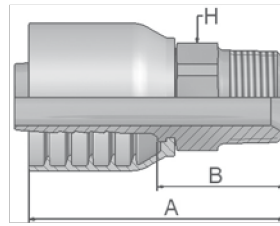

Part Number	Hose I.D.				Thread NPTF	A mm	B mm	H mm
	DN	Inch	Size	mm				
10170-6-6-SM	10	3/8	-6	9.5	3/8x18	60	31	19
10170-12-8-SM	12	1/2	-8	12.7	3/4x14	68	33	27
10170-8-10-SM	16	5/8	-10	15.9	1/2x14	75	38	24
10170-12-10-SM	16	5/8	-10	15.9	3/4x14	71	34	27
10170-12-12-SM	19	3/4	-12	19.1	3/4x14	79	39	27
10170-16-12-SM	19	3/4	-12	19.1	1x11 1/2	79	39	36
10170-16-16-SM	25	1	-16	25.4	1x11 1/2	93	46	36

# 03 Male JIC 37° – Rigid Straight

ISO12151-5-S – AGJ

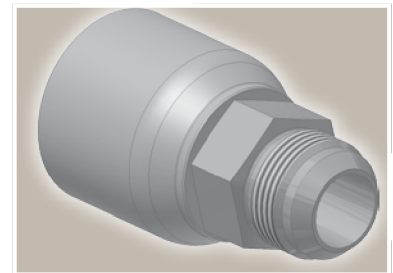
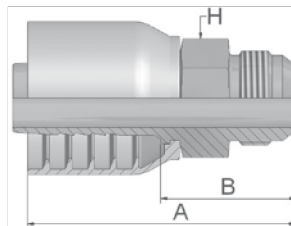

Part Number	Hose I.D.				Thread UNF	A mm	B mm	H mm
	DN	Inch	Size	mm				
10370-6-6-SM	10	3/8	-6	9.5	9/16x18	60	31	19
10370-8-6-SM	10	3/8	-6	9.5	3/4x16	59	29	19
10370-8-8-SM	12	1/2	-8	12.7	3/4x16	68	33	22
10370-10-8-SM	12	1/2	-8	12.7	7/8x14	67	32	24
10370-12-8-SM	12	1/2	-8	12.7	1 1/16x12	71	36	27
10370-10-10-SM	16	5/8	-10	15.9	7/8x14	75	38	24
10370-12-10-SM	16	5/8	-10	15.9	1 1/16x12	75	36	27
10370-12-12-SM	19	3/4	-12	19.1	1 1/16x12	82	42	27
10370-16-12-SM	19	3/4	-12	19.1	1 5/16x12	77	38	36
10370-16-16-SM	25	1	-16	25.4	1 5/16x12	94	47	36

Approved **fitting series** for hose types:

**70** 371LT 372 372RH 372TC 701 701 TC F42-8

06

**Female JIC 37° – Swivel  
Straight**

ISO12151-5-SWS – DKJ

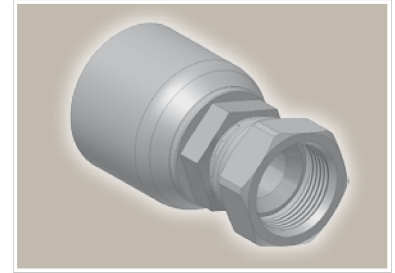
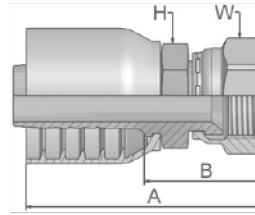

Part Number	Hose I.D.				Thread UNF	A mm	B mm	H mm	W mm
	DN	Inch	Size	mm					
10670-6-6-SM	10	3/8	-6	9.5	9/16x18	58	29	17	19
10670-8-6-SM	10	3/8	-6	9.5	3/4x16	61	32	19	22
10670-8-8-SM*	12	1/2	-8	12.7	3/4x16	67	32	22	22
10670-12-8-SM	12	1/2	-8	12.7	1 1/16x12	71	36	27	32
10670-10-10-SM	16	5/8	-10	15.9	7/8x14	75	35	24	27
10670-12-10-SM	16	5/8	-10	15.9	1 1/16x12	79	39	27	32
10670-12-12-SM	19	3/4	-12	19.1	1 1/16x12	80	41	27	32
10670-14-12-SM	19	3/4	-12	19.1	1 3/16x12	81	42	32	36
10670-16-12-SM	19	3/4	-12	19.1	1 5/16x12	84	45	32	41
10670-12-16-SM	25	1	-16	25.4	1 1/16x12	89	44	36	32
10670-16-16-SM	25	1	-16	25.4	1 5/16x12	94	47	36	41
10670-20-16-SM	25	1	-16	25.4	1 5/8x12	98	52	41	50

\* These fittings contain a dual seat that accepts both JIC (37°) and SAE (45°) male configurations.

Approved **fitting series** for hose types:

70 371LT 372 372RH 372TC 701 701 TC F42-8

### 37 Female JIC 37° – Swivel 45° Elbow

ISO 12151-5-SWE 45° – DKJ 45°

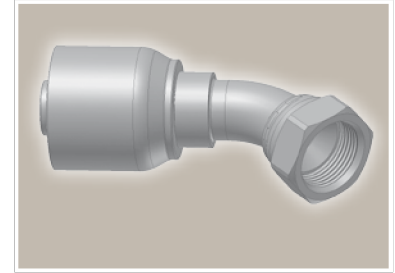
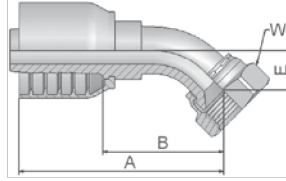

Part Number	Hose I.D.				Thread UNF	A mm	B mm	E mm	W mm
	DN	Inch	Size	mm					
13770-6-6-SM	10	3/8	-6	9.5	9/16x18	61	32	11	19
13770-8-6-SM*	10	3/8	-6	9.5	3/4x16	70	41	14	22
13770-8-8-SM*	12	1/2	-8	12.7	3/4x16	73	38	14	22
13770-10-8-SM*	12	1/2	-8	12.7	7/8x14	78	43	17	27
13770-8-10-SM*	16	5/8	-10	15.9	3/4x16	78	39	15	22
13770-10-10-SM*	16	5/8	-10	15.9	7/8x14	83	42	16	27
13770-12-10-SM	16	5/8	-10	15.9	1 1/16x12	88	48	21	32
13770-12-12-SM	19	3/4	-12	19.1	1 1/16x12	91	52	20	32
13770-16-16-SM	25	1	-16	25.4	1 5/16x12	111	66	24	41
13770-20-16-SM	25	1	-16	25.4	1 5/8x12	114	67	26	50

\* These fittings contain a dual seat that accepts both JIC (37°) and SAE (45°) male configurations.

### 39/3W Female JIC 37° SAE 45° – Dual Flare Swivel Female 90° Elbow

ISO 12151-5-SWES – DKJ 90°

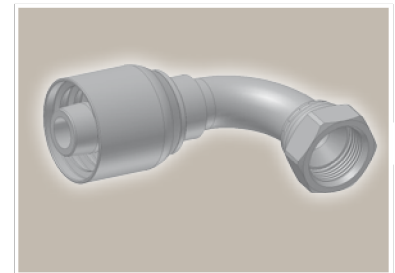
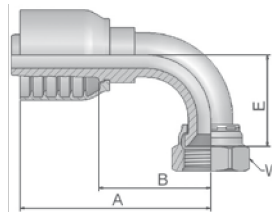

Part Number	Hose I.D.				Thread UNF	A mm	B mm	E mm	W mm
	DN	Inch	Size	mm					
13970-6-6-SM	10	3/8	-6	9.5	9/16x18	57	28	23	19
13W70-8-6-SM	10	3/8	-6	9.5	3/4x16	64	35	29	22
13970-6-8-SM	12	1/2	-8	12.7	9/16x18	64	29	22	19
13970-12-10-SM	16	5/8	-10	15.9	1 1/16x12	87	48	48	32
13970-12-12-SM	19	3/4	-12	19.1	1 1/16x12	89	50	48	32
13970-16-12-SM	19	3/4	-12	19.1	1 5/16x12	89	50	51	41
13970-12-16-SM	25	1	-16	25.4	1 1/16x12	99	54	46	32
13970-16-16-SM	25	1	-16	25.4	1 5/16x12	109	64	56	41
13970-20-16-SM	25	1	-16	25.4	1 5/8x12	111	64	62	50

\* These fittings contain a dual seat that accepts both JIC (37°) and SAE (45°) male configurations.

Approved **fitting series** for hose types:

**70** 371LT 372 372RH 372TC 701 701 TC F42-8

# 15 ISO 6162-1 Flange Straight

ISO 12151-3-S-L – SFL  
(21.0 MPa/ 3000 psi)

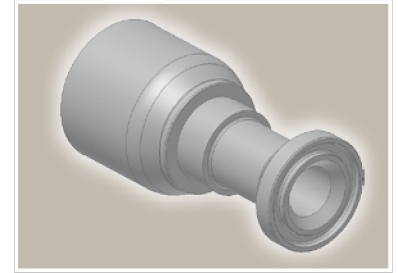
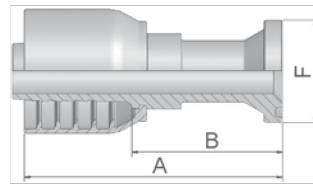

Part Number	Hose I.D.				Flange Inch	A mm	B mm	F mm
	DN	Inch	Size	mm				
11570-8-8	12	1/2	-8	12.7	1/2	89	54	30
11570-10-10	16	5/8	-10	15.9	5/8	116	79	34
11570-12-10	16	5/8	-10	15.9	3/4	69	30	38
11570-12-12	19	3/4	-12	19.1	3/4	98	59	38
11570-16-12	19	3/4	-12	19.1	1	70	31	45
11570-20-12	19	3/4	-12	19.1	1 1/4	75	36	51
11570-12-16	25	1	-16	25.4	3/4	111	66	38
11570-16-16	25	1	-16	25.4	1	108	63	45
11570-20-16	25	1	-16	25.4	1 1/4	82	36	51

SAE flange halves see in section Eb.

Fittings with standard O-ring seals can be used for temperatures from -40 °C up to +105 °C.  
O-rings see section Eb. Special O-rings are available on request.

# 17 ISO 6162-1 Flange 45° Elbow

ISO 12151-3 – E45 – L – SFL 45°  
(21.0 MPa/ 3000 psi)

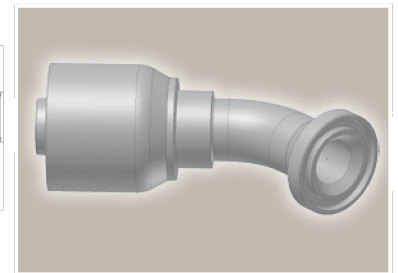
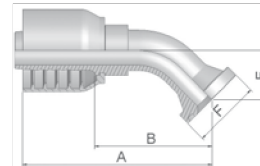

Part Number	Hose I.D.				Flange Inch	A mm	B mm	E mm	F mm
	DN	Inch	Size	mm					
11770-8-8	12	1/2	-8	12.7	1/2	79	44	20	30
11770-10-10	16	5/8	-10	15.9	5/8	104	67	24	34
11770-12-10	16	5/8	-10	15.9	3/4	96	57	26	38
11770-12-12	19	3/4	-12	19.1	3/4	98	58	26	38
11770-16-12	19	3/4	-12	19.1	1	97	57	25	45
11770-16-16	25	1	-16	25.4	1	119	73	27	45
11770-20-16	25	1	-16	25.4	1 1/4	121	76	32	51

SAE flange halves see in section Eb.

Fittings with standard O-ring seals can be used for temperatures from -40 °C up to +105 °C.  
O-rings see section Eb. Special O-rings are available on request.

Approved **fitting series** for hose types:

**70** | 371LT | 372 | 372RH | 372TC | 701 | 701 TC | F42-8

## 19 ISO 6162-1 Flange 90° Elbow

ISO 12151-3 – E- L – SFL 90°  
(21.0 MPa/ 3000 psi)

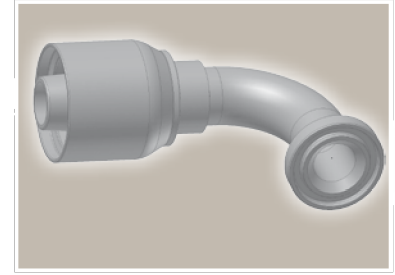
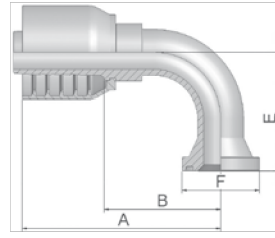

Part Number	Hose I.D.				Flange Inch	A mm	B mm	E mm	F mm
	DN	Inch	Size	mm					
11970-8-8	12	1/2	-8	12.7	1/2	75	40	41	30
11970-12-8	12	1/2	-8	12.7	3/4	77	42	42	38
11970-10-10	16	5/8	-10	15.9	5/8	92	55	55	34
11970-12-10	16	5/8	-10	15.9	3/4	95	65	54	38
11970-12-12	19	3/4	-12	19.1	3/4	89	50	58	38
11970-16-12	19	3/4	-12	19.1	1	90	50	58	45
11970-16-16	25	1	-16	25.4	1	105	55	61	45
11970-20-16	25	1	-16	25.4	1 1/4	113	68	70	51

SAE flange halves see in section Eb.

Fittings with standard O-ring seals can be used for temperatures from -40 °C up to +105 °C.  
O-rings see section Eb. Special O-rings are available on request.

## 6A ISO 6162-2 Flange Straight

ISO 12151-3-S-S – SFS  
(42.0 MPa/ 6000 psi)

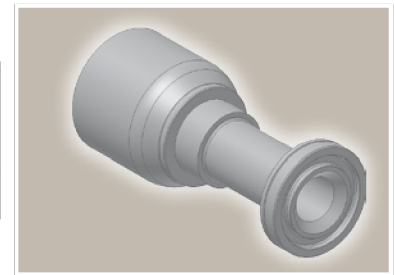
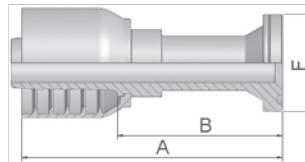

Part Number	Hose I.D.				Flange Inch	A mm	B mm	F mm
	DN	Inch	Size	mm				
16A70-8-8	12	1/2	-8	12.7	1/2	103	68	32
16A70-12-8	12	1/2	-8	12.7	3/4	105	70	41
16A70-8-10	16	5/8	-10	15.9	1/2	107	68	32
16A70-12-10	16	5/8	-10	15.9	3/4	117	78	41
16A70-8-12	19	3/4	-12	19.1	1/2	107	67	32
16A70-12-12	19	3/4	-12	19.1	3/4	105	66	41
16A70-16-12	19	3/4	-12	19.1	1	110	70	48
16A70-12-16	25	1	-16	25.4	3/4	127	82	41
16A70-16-16	25	1	-16	25.4	1	127	82	48
16A70-20-16	25	1	-16	25.4	1 1/4	127	82	54

SAE flange halves see in section Eb.

Fittings with standard O-ring seals can be used for temperatures from -40 °C up to +105 °C.  
O-rings see section Eb. Special O-rings are available on request.

Approved **fitting series** for hose types:

**70** 371LT 372 372RH 372TC 701 701 TC F42-8



## 6F ISO 6162-2 Flange 45° Elbow – Heavy Series

ISO 12151-3 – E45-S – SFS 45°  
(42.0 MPa/ 6000 psi)

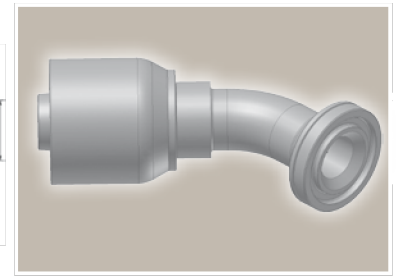
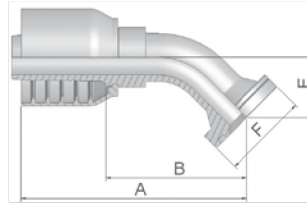

Part Number	Hose I.D.				Flange Inch	A mm	B mm	E mm	F mm
	DN	Inch	Size	mm					
16F70-8-8	12	1/2	-8	12.7	1/2	81	46	19	32
16F70-12-8	12	1/2	-8	12.7	3/4	90	55	26	41
16F70-8-10	16	5/8	-10	15.9	1/2	92	53	26	32
16F70-12-10	16	5/8	-10	15.9	3/4	92	55	26	41
16F70-8-12	19	3/4	-12	19.1	1/2	94	54	26	32
16F70-12-12	19	3/4	-12	19.1	3/4	105	66	26	41
16F70-16-12	19	3/4	-12	19.1	1	101	62	26	48
16F70-12-16	25	1	-16	25.4	3/4	118	73	27	41
16F70-16-16	25	1	-16	25.4	1	117	77	27	48
16F70-20-16	25	1	-16	25.4	1 1/4	117	70	31	54

SAE flange halves see in section Eb.

Fittings with standard O-ring seals can be used for temperatures from -40 °C up to +105 °C.

O-rings see section Eb. Special O-rings are available on request.

## 6N ISO 6162-2 Flange 90° Elbow

ISO 12151-3 – E-S – SFS 90°  
(42.0 MPa/ 6000 psi)

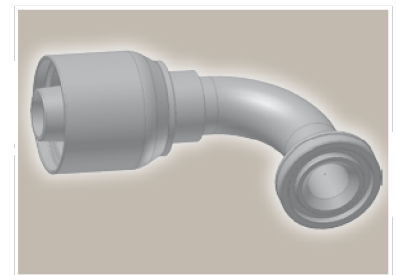
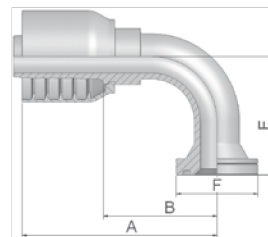

Part Number	Hose I.D.				Flange Inch	A mm	B mm	E mm	F mm
	DN	Inch	Size	mm					
16N70-8-8	12	1/2	-8	12.7	1/2	74	39	41	32
16N70-12-8	12	1/2	-8	12.7	3/4	79	44	45	41
16N70-8-10	16	5/8	-10	15.9	1/2	95	56	54	32
16N70-12-10	16	5/8	-10	15.9	3/4	92	55	54	41
16N70-16-10	16	5/8	-10	15.9	1	86	46	54	48
16N70-8-12	19	3/4	-12	19.1	1/2	81	42	54	32
16N70-12-12	19	3/4	-12	19.1	3/4	98	58	54	41
16N70-16-12	19	3/4	-12	19.1	1	92	53	53	48
16N70-12-16	25	1	-16	25.4	3/4	113	66	57	41
16N70-16-16	25	1	-16	25.4	1	111	64	70	48
16N70-20-16	25	1	-16	25.4	1 1/4	115	68	68	54

SAE flange halves see in section Eb.

Fittings with standard O-ring seals can be used for temperatures from -40 °C up to +105 °C.

O-rings see section Eb. Special O-rings are available on request.

Approved **fitting series** for hose types:

**70** 371LT 372 372RH 372TC 701 701 TC F42-8

**PY**      **Flange – 24° Male  
French Gas  
Straight**

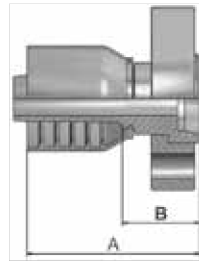

Part Number	 Hose I.D.				A mm	B mm
	DN	Inch	Size	mm		
1PY70-10-10	16	5/8	-10	15.9	63	24
1PY70-12-12	19	3/4	-12	19.1	69	30
1PY70-16-16	25	1	-16	25.4	87	41

Approved **fitting series** for hose types:

**70** 371LT 372 372RH 372TC 701 701 TC F42-8

# JC

## Female ORFS Swivel – Straight Short

ISO 12151-1 – SWSA  
SAE J516 – ORFS

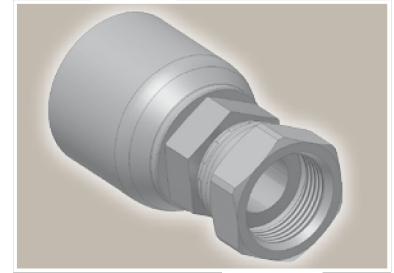
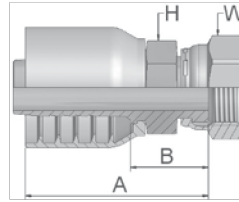

Part Number	Hose I.D.				Thread UNF	A mm	B mm	H mm	W mm
	DN	Inch	Size	mm					
1JC70-6-6-SM	10	3/8	-6	9.5	11/16x16	49	20	19	22
1JC70-8-6-SM	10	3/8	-6	9.5	13/16x16	51	22	19	24
1JC70-8-8-SM	12	1/2	-8	12.7	13/16x16	56	24	13/16	15/16
1JC70-10-8-SM	12	1/2	-8	12.7	1x14	58	24	24	30
1JC70-12-8-SM	12	1/2	-8	12.7	1 3/16x12	63	28	32	36
1JC70-8-10-SM	16	5/8	-10	15.9	13/16x16	59	22	22	24
1JC70-10-10-SM	16	5/8	-10	15.9	1x14	64	24	24	30
1JC70-12-10-SM	16	5/8	-10	15.9	1 3/16x12	68	29	32	36
1JC70-8-12-SM	19	3/4	-12	19.1	13/16x16	61	22	27	24
1JC70-12-12-SM	19	3/4	-12	19.1	1 3/16x12	68	29	32	36
1JC70-16-12-SM	19	3/4	-12	19.1	1 7/16x12	72	33	36	41
1JC70-12-16-SM	25	1	-16	25.4	13/16x12	76	31	36	36
1JC70-16-16-SM	25	1	-16	25.4	1 7/16x12	80	35	36	41
1JC70-20-16-SM	25	1	-16	25.4	1 11/16x12	79	34	41	50

# JS

## ORFS Swivel Female (Long)

ISO 12151-1-SWSB  
SAE J516 – ORFS

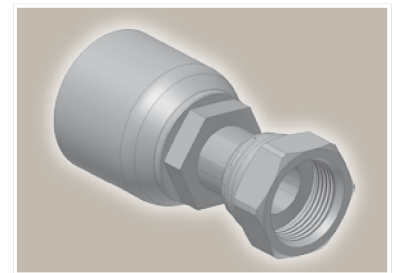
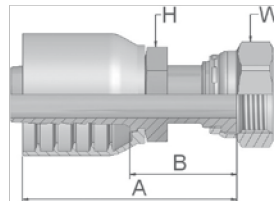

Part Number	Hose I.D.				Thread UNF	A mm	B mm	H mm	W mm
	DN	Inch	Size	mm					
1JS70-6-6-SM	10	3/8	-6	9.5	11/16x16	58	29	17	22
1JS70-8-6-SM	10	3/8	-6	9.5	13/16x16	64	35	19	24
1JS70-8-8-SM	12	1/2	-8	12.7	13/16x16	67	33	22	24
1JS70-10-8-SM	12	1/2	-8	12.7	1x14	73.5	38.5	24	30
1JS70-10-10-SM	16	5/8	-10	15.9	1x14	79	39	24	30
1JS70-12-12-SM	19	3/4	-12	19.1	1 3/16x12	84	45	30	36
1JS70-16-12-SM	19	3/4	-12	19.1	1 7/16x12	86	47	36	41
1JS70-16-16-SM	25	1	-16	25.4	1 7/16x12	98	53	36	41
1JS70-20-16-SM	25	1	-16	25.4	1 11/16x12	94	47	41	50

Approved fitting series for hose types:

70 371LT 372 372RH 372TC 701 701 TC F42-8

## J7 Female ORFS – Swivel 45° Elbow

ISO 12151-1 – SWE 45°  
SAE J516 – ORFS 45°

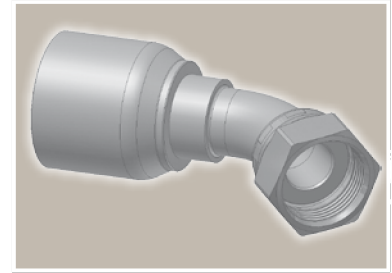
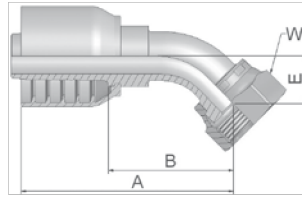

Part Number	Hose I.D.				Thread UNF	A mm	B mm	E mm	W mm
	DN	Inch	Size	mm					
1J770-6-6-SM	10	3/8	-6	9.5	11/16x16	62	33	11	22
1J770-8-6-SM	10	3/8	-6	9.5	13/16x16	64	35	15	24
1J770-6-8-SM	12	1/2	-8	12.7	11/16x16	68	33	11	22
1J770-8-8-SM	12	1/2	-8	12.7	13/16x16	72	37	15	24
1J770-10-8-SM	12	1/2	-8	12.7	1x14	80	46	17	30
1J770-10-10-SM	16	5/8	-10	15.9	1x14	83	44	16	30
1J770-12-10-SM	16	5/8	-10	15.9	1 3/16x12	90	53	21	36
1J770-12-12-SM	19	3/4	-12	19.1	1 3/16x12	92	53	21	36
1J770-16-12-SM	19	3/4	-12	19.1	1 7/16x12	95	56	24	41
1J770-16-16-SM	25	1	-16	25.4	1 7/16x12	113	66	24	41

## J9 Female ORFS – Swivel 90° Elbow – Short Drop

ISO 12151-1 – SWES  
SAE J516 – ORFS 90°

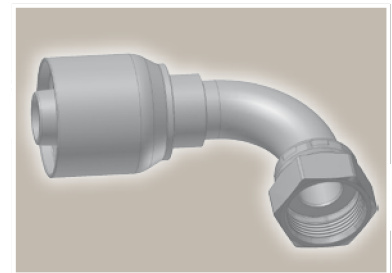
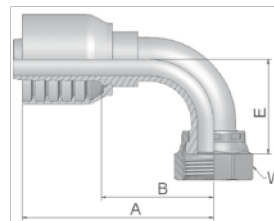

Part Number	Hose I.D.				Thread UNF	A mm	B mm	E mm	W mm
	DN	Inch	Size	mm					
1J970-6-6-SM	10	3/8	-6	9.5	11/16x16	58	29	23	22
1J970-8-6-SM	10	3/8	-6	9.5	13/16x16	58	29	29	24
1J970-8-8-SM	12	1/2	-8	12.7	13/16x16	70	35	29	24
1J970-10-8-SM	12	1/2	-8	12.7	1x14	73	38	32	30
1J970-12-8-SM	12	1/2	-8	12.7	1 3/16x12	76	41	48	36
1J970-10-10-SM	16	5/8	-10	15.9	1x14	78	39	33	30
1J970-12-10-SM	16	5/8	-10	15.9	1 3/16x12	86	50	48	36
1J970-12-12-SM	19	3/4	-12	19.1	1 3/16x12	89	49	48	36
1J970-16-12-SM	19	3/4	-12	19.1	1 7/16x12	89	49	56	41
1J970-16-16-SM	25	1	-16	25.4	1 7/16x12	111	64	56	41
1J970-20-16-SM	25	1	-16	25.4	1 11/16x12	111	64	64	50

Approved **fitting series** for hose types:

**70** 371LT 372 372RH 372TC 701 701 TC F42-8

# J1 Female ORFS – Swivel 90° Elbow – Long Drop

ISO 12151-1 – SWEL  
SAE J 516 – ORFS 90° L

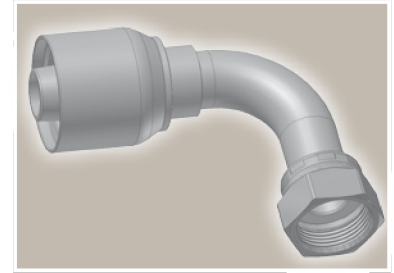
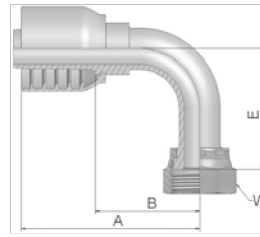

Part Number	Hose I.D.				Thread UNF	A mm	B mm	E mm	W mm
	DN	Inch	Size	mm					
1J170-8-8-SM	12	1/2	-8	12.7	13/16x16	71	36	64	24
1J170-10-8-SM	12	1/2	-8	12.7	1x14	73	38	70	30
1J170-10-10-SM	16	5/8	-10	15.9	1x14	78	39	70	30
1J170-12-10-SM	16	5/8	-10	15.9	1 3/16x12	76	40	96	36
1J170-12-12-SM	19	3/4	-12	19.1	1 3/16x12	89	49	96	36
1J170-16-16-SM	25	1	-16	25.4	1 7/16x12	109	64	114	41

# JM ORFS Male

ISO 12151-1-S – SAE J516

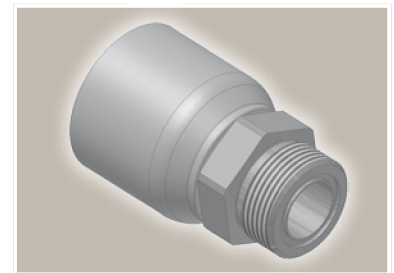
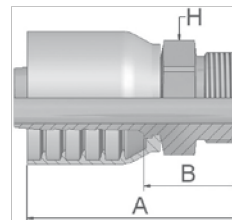

Part Number	Hose I.D.				Thread UNF	A mm	B mm	H mm
	DN	Inch	Size	mm				
1JM70-6-6-SM	10	3/8	-6	9.5	11/16x16	53	24	19
1JM70-8-6-SM	10	3/8	-6	9.5	13/16x16	56	27	22
1JM70-8-8-SM	12	1/2	-8	12.7	13/16x16	62	27	22
1JM70-10-8-SM	12	1/2	-8	12.7	1x14	66	32	27
1JM70-10-10-SM	16	5/8	-10	15.9	1x14	68	32	27
1JM70-12-10-SM	16	5/8	-10	15.9	1 3/16x12	71	34	32
1JM70-12-12-SM	19	3/4	-12	19.1	1 3/16x12	74	34	32
1JM70-16-12-SM	19	3/4	-12	19.1	1 7/16x12	74	35	41
1JM70-16-16-SM	25	1	-16	25.4	1 7/16x12	84	39	41
1JM70-20-16-SM	25	1	-16	25.4	1 11/16x12	82	37	46

JM fittings are supplied without O-ring.  
O-rings see section Eb. Special O-rings are available on request.





Approved **fitting series** for hose types:

**70** 371LT 372 372RH 372TC 701 701 TC F42-8

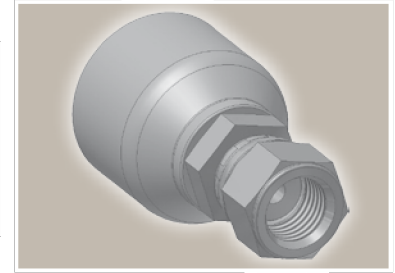
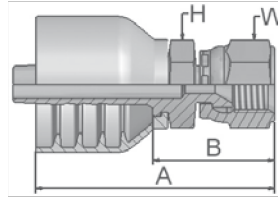
# MU Female Metric – Swivel Straight (30° Flare)

JIS B8363 – MU



Part Number	 Hose I.D.				 Thread	A mm	B mm	 H mm	 W mm
	DN	Inch	Size	mm	metric				
1MU70-6-6	10	3/8	-6	9.5	M18x1.5	62	33	24	24
1MU70-8-8	12	1/2	-8	12.7	M22x1.5	72	37	27	27
1MU70-12-12	19	3/4	-12	19.1	M27x2	81	41	36	36

Approved **fitting series** for hose types:

**70** 371LT 372 372RH 372TC 701 701 TC F42-8

## FG Male French Gas Series Rigid – Straight (24° Cone)

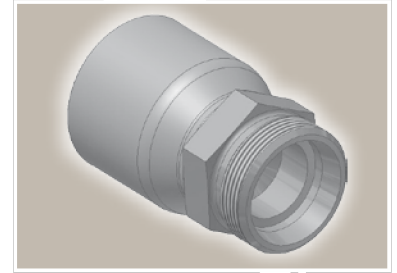
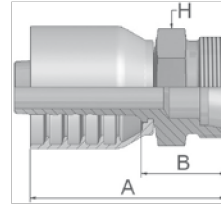

Part Number	Hose I.D.				Thread metric	Tube O.D. mm	A mm	B mm	H mm
	DN	Inch	Size	mm					
1FG70-13-6	10	3/8	-6	9.5	M20x1.5	13.25	46	24	22
1FG70-17-8	12	1/2	-8	12.7	M24x1.5	16.75	62	27	24
1FG70-21-10	16	5/8	-10	15.9	M30x1.5	21.25	70	30	30
1FG70-27-12	19	3/4	-12	19.1	M36x1.5	26.75	70	30	36
1FG70-33-16	25	1	-16	25.4	M45x1.5	33.50	82	36	46

## F4 Female French Gas Series Swivel – Straight (Ball Nose)

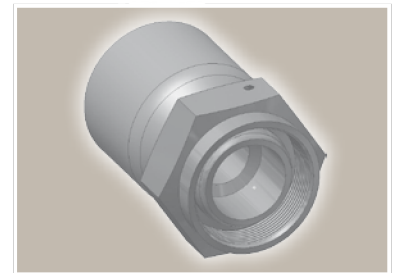
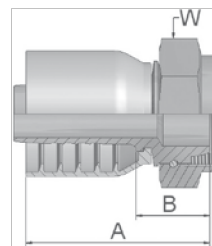

Part Number	Hose I.D.				Thread metric	Tube O.D. mm	A mm	B mm	W mm
	DN	Inch	Size	mm					
1F470-13-6	10	3/8	-6	9.5	M20x1.5	13	52	22	24
1F470-17-8	12	1/2	-8	12.7	M24x1.5	17	60	25	30
1F470-21-10	16	5/8	-10	15.9	M30x1.5	21	62	25	36
1F470-27-12	19	3/4	-12	19.1	M36x1.5	27	70	31	46

Approved **fitting series** for hose types:

70 371LT 372 372RH 372TC 701 701 TC F42-8

## XU Female Metric – Swivel Straight (30° Flare)

JIS B8363

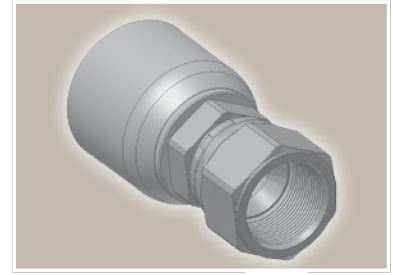
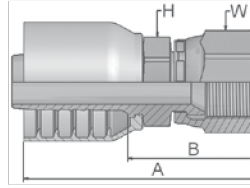

Part Number	Hose I.D.				Thread metric	A mm	B mm	H mm	W mm
	DN	Inch	Size	mm					
1XU70-10-10	16	5/8	-10	15.9	M24x1.5	67	28	30	32
1XU70-12-12	19	3/4	-12	19.1	M30x1.5	68	28	32	36
1XU70-16-16	25	1	-16	25.4	M33x1.5	82	35	36	41

## XY Female Metric – Swivel 90° Elbow (30° Flare)

JIS B8363

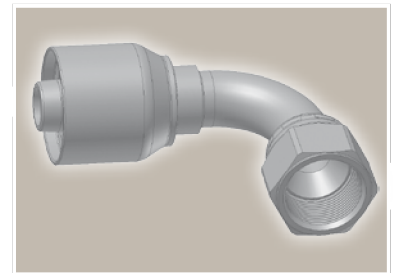
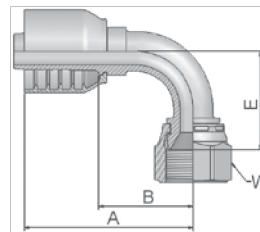

Part Number	Hose I.D.				Thread metric	A mm	B mm	E mm	W mm
	DN	Inch	Size	mm					
1XY70-10-10	16	5/8	-10	15.9	M24x1.5	77	41	41	32
1XY70-12-12	19	3/4	-12	19.1	M24x1.5	89	49	52	36

Approved **fitting series** for hose types:





70 371LT 372 372RH 372TC 701 701 TC F42-8





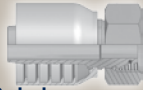

## DIN – Metric

Page Dc-1 – Dc-2

<p><b>C9</b> Dc-1 Female Metric 24° – Swivel Heavy Series with O-Ring Straight ISO 12151-2-SWS-S – DKOS</p> 	<p><b>0C</b> Dc-1 Female Metric 24° – Swivel Heavy Series with O-Ring 45° Elbow ISO 12151-2-SWE 45°-S – DKOS 45°</p> 	<p><b>1C</b> Dc-2 Female Metric 24° – Swivel Heavy Series with O-Ring 90° Elbow ISO 12151-2-SWE-S – DKOS 90°</p> 	<p><b>D2</b> Dc-2 Male Metric 24° – Rigid Heavy Series – Straight ISO 12151-2-S-S – CES</p> 
---	--	---	---

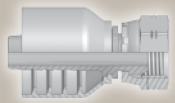

## BSP

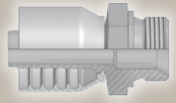
Page Dc-3 – Dc-4

<p><b>92</b> Dc-3 Female BSP Parallel Pipe Swivel – Straight (60° Cone) BS5200-A – DKR</p> 	<p><b>B1</b> Dc-3 Female BSP Parallel Pipe Swivel 45° Elbow (60° Cone) BS 5200-D – DKR 45°</p> 	<p><b>B2</b> Dc-4 Female BSP Parallel Pipe Swivel 90° Elbow (60° Cone) BS 5200-B – DKR 90°</p> 	<p><b>D9</b> Dc-4 Male BSP Parallel Pipe Rigid – Straight (60° Cone) BS5200 – AGR</p> 
--	--	---	---

## SAE

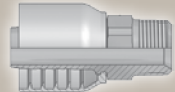
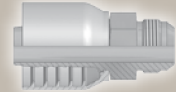
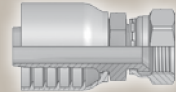
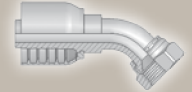

Page Dc-5 – Dc-7

<p><b>01</b> Dc-5 Male NPTF Pipe Rigid – Straight SAE J476A / J516 – AGN</p> 	<p><b>03</b> Dc-5 Male JIC 37° – Rigid Straight ISO12151-5-S – AGJ</p> 	<p><b>06</b> Dc-6 Female JIC 37° – Swivel Straight ISO12151-5-SWS – DKJ</p> 	<p><b>37</b> Dc-6 Female JIC 37° – Swivel 45° Elbow ISO 12151-5-SWE 45° – DKJ 45°</p> 
<p><b>39</b> Dc-7 Female JIC 37° – Swivel 90° Elbow ISO 12151-5-SWES – DKJ 90°</p> 			

**A large range of special hose fittings for the MRO market can be found on page Dc-19**

## Flange

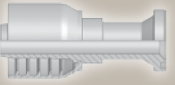
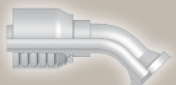
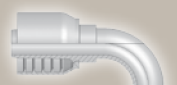
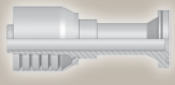
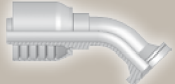
Page Dc-8 – Dc-12

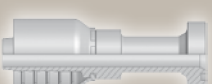
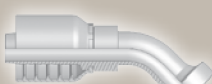
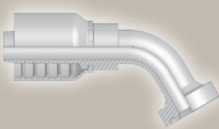
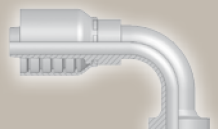
<p><b>15/4A</b> Dc-8 ISO 6162-1 Flange Straight ISO 12151-3-S-L – SFL (35.0 MPa/ 5000 psi)</p> 	<p><b>17/4F</b> Dc-8 ISO 6162-1 Flange 45° Elbow ISO 12151-3 – E45S – L – SFL 45° (35.0 MPa/ 5000 psi)</p> 	<p><b>19/4N</b> Dc-9 ISO 6162-1 Flange 90° Elbow ISO 12151-3-E-L – SFL 90° (35.0 MPa/ 5000 psi)</p> 	<p><b>6A</b> Dc-9 ISO 6162-2 Flange Straight ISO 12151-3-S-S – SFS (42.0 MPa/ 6000 psi)</p> 
<p><b>6F</b> Dc-10 ISO 6162-2 Flange 45° Elbow – Heavy Series ISO 12151-3 – E45-S – SFS 45° (42.0 MPa/ 6000 psi)</p> 	<p><b>6N</b> Dc-10 ISO 6162-2 Flange 90° Elbow ISO 12151-3 – E-S – SFS 90° (42.0 MPa/ 6000 psi)</p> 	<p><b>XA</b> Dc-11 Caterpillar® Flange Straight</p> 	<p><b>XF</b> Dc-11 Caterpillar® Flange 45° Elbow</p> 
<p><b>XG</b> Dc-12 Caterpillar® Flange 60° Elbow</p> 	<p><b>XN</b> Dc-12 Caterpillar® Flange 90° Elbow</p> 		

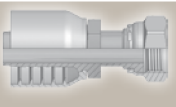

## ORFS

Page Dc-13 – Dc-15

<p><b>JC</b> Dc-13 Female ORFS Swivel – Straight Short ISO 12151-1 – SWSA SAE J516 – ORFS</p> 	<p><b>JS</b> Dc-13 ORFS Swivel Female (Long) ISO 12151-1-SWSB SAE J516 – ORFS</p> 	<p><b>J7</b> Dc-14 Female ORFS – Swivel 45° Elbow ISO 12151-1 – SWE 45° SAE J516 – ORFS 45°</p> 	<p><b>J9</b> Dc-14 Female ORFS – Swivel 90° Elbow – Short Drop ISO 12151-1 – SWES SAE J516 – ORFS 90°</p> 
<p><b>JM</b> Dc-15 ORFS Male ISO 12151-1-S – SAE J516</p> 			

## French Standard

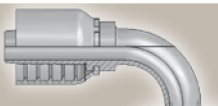
Page Dc-16 – Dc-17

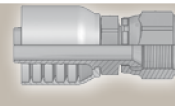
<p><b>FG</b> Dc-16 Male French Gas Series Rigid – Straight (24° Cone)</p> 	<p><b>F2</b> Dc-16 Female French Gas Series Swivel – 90° Elbow</p> 	<p><b>F4</b> Dc-17 Female French Gas Series Swivel – Straight (Ball Nose)</p> 	<p><b>XU</b> Dc-18 Female Metric – Swivel Straight (30° Flare) JIS B8363</p> 
---	--	--	--

## Others

Page Dc-18



## C9 Female Metric 24° – Swivel Heavy Series with O-Ring Straight

ISO 12151-2-SWS-S – DKOS

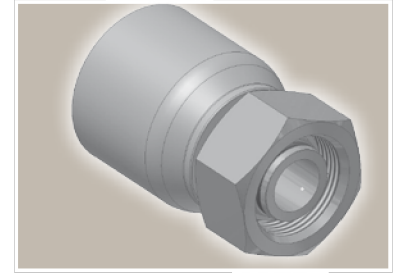
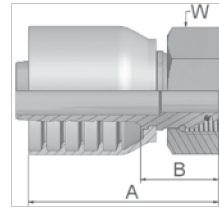

Part Number	Hose I.D.				Thread metric	Tube O.D. mm	A mm	B mm	W mm
	DN	Inch	Size	mm					
1C973-20-12	19	3/4	-12	19.1	M30x2	20	81	33	36
1C973-25-12	19	3/4	-12	19.1	M36x2	25	79	31	46
1C973-25-12SW41	19	3/4	-12	19.1	M36x2	25	79	31	41
1C973-30-12	19	3/4	-12	19.1	M42x2	30	82	34	50
1C973-25-16	25	1	-16	25.4	M36x2	25	87	36	46
1C973-30-16	25	1	-16	25.4	M42x2	30	87	36	50
1C973-25-20	31	1 1/4	-20	31.8	M36x2	25	102	38	46
1C973-30-20	31	1 1/4	-20	31.8	M42x2	30	106	42	50
1C973-38-20	31	1 1/4	-20	31.8	M52x2	38	101	37	60
1C973-38-24	38	1 1/2	-24	38.1	M52x2	38	105	42	60

Fittings with standard O-ring seals can be used for temperatures from -40 °C up to +105 °C.  
O-rings see section Eb. Special O-rings are available on request.

## OC Female Metric 24° – Swivel Heavy Series with O-Ring 45° Elbow

ISO 12151-2 – SWE 45°-S – DKOS 45°

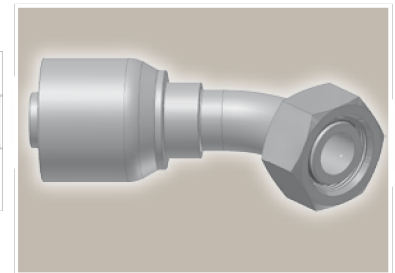
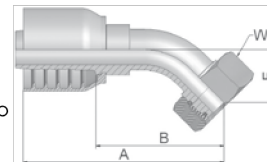

Part Number	Hose I.D.				Thread metric	Tube O.D. mm	A mm	B mm	E mm	W mm
	DN	Inch	Size	mm						
10C73-20-12	19	3/4	-12	19.1	M30x2	20	113	65	30	36
10C73-25-12SW41	19	3/4	-12	19.1	M36x2	25	112	64	29	41
10C73-25-12	19	3/4	-12	19.1	M36x2	25	112	64	29	46
10C73-25-16	25	1	-16	25.4	M36x2	25	128	78	33	46
10C73-30-16	25	1	-16	25.4	M42x2	30	137	128	33	50
10C73-25-20	31	1 1/4	-20	31.8	M36x2	25	150	86	33	46
10C73-30-20	31	1 1/4	-20	31.8	M42x2	30	147	83	34	50
10C73-38-20	31	1 1/4	-20	31.8	M52x2	38	161	97	37	60
10C73-38-24	38	1 1/2	-24	38.1	M52x2	38	182	120	49	60

Fittings with standard O-ring seals can be used for temperatures from -40 °C up to +105 °C.  
O-rings see section Eb. Special O-rings are available on request.

Approved **fitting series** for hose types:

**73** 731 731TC

# 1C Female Metric 24° – Swivel Heavy Series with O-Ring 90° Elbow

ISO 12151-2-SWE-S – DKOS 90°

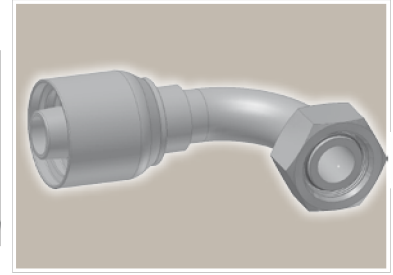
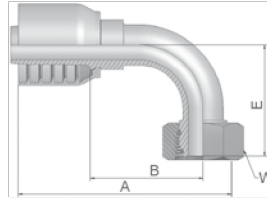

Part Number	Hose I.D.				Thread metric	Tube O.D. mm	A mm	B mm	E mm	W mm
	DN	Inch	Size	mm						
11C73-20-12	19	3/4	-12	19.1	M30x2	20	101	53	60	36
11C73-25-12SW41	19	3/4	-12	19.1	M36x2	25	101	53	59	41
11C73-25-12	19	3/4	-12	19.1	M36x2	25	101	53	59	46
11C73-25-16	25	1	-16	25.4	M36x2	25	117	67	69	46
11C73-30-16	25	1	-16	25.4	M42x2	30	130	118	67	50
11C73-30-20	31	1 1/4	-20	31.8	M42x2	30	137	73	73	50
11C73-38-20	31	1 1/4	-20	31.8	M52x2	38	151	87	78	60
11C73-38-24	38	1 1/2	-24	38.1	M52x2	38	166	103	101	60
11C73-38-32	51	2	-32	50.8	M52x2	38	224	152	166	60

Fittings with standard O-ring seals can be used for temperatures from -40 °C up to +105 °C.  
O-rings see section Eb. Special O-rings are available on request.

# D2 Male Metric 24° – Rigid Heavy Series – Straight

ISO 12151-2-S-S – CES

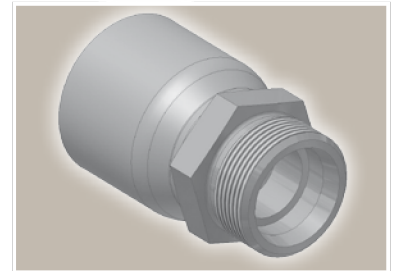
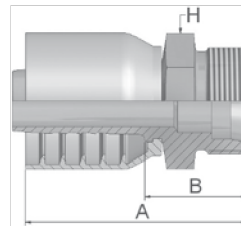

Part Number	Hose I.D.				Thread metric	Tube O.D. mm	A mm	B mm	H mm
	DN	Inch	Size	mm					
1D273-20-12	19	3/4	-12	19.1	M30x2	20	84	35	30
1D273-25-12	19	3/4	-12	19.1	M36x2	25	86	38	36
1D273-30-12	19	3/4	-12	19.1	M42x2	30	90	42	46
1D273-25-16	25	1	-16	25.4	M36x2	25	91	40	36
1D273-30-16	25	1	-16	25.4	M42x2	30	94	42	46
1D273-30-20	31	1 1/4	-20	31.8	M42x2	30	110	46	46
1D273-38-20	31	1 1/4	-20	31.8	M52x2	38	112	46	55

Approved **fitting series** for hose types:

73 731 731TC

## 92 Female BSP Parallel Pipe Swivel – Straight (60° Cone)

BS5200-A – DKR

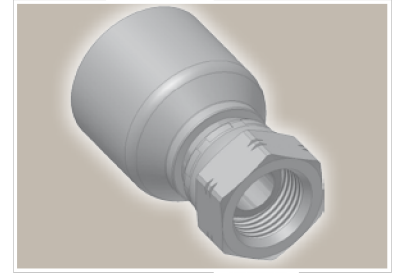
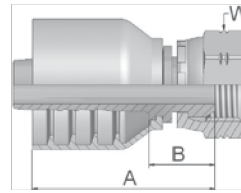

Part Number	Hose I.D.				Thread BSP	A mm	B mm	W mm
	DN	Inch	Size	mm				
19273-12-12	19	3/4	-12	19.1	3/4x14	75	27	32
19273-16-16	25	1	-16	25.4	1x11	89	38	41
19273-20-20	31	1 1/4	-20	31.8	1 1/4x11	101	37	50
19273-24-20	31	1 1/4	-20	31.8	1 1/2x11	101	37	55
19273-24-24	38	1 1/2	-24	38.1	1 1/2x11	100	37	55
19273-32-32	51	2	-32	50.8	2x11	113	38	70

## B1 Female BSP Parallel Pipe Swivel 45° Elbow (60° Cone)

BS 5200-D – DKR 45°

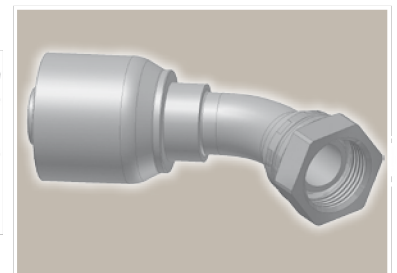
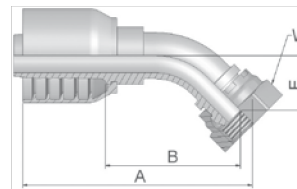

Part Number	Hose I.D.				Thread BSP	A mm	B mm	E mm	W mm
	DN	Inch	Size	mm					
1B173-12-12	19	3/4	-12	19.1	3/4x14	110	62	26	32
1B173-16-16	25	1	-16	25.4	1x11	136	84	36	41
1B173-20-20	31	1 1/4	-20	31.8	1 1/4x11	168	104	43	50
1B173-24-24	38	1 1/2	-24	38.1	1 1/2x11	186	123	52	55
1B173-32-32	51	2	-32	50.8	2x11	249	177	70	70

Approved **fitting series** for hose types:

**73** 731 731TC

## B2 Female BSP Parallel Pipe Swivel 90° Elbow (60° Cone)

BS 5200-B – DKR 90°

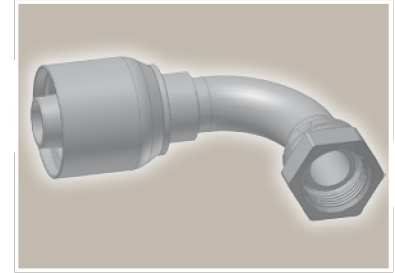
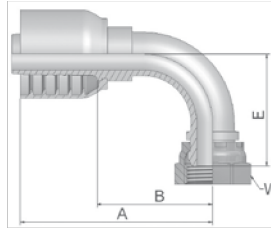

Part Number	Hose I.D.				Thread BSP	A mm	B mm	E mm	W mm
	DN	Inch	Size	mm					
1B273-12-12	19	3/4	-12	19.1	3/4x14	106	58	55	32
1B273-16-16	25	1	-16	25.4	1x11	120	70	74	41
1B273-20-20	31	1 1/4	-20	31.8	1 1/4x11	151	87	80	50
1B273-24-20	31	1 1/4	-20	31.8	1 1/2x11	151	87	80	55
1B273-24-24	38	1 1/2	-24	38.1	1 1/2x11	166	103	103	55
1B273-32-32	51	2	-32	50.8	2x11	229	157	121	70

## D9 Male BSP Parallel Pipe Rigid – Straight (60° Cone)

BS5200 – AGR

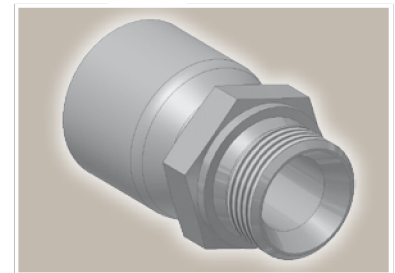
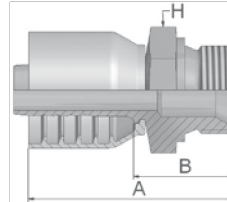

Part Number	Hose I.D.				Thread BSP	A mm	B mm	H mm
	DN	Inch	Size	mm				
1D973-12-12	19	3/4	-12	19.1	3/4x14	87	39	32
1D973-16-16	25	1	-16	25.4	1x11	96	43	41
1D973-20-20	31	1 1/4	-20	31.8	1 1/4x11	113	49	50
1D973-24-24	38	1 1/2	-24	38.1	1 1/2x11	114	51	55
1D973-32-32	51	2	-32	50.8	2x11	129	58	70

Approved **fitting series** for hose types:

73 731 731TC



# 01

## Male NPTF Pipe Rigid – Straight

SAE J476A/ J516 – AGN

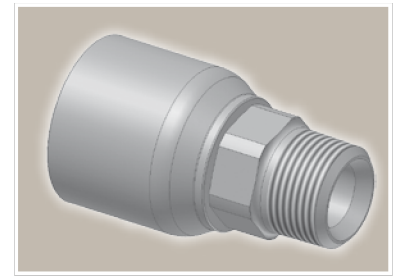
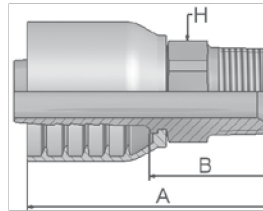

Part Number	Hose I.D.				Thread NPTF	A mm	B mm	H	
	DN	Inch	Size	mm				mm	Inch
10173-12-12-SM	19	3/4	-12	19.1	3/4x14	90	42	30	
10173-16-12-SM	19	3/4	-12	19.1	1x11 1/2	96	48	36	
10173-16-16-SM	25	1	-16	25.4	1x11 1/2	100	50	36	
10173-20-20-SM	31	1 1/4	-20	31.8	1 1/4x11 1/2	125	61	46	
10173-24-24-SM	38	1 1/2	-24	38.1	1 1/2x11 1/2	124	62	50	
10173-32-32	51	2	-32	50.8	2x11 1/2	141	73	2 1/2	

# 03

## Male JIC 37° – Rigid Straight

ISO12151-5-S – AGJ

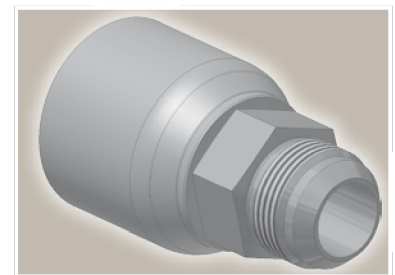
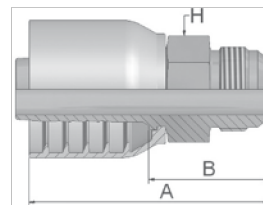

Part Number	Hose I.D.				Thread UNF	A mm	B mm	H	
	DN	Inch	Size	mm				mm	mm
10373-12-12-SM	19	3/4	-12	19.1	1 1/16x12	89	41	30	
10373-16-12-SM	19	3/4	-12	19.1	1 5/16x12	93	45	36	
10373-16-16-SM	25	1	-16	25.4	1 5/16x12	97	47	36	
10373-20-16-SM	25	1	-16	25.4	1 5/8x12	102	52	46	
10373-20-20-SM	31	1 1/4	-20	31.8	1 5/8x12	118	54	46	
10373-24-20-SM	31	1 1/4	-20	31.8	1 7/8x12	118	54	50	
10373-24-24-SM	38	1 1/2	-24	38.1	1 7/8x12	122	59	50	
10373-32-32-SM	51	2	-32	50.8	2 1/2x12	143	72	65	

Approved **fitting series** for hose types:

**73** 731 731TC

## 06 Female JIC 37° – Swivel Straight

ISO12151-5-SWS – DKJ

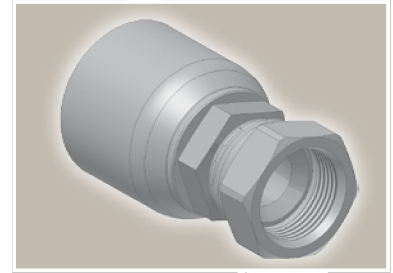
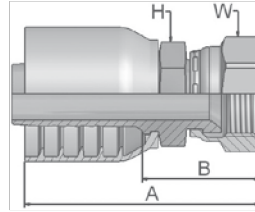

Part Number	Hose I.D.				Thread UNF	A mm	B mm	H		W	
	DN	Inch	Size	mm				mm	Inch	mm	Inch
10673-12-12-SM	19	3/4	-12	19.1	1 1/16x12	93	45	30		32	
10673-16-12	19	3/4	-12	19.1	1 5/16x12	99	51	36		41	
10673-16-16-SM	25	1	-16	25.4	1 5/16x12	103	52	36		41	
10673-20-16	25	1	-16	25.4	1 5/16x12	109	59	41		50	
10673-16-20-SM	31	1 1/4	-20	31.8	1 5/16x12	116	52	46		41	
10673-20-20-SM	31	1 1/4	-20	31.8	1 5/8x12	125	61	46		50	
10673-24-20-SM	31	1 1/4	-20	31.8	1 7/8x12	130	66	50		60	
10673-24-24-SM	38	1 1/2	-24	38.1	1 7/8x12	128	66	50		60	
10673-32-24-SM	38	1 1/2	-24	38.1	2 1/2x12	138	76	65		75	
10673-32-32-SM	51	2	-32	50.8	2 1/2x12	150	79	65		75	

## 37 Female JIC 37° – Swivel 45° Elbow

ISO 12151-5-SWE 45° – DKJ 45°

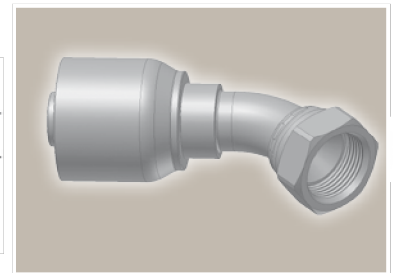
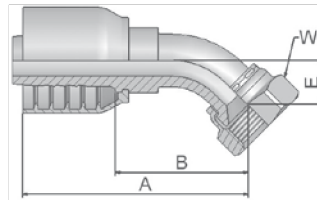

Part Number	Hose I.D.				Thread UNF	A mm	B mm	E mm	W mm
	DN	Inch	Size	mm					
13773-12-12-SM	19	3/4	-12	19.1	1 1/16x12	104	56	22	32
13773-16-12-SM	19	3/4	-12	19.1	1 5/16x12	107	59	24	41
13773-16-16-SM	25	1	-16	25.4	1 5/16x12	119	69	24	41
13773-20-16-SM	25	1	-16	25.4	1 5/8x12	143	92	47	55
13773-20-20-SM	31	1 1/4	-20	31.8	1 5/8x12	171	107	47	50
13773-24-20-SM	31	1 1/4	-20	31.8	1 7/8x12	172	108	48	60
13773-24-24-SM	38	1 1/2	-24	38.1	1 7/8x12	194	132	58	60
13773-32-24-SM	38	1 1/2	-24	38.1	2 1/2x12	208	145	72	75
13773-32-32-SM	51	2	-32	50.8	2 1/2x12	251	179	72	75

Approved **fitting series** for hose types:

73 731 731TC

# 39 Female JIC 37° – Swivel 90° Elbow

ISO 12151-5-SWES – DKJ 90°

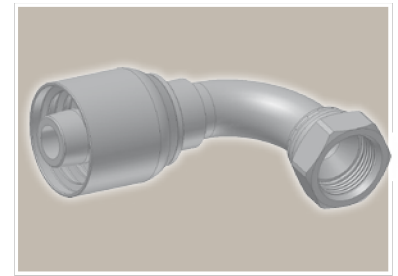
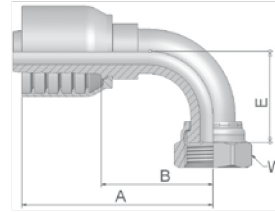

Part Number	Hose I.D.				Thread UNF	A mm	B mm	E mm	W mm
	DN	Inch	Size	mm					
13973-12-12-SM	19	3/4	-12	19.1	1 1/16x12	101	53	48	32
13973-16-12-SM	19	3/4	-12	19.1	1 5/16x12	101	53	56	41
13973-16-16-SM	25	1	-16	25.4	1 5/16x12	118	67	56	41
13973-20-16-SM	25	1	-16	25.4	1 5/8x12	118	67	85	55
13973-20-20-SM	31	1 1/4	-20	31.8	1 5/8x12	150	87	85	50
13973-24-20-SM	31	1 1/4	-20	31.8	1 7/8x12	151	87	102	60
13973-24-24-SM	38	1 1/2	-24	38.1	1 7/8x12	194	119	102	60
13973-32-24-SM	38	1 1/2	-24	38.1	2 1/2x12	168	106	152	75
13973-32-32-SM	51	2	-32	50.8	2 1/2x12	229	157	152	75

Approved **fitting series** for hose types:

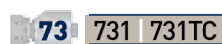

## 15/4A ISO 6162-1 Flange Straight

ISO 12151-3-S-L – SFL  
(35.0 MPa/ 5000 psi)

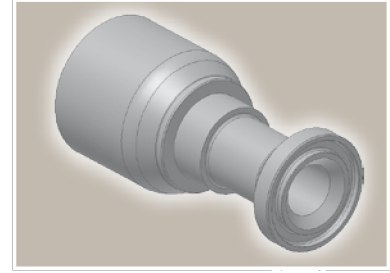
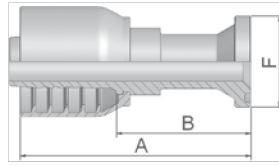

Part Number	Hose I.D.				Flange Inch	A mm	B mm	F mm
	DN	Inch	Size	mm				
11573-12-12	19	3/4	-12	19.1	3/4	110	62	38
11573-16-12	19	3/4	-12	19.1	1	110	62	45
11573-12-16	25	1	-16	25.4	3/4	117	67	38
11573-16-16	25	1	-16	25.4	1	117	67	45
14A73-20-16	25	1	-16	25.4	1 1/4	85	34	51
11573-16-20	31	1 1/4	-20	31.8	1	133	69	45
14A73-20-20	31	1 1/4	-20	31.8	1 1/4	141	77	51
14A73-24-20	31	1 1/4	-20	31.8	1 1/2	104	40	60
14A73-20-24	38	1 1/2	-24	38.1	1 1/4	142	80	51
14A73-24-24	38	1 1/2	-24	38.1	1 1/2	166	103	60
14A73-32-24	38	1 1/2	-24	38.1	2	113	50	71
14A73-24-32	51	2	-32	50.8	1 1/2	156	84	60
14A73-32-32	51	2	-32	50.8	2	220	148	71

SAE flange halves see in section Eb.

Fittings with standard O-ring seals can be used for temperatures from -40 °C up to +105 °C.  
O-rings see section Eb. Special O-rings are available on request.

## 17/4F ISO 6162-1 Flange 45° Elbow

ISO 12151-3 – E45S – L – SFL 45°  
(35.0 MPa/ 5000 psi)

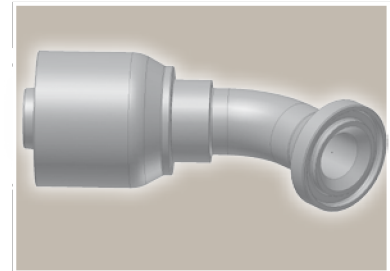
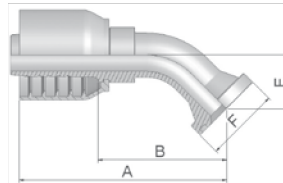

Part Number	Hose I.D.				Flange Inch	A mm	B mm	E mm	F mm
	DN	Inch	Size	mm					
11773-12-12	19	3/4	-12	19.1	3/4	119	71	27	38
11773-16-12	19	3/4	-12	19.1	1	109	64	26	44
11773-12-16	25	1	-16	25.4	3/4	130	80	32	38
11773-16-16	25	1	-16	25.4	1	127	77	32	45
14F73-20-16	25	1	-16	25.4	1 1/4	136	85	32	51
14F73-20-20	31	1 1/4	-20	31.8	1 1/4	160	96	35	51
14F73-24-20	31	1 1/4	-20	31.8	1 1/2	162	102	38	60
14F73-24-24	38	1 1/2	-24	38.1	1 1/2	178	115	44	60
14F73-32-24	38	1 1/2	-24	38.1	2	177	114	43	71
14F73-24-32	51	2	-32	50.8	1 1/2	192	120	53	60
14F73-32-32	51	2	-32	50.8	2	224	153	62	71

SAE flange halves see in section Eb.

Fittings with standard O-ring seals can be used for temperatures from -40 °C up to +105 °C.  
O-rings see section Eb. Special O-rings are available on request.

Approved **fitting series** for hose types:

**73** 731 731TC

## 19/4N ISO 6162-1 Flange 90° Elbow

ISO 12151-3-E-L – SFL 90°  
(35.0 MPa/ 5000 psi)

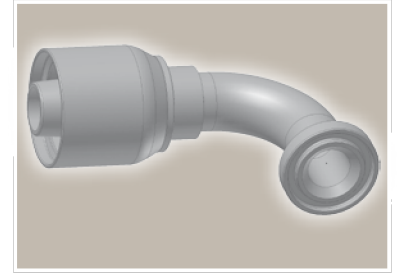
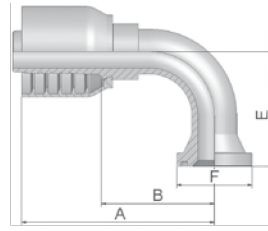

Part Number	Hose I.D.				Flange Inch	A mm	B mm	E mm	F mm
	DN	Inch	Size	mm					
11973-12-12	19	3/4	-12	19.1	3/4	109	61	58	38
11973-16-12	19	3/4	-12	19.1	1	102	54	58	45
11973-12-16	25	1	-16	25.4	3/4	121	70	70	38
11973-16-16	25	1	-16	25.4	1	118	67	70	45
14N73-20-16	25	1	-16	25.4	1 1/4	128	78	68	51
14N73-24-16	25	1	-16	25.4	1 1/2	132	81	70	60
11973-16-20	31	1 1/4	-20	31.8	1	133	69	70	44
14N73-20-20	31	1 1/4	-20	31.8	1 1/4	155	91	90	51
14N73-24-20	31	1 1/4	-20	31.8	1 1/2	155	91	90	60
14N73-24-24	38	1 1/2	-24	38.1	1 1/2	166	103	93	60
14N73-32-24	38	1 1/2	-24	38.1	2	166	103	92	71
14N73-32-32	51	2	-32	50.8	2	220	148	133	71

SAE flange halves see in section Eb.

Fittings with standard O-ring seals can be used for temperatures from -40 °C up to +105 °C.  
O-rings see section Eb. Special O-rings are available on request.

## 6A ISO 6162-2 Flange Straight

ISO 12151-3-S-S – SFS  
(42.0 MPa/ 6000 psi)

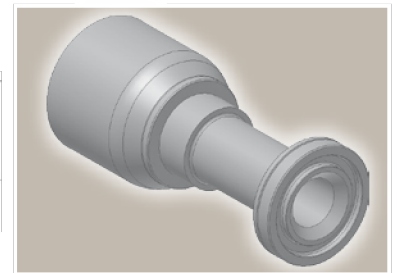
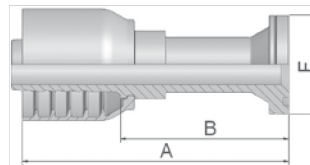

Part Number	Hose I.D.				Flange Inch	A mm	B mm	F mm
	DN	Inch	Size	mm				
16A73-8-12	19	3/4	-12	19.1	1/2	123	75	32
16A73-12-12	19	3/4	-12	19.1	3/4	130	82	41
16A73-16-12	19	3/4	-12	19.1	1	135	87	48
16A73-20-12	19	3/4	-12	19.1	1 1/4	96	48	54
16A73-12-16	25	1	-16	25.4	3/4	124	73	41
16A73-16-16	25	1	-16	25.4	1	131	81	48
16A73-20-16	25	1	-16	25.4	1 1/4	142	91	54
16A73-16-20	31	1 1/4	-20	31.8	1	147	83	48
16A73-20-20	31	1 1/4	-20	31.8	1 1/4	149	85	54
16A73-24-20	31	1 1/4	-20	31.8	1 1/2	121	57	64
16A73-20-24	38	1 1/2	-24	38.1	1 1/4	158	96	54
16A73-24-24	38	1 1/2	-24	38.1	1 1/2	166	104	64
16A73-32-24	38	1 1/2	-24	38.1	2	129	66	79
16A73-32-32	51	2	-32	50.8	2	194	122	79

SAE flange halves see in section Eb.

Fittings with standard O-ring seals can be used for temperatures from -40 °C up to +105 °C.  
O-rings see section Eb. Special O-rings are available on request.

Approved **fitting series** for hose types:

**73** 731 731TC

## 6F ISO 6162-2 Flange 45° Elbow – Heavy Series

ISO 12151-3 – E45-S – SFS 45°  
(42.0 MPa/ 6000 psi)

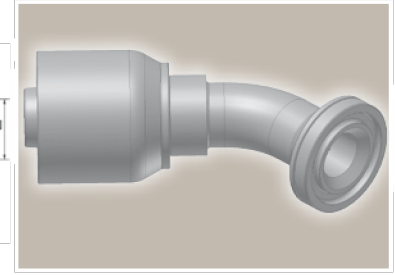
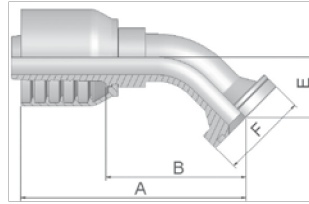

Part Number	Hose I.D.				Flange Inch	A mm	B mm	E mm	F mm
	DN	Inch	Size	mm					
16F73-8-12	19	3/4	-12	19.1	1/2	107	59	27	32
16F73-12-12	19	3/4	-12	19.1	3/4	110	62	26	41
16F73-16-12	19	3/4	-12	19.1	1	110	62	26	48
16F73-20-12	19	3/4	-12	19.1	1 1/4	125	77	32	54
16F73-12-16	25	1	-16	25.4	3/4	123	73	32	41
16F73-16-16	25	1	-16	25.4	1	129	79	32	48
16F73-20-16	25	1	-16	25.4	1 1/4	129	79	32	54
16F73-16-20	31	1 1/4	-20	31.8	1	157	93	33	48
16F73-20-20	31	1 1/4	-20	31.8	1 1/4	163	98	38	54
16F73-24-20	31	1 1/4	-20	31.8	1 1/2	163	99	38	63
16F73-20-24	38	1 1/2	-24	38.1	1 1/4	170	107	44	54
16F73-24-24	38	1 1/2	-24	38.1	1 1/2	178	115	44	64
16F73-32-32	51	2	-32	50.8	2	230	158	56	79

SAE flange halves see in section Eb.

Fittings with standard O-ring seals can be used for temperatures from -40 °C up to +105 °C.  
O-rings see section Eb. Special O-rings are available on request.

## 6N ISO 6162-2 Flange 90° Elbow

ISO 12151-3 – E-S – SFS 90°  
(42.0 MPa/ 6000 psi)

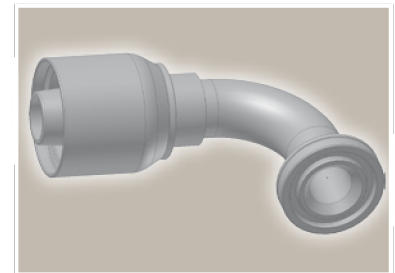
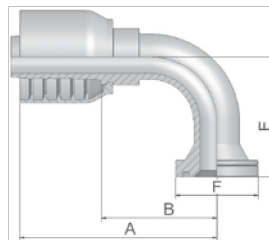

Part Number	Hose I.D.				Flange Inch	A mm	B mm	E mm	F mm
	DN	Inch	Size	mm					
16N73-8-12	19	3/4	-12	19.1	1/2	92	44	58	32
16N73-12-12	19	3/4	-12	19.1	3/4	101	53	58	41
16N73-16-12	19	3/4	-12	19.1	1	111	63	58	48
16N73-20-12	19	3/4	-12	19.1	1 1/4	110	62	63	54
16N73-12-16	25	1	-16	25.4	3/4	109	58	70	41
16N73-16-16	25	1	-16	25.4	1	122	71	70	48
16N73-20-16	25	1	-16	25.4	1 1/4	122	71	70	54
16N73-16-20	31	1 1/4	-20	31.8	1	137	73	90	48
16N73-20-20	31	1 1/4	-20	31.8	1 1/4	172	108	71	54
16N73-24-20	31	1 1/4	-20	31.8	1 1/2	172	108	76	64
16N73-20-24	38	1 1/2	-24	38.1	1 1/4	152	90	104	54
16N73-24-24	38	1 1/2	-24	38.1	1 1/2	166	103	104	64
16N73-32-24	38	1 1/2	-24	38.1	2	166	103	104	79
16N73-24-32	51	2	-32	50.8	1 1/2	188	116	104	64
16N73-32-32	51	2	-32	50.8	2	229	157	138	79

SAE flange halves see in section Eb.

Fittings with standard O-ring seals can be used for temperatures from -40 °C up to +105 °C.  
O-rings see section Eb. Special O-rings are available on request.

Approved **fitting series** for hose types:

**73** 731 731TC

## XA Caterpillar® Flange Straight

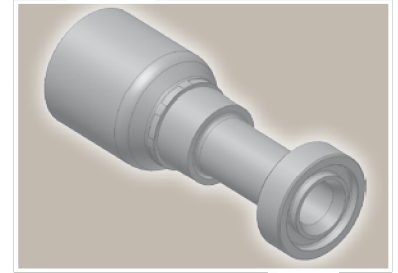
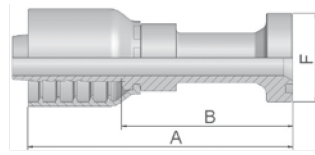

Part Number	Hose I.D.				Flange Inch	A mm	B mm	F mm
	DN	Inch	Size	mm				
1XA73-12-12	19	3/4	-12	19.1	3/4	123	75	41
1XA73-16-12	19	3/4	-12	19.1	1	134	86	48
1XA73-16-16	25	1	-16	25.4	1	138	88	48
1XA73-20-16	25	1	-16	25.4	1 1/4	144	93	54
1XA73-20-20	31	1 1/4	-20	31.8	1 1/4	155	96	54
1XA73-24-20	31	1 1/4	-20	31.8	1 1/2	162	97	64

Fittings with standard O-ring seals can be used for temperatures from -40 °C up to +105 °C.  
O-rings see section Eb. Special O-rings are available on request.

## XF Caterpillar® Flange 45° Elbow

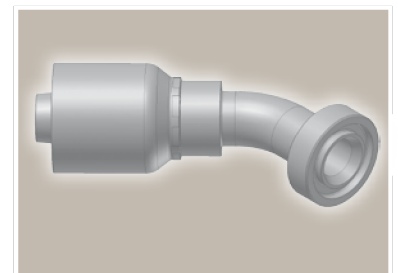
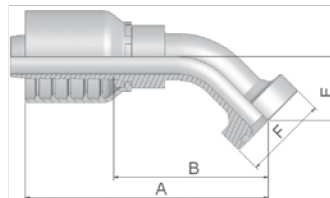

Part Number	Hose I.D.				Flange Inch	A mm	B mm	E mm	F mm
	DN	Inch	Size	mm					
1XF73-12-12	19	3/4	-12	19.1	3/4	123	75	31	41
1XF73-16-12	19	3/4	-12	19.1	1	122	74	31	48
1XF73-16-16	25	1	-16	25.4	1	139	88	36	48
1XF73-20-20	31	1 1/4	-20	31.8	1 1/4	162	98	37	54
1XF73-24-20	31	1 1/4	-20	31.8	1 1/2	182	117	36	64

Fittings with standard O-ring seals can be used for temperatures from -40 °C up to +105 °C.  
O-rings see section Eb. Special O-rings are available on request.

Approved **fitting series** for hose types:

**73** 731 731TC

**XG** Caterpillar® Flange  
60° Elbow

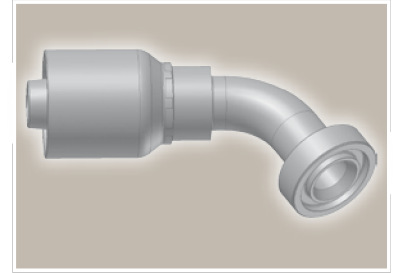
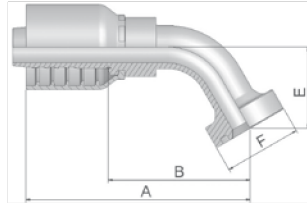

Part Number	Hose I.D.				Flange Inch	A mm	B mm	E mm	F mm
	DN	Inch	Size	mm					
1XG73-12-12	19	3/4	-12	19.1	3/4	41	138	90	42
1XG73-16-16	25	1	-16	25.4	1	48	160	109	50
1XG73-20-16	25	1	-16	25.4	1 1/4	54	153	103	48

Fittings with standard O-ring seals can be used for temperatures from -40 °C up to +105 °C.  
O-rings see section Eb. Special O-rings are available on request.

**XN** Caterpillar® Flange  
90° Elbow

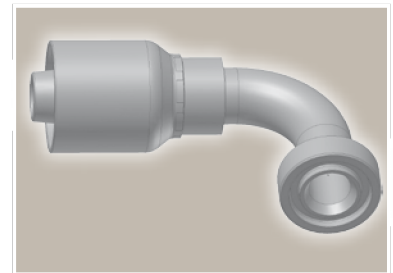
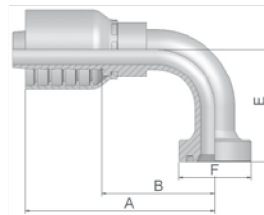

Part Number	Hose I.D.				Flange Inch	A mm	B mm	E mm	F mm
	DN	Inch	Size	mm					
1XN73-12-12	19	3/4	-12	19.1	3/4	111	63	63	41
1XN73-16-12	19	3/4	-12	19.1	1	111	63	62	48
1XN73-16-16	25	1	-16	25.4	1	128	78	74	48
1XN73-20-16	25	1	-16	25.4	1 1/4	122	71	74	54
1XN73-20-20	31	1 1/4	-20	31.8	1 1/4	172	108	77	54

Fittings with standard O-ring seals can be used for temperatures from -40 °C up to +105 °C.  
O-rings see section Eb. Special O-rings are available on request.

Approved **fitting series** for hose types:

**73** 731 731TC



# JC

## Female ORFS Swivel – Straight Short

ISO 12151-1 – SWSA  
SAE J516 – ORFS

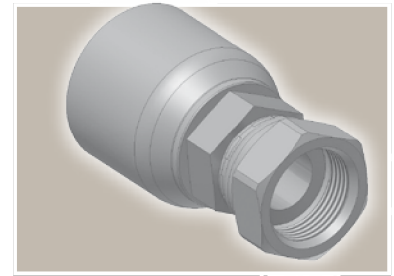
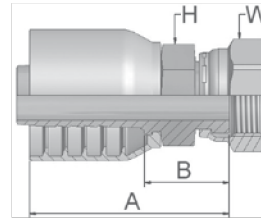

Part Number	Hose I.D.				Thread UNF	A mm	B mm	H mm	W mm
	DN	Inch	Size	mm					
1JC73-12-12-SM	19	3/4	-12	19.1	1 3/16x12	81	33	30	36
1JC73-16-16-SM	25	1	-16	25.4	1 7/16x12	89	38	36	41
1JC73-20-20-SM	31	1 1/4	-20	31.8	1 11/16x12	106	42	46	50
1JC73-24-24-SM	38	1 1/2	-24	38.1	2x12	117	44	50	60

# JS

## ORFS Swivel Female (Long)

ISO 12151-1-SWSB  
SAE J516 – ORFS

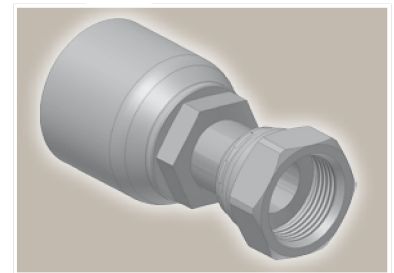
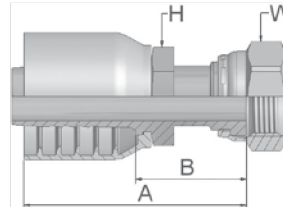

Part Number	Hose I.D.				Thread UNF	A mm	B mm	H mm Inch	W mm Inch
	DN	Inch	Size	mm					
1JS73-12-12-SM	19	3/4	-12	19.1	1 3/16x12	94	46	30	36
1JS73-16-12-SM	19	3/4	-12	19.1	1 7/16x12	107	58	36	41
1JS73-16-16-SM	25	1	-16	25.4	1 7/16x12	103	52	36	41
1JS73-20-16-SM	25	1	-16	25.4	1 11/16x12	114	64	41	50
1JS73-20-20-SM	31	1 1/4	-20	31.8	1 11/16x12	117	54	46	50
1JS73-24-24-SM	38	1 1/2	-24	38.1	2x12	120	57	50	60

Approved **fitting series** for hose types:

**73** 731 731TC

## J7 Female ORFS – Swivel 45° Elbow

ISO 12151-1 – SWE 45°  
SAE J516 – ORFS 45°

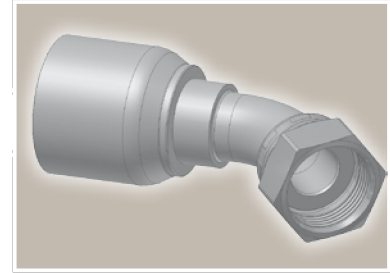
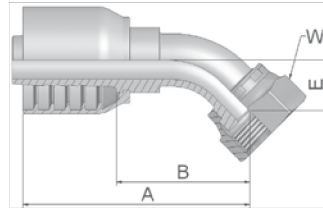

Part Number	Hose I.D.				Thread UNF	A mm	B mm	E mm	W mm
	DN	Inch	Size	mm					
1J773-12-12-SM	19	3/4	-12	19.1	1 3/16x12	105	57	21	36
1J773-16-12-SM	19	3/4	-12	19.1	1 7/16x12	107	59	24	41
1J773-16-16-SM	25	1	-16	25.4	1 7/16x12	119	69	24	41
1J773-20-16-SM	25	1	-16	25.4	1 11/16x12	131	80	26	50
1J773-20-20-SM	31	1 1/4	-20	31.8	1 11/16x12	154	90	30	50
1J773-20-20	31	1 1/4	-20	31.8	1 11/16x12	147	83	25	7/8
1J773-24-20-SM	31	1 1/4	-20	31.8	2x12	164	100	40	60

## J9 Female ORFS – Swivel 90° Elbow – Short Drop

ISO 12151-1 – SWES  
SAE J516 – ORFS 90°

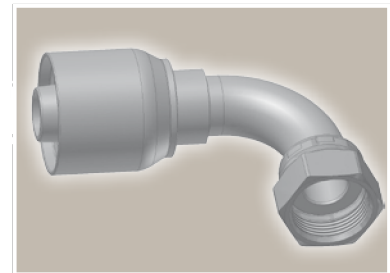
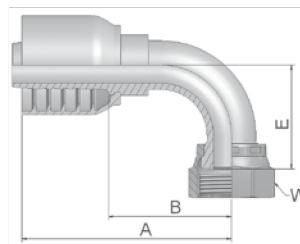

Part Number	Hose I.D.				Thread UNF	A mm	B mm	E mm	W mm
	DN	Inch	Size	mm					
1J973-12-12-SM	19	3/4	-12	19.1	1 3/16x12	101	53	48	36
1J973-16-12-SM	19	3/4	-12	19.1	1 7/16x12	114	66	56	41
1J973-16-16-SM	25	1	-16	25.4	1 7/16x12	120	70	56	41
1J973-20-16-SM	25	1	-16	25.4	1 11/16x12	127	77	64	50
1J973-20-20	31	1 1/4	-20	31.8	1 11/16x12	148	84	64	7/8
1J973-20-20-SM	31	1 1/4	-20	31.8	1 11/16x12	151	87	69	50
1J973-24-24-SM	38	1 1/2	-24	38.1	2x12	166	103	82	60

Approved **fitting series** for hose types:

73 731 731TC

**JM**

**ORFS Male**

ISO 12151-1-S – SAE J516

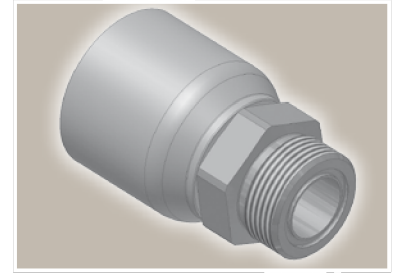
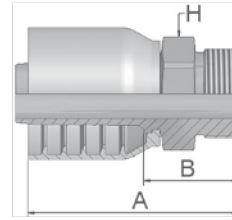

Part Number	Hose I.D.				Thread UNF	A mm	B mm	H mm
	DN	Inch	Size	mm				
1JM73-12-12-SM	19	3/4	-12	19.1	1 3/16x12	86	38	32
1JM73-16-12-SM	19	3/4	-12	19.1	1 7/16x12	87	39	41
1JM73-16-16-SM	25	1	-16	25.4	1 7/16x12	93	42	41
1JM73-20-16-SM	25	1	-16	25.4	1 11/16x12	89	39	46
1JM73-20-20-SM	31	1 1/4	-20	31.8	1 11/16x12	106	42	46

JM fittings are supplied without O-ring.  
O-rings see section Eb. Special O-rings are available on request.

73 Series

Approved **fitting series** for hose types:

**73** 731 731TC

## FG Male French Gas Series Rigid – Straight (24° Cone)

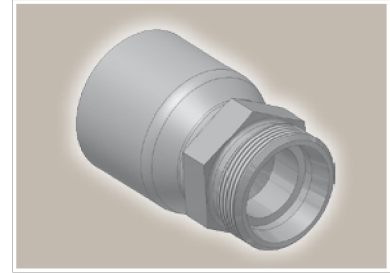
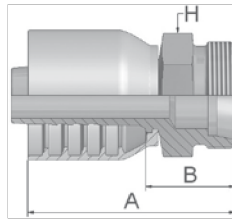

Part Number	Hose I.D.				Thread metric	Tube O.D. mm	A mm	B mm	H mm
	DN	Inch	Size	mm					
1FG73-27-12	19	3/4	-12	19.1	M36x1.5	26.75	82	33	36
1FG73-33-16	25	1	-16	25.4	M45x1.5	33.50	91	39	46

## F2 Female French Gas Series Swivel – 90° Elbow

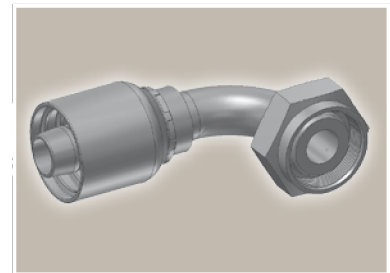
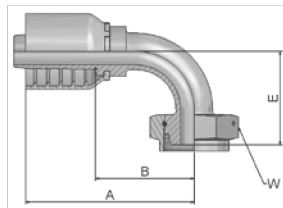

Part Number	Hose I.D.				Thread metric	A mm	B mm	E mm	W mm
	DN	Inch	Size	mm					
1F273-33-16	25	1	-16	25.4	M45x1.5	122	71	68	55

Approved **fitting series** for hose types:

**73** 731 731TC

## F4 Female French Gas Series Swivel – Straight (Ball Nose)

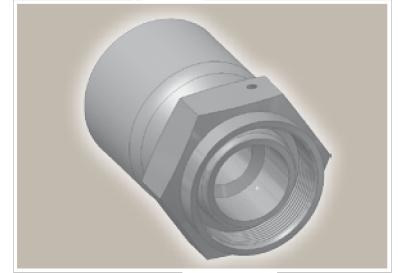
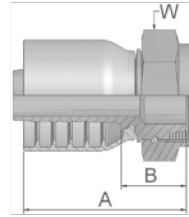

Part Number	Hose I.D.				Thread metric	Tube O.D. mm	A mm	B mm	W mm
	DN	Inch	Size	mm					
1F473-27-12	19	3/4	-12	19.1	M36x1.5	27	83	33	46
1F473-33-16	25	1	-16	25.4	M45x1.5	33	85	34	55





Approved **fitting series** for hose types:

**73** 731 731TC

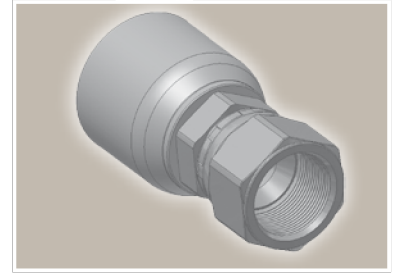
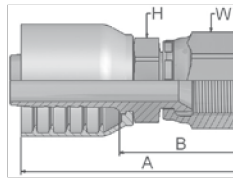
# XU Female Metric – Swivel Straight (30° Flare)

JIS B8363



Part Number	 Hose I.D.				 Thread	A mm	B mm	 H mm	 W mm
	DN	Inch	Size	mm	metric				
1XU73-12-12	19	3/4	-12	19.1	M30x1.5	76	28	32	36
1XU73-16-16	25	1	-16	25.4	M33x1.5	85	35	36	41

Approved **fitting series** for hose types:

**73** 731 731TC

## Large range of special hose fittings for the MRO market

The demand for special hose fittings is part of our everyday business.

In order to meet this demand with the authority expected, the Hose Products Division Europe has extended its standard offer with special hose fittings such as an extra drop length, etc.

The following is an overview of our special hose fitting selection:

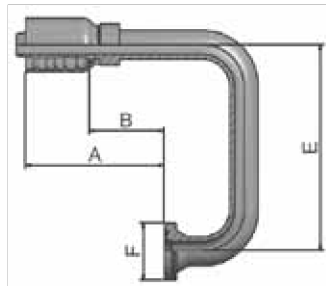

Further special hose fittings are available on request.







Part Number	Description	Hose I.D. Size	Flange Inch	A mm	B mm	E mm	F mm
11973-12-12-SL100	SAE 5000 psi 90° elbow - drop length 100 mm	-12	3/4	109	61	100	38
11973-12-12-SL150	SAE 5000 psi 90° elbow - drop length 150 mm	-12	3/4	109	61	150	38
11973-12-12-SL180	SAE 5000 psi 90° elbow - drop length 180 mm	-12	3/4	109	61	180	38
11973-16-16-SL100	SAE 5000 psi 90° elbow - drop length 100 mm	-16	1	118	67	100	45
11973-16-16-SL150	SAE 5000 psi 90° elbow - drop length 150 mm	-16	1	118	67	150	45
11973-16-16-SL90	SAE 5000 psi 90° elbow - drop length 90 mm	-16	1	118	67	90	45
14N73-20-20-SL150	SAE 5000 psi 90° elbow - drop length 150 mm	-20	1 1/4	155	91	150	51
16N73-12-12-SL100	SAE 6000 psi 90° elbow - drop length 100 mm	-12	3/4	101	53	100	41
16N73-12-12-SL140	SAE 6000 psi 90° elbow - drop length 140 mm	-12	3/4	101	53	140	41
16N73-12-12-SL150	SAE 6000 psi 90° elbow - drop length 150 mm	-12	3/4	101	53	150	41
16N73-12-12-SL85	SAE 6000 psi 90° elbow - drop length 85 mm	-12	3/4	101	53	85	41
16N73-16-12-SL100	SAE 6000 psi 90° elbow - drop length 100 mm	-12	1	111	63	100	48
16N73-16-12-SL116	SAE 6000 psi 90° elbow - drop length 116 mm	-12	1	111	63	116	48
16N73-16-12-SL120	SAE 6000 psi 90° elbow - drop length 120 mm	-12	1	111	63	120	48
16N73-16-16-SL100	SAE 6000 psi 90° elbow - drop length 100 mm	-16	1	118	67	100	48
16N73-16-16-SL110	SAE 6000 psi 90° elbow - drop length 110 mm	-16	1	122	71	110	48
16N73-16-16-SL116	SAE 6000 psi 90° elbow - drop length 116 mm	-16	1	128	77	116	48
16N73-16-16-SL125	SAE 6000 psi 90° elbow - drop length 125 mm	-16	1	118	67	125	48
16N73-16-16-SL140	SAE 6000 psi 90° elbow - drop length 140 mm	-16	1	122	71	140	48
16N73-16-16-SL175	SAE 6000 psi 90° elbow - drop length 175 mm	-16	1	122	71	175	48
16N73-16-16SL150	SAE 6000 psi 90° elbow - drop length 150 mm	-16	1	117	67	150	48
16N73-20-16-SL120	SAE 6000 psi 90° elbow - drop length 120 mm	-16	1 1/4	122	71	120	54
16N73-20-16-SL160	SAE 6000 psi 90° elbow - drop length 160 mm	-16	1 1/4	122	71	160	54
16N73-20-20-SL100	SAE 6000 psi 90° elbow - drop length 100 mm	-20	1 1/4	155	91	100	54
16N73-20-20-SL180	SAE 6000 psi 90° elbow - drop length 180 mm	-20	1 1/4	155	91	180	54
16N73-20-20SL145	SAE 6000 psi 90° elbow - drop length 145 mm	-20	1 1/4	155	91	145	54
16N73-24-24-SL90	SAE 6000 psi 90° elbow - drop length 90 mm	-24	1 1/2	166	103	90	64

Approved **fitting series** for hose types:

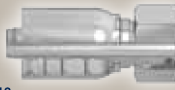
**73** 731 731TC

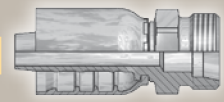

## DIN – Metric

Page Dd-1 – Dd-4

<p><b>CA</b></p> <p>Dd-1</p>  <p><b>Female Metric 24° Light Series with O-Ring Swivel – Straight</b> ISO 12151-2-SWS-L – DKOL</p>	<p><b>CE</b></p> <p>Dd-1</p>  <p><b>Female Metric 24° Light Series with O-Ring Swivel – 45° Elbow</b> ISO 12151-2-SWE 45°-L – DKOL 45°</p>	<p><b>CF</b></p> <p>Dd-2</p>  <p><b>Female Metric 24° Light Series with O-Ring Swivel – 90° Elbow</b> ISO 12151-2-SWE-L – DKOL 90°</p>	<p><b>D0</b></p> <p>Dd-2</p>  <p><b>Male Metric 24° Light Series – Rigid Straight</b> ISO 12151-2-S-L – CEL</p>
<p><b>C9</b></p> <p>Dd-3</p>  <p><b>Female Metric 24° – Swivel Heavy Series with O-Ring Straight</b> ISO 12151-2-SWS-S – DKOS</p>	<p><b>OC</b></p> <p>Dd-3</p>  <p><b>Female Metric 24° – Swivel Heavy Series with O-Ring 45° Elbow</b> ISO 12151-2 – SWE 45°-S – DKOS 45°</p>	<p><b>1C</b></p> <p>Dd-4</p>  <p><b>Female Metric 24° – Swivel Heavy Series with O-Ring 90° Elbow</b> ISO 12151-2-SWE-S – DKOS 90°</p>	<p><b>D2</b></p> <p>Dd-4</p>  <p><b>Male Metric 24° – Rigid Heavy Series – Straight</b> ISO 12151-2-S-S – CES</p>



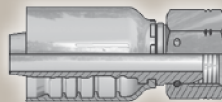
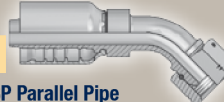
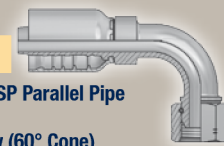
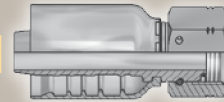
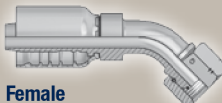

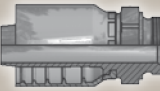
## BSP

Page Dd-5 – Dd-8

<p><b>92</b></p> <p>Dd-5</p>  <p><b>Female BSP Parallel Pipe Swivel – Straight (60° Cone)</b> BS5200-A – DKR</p>	<p><b>B1</b></p> <p>Dd-5</p>  <p><b>Female BSP Parallel Pipe Swivel 45° Elbow (60° Cone)</b> BS 5200-D – DKR 45°</p>	<p><b>B2</b></p> <p>Dd-6</p>  <p><b>Female BSP Parallel Pipe Swivel 90° Elbow (60° Cone)</b> BS 5200-B – DKR 90°</p>	<p><b>EA</b></p> <p>Dd-6</p>  <p><b>BSP Swivel Female with O-Ring (60° Cone)</b> BS 5200 – ISO 12151-6 – DKOR</p>
<p><b>EB</b></p> <p>Dd-7</p>  <p><b>BSP Swivel Female with O-Ring 45° Elbow (60° Cone)</b> BS 5200 – ISO 12151-6 – DKOR 45°</p>	<p><b>EC</b></p> <p>Dd-7</p>  <p><b>BSP Swivel Female with O-Ring 90° Elbow (60° Cone)</b> BS 5200 – ISO 12151-6 – DKOR 90°</p>	<p><b>D9</b></p> <p>Dd-8</p>  <p><b>Male BSP Parallel Pipe Rigid – Straight (60° Cone)</b> BS5200 – AGR</p>	

## SAE

Page Dd-9 – Dd-11

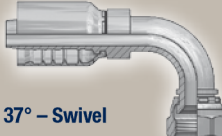
<p><b>01</b></p> <p>Dd-9</p>  <p><b>Male NPTF Pipe Rigid – Straight</b> SAE J476A / J516 – AGN</p>	<p><b>03</b></p> <p>Dd-9</p>  <p><b>Male JIC 37° – Rigid Straight</b> ISO12151-5-S – AGJ</p>	<p><b>06</b></p> <p>Dd-10</p>  <p><b>Female JIC 37° – Swivel Straight</b> ISO12151-5-SWS – DKJ</p>	<p><b>37</b></p> <p>Dd-11</p>  <p><b>Female JIC 37° – Swivel 45° Elbow</b> ISO 12151-5-SWE 45° – DKJ 45°</p>
<p><b>39</b></p> <p>Dd-11</p>  <p><b>Female JIC 37° – Swivel 90° Elbow</b> ISO 12151-5-SWES – DKJ 90°</p>			



# Flange

Page Dd-12 – Dd-22

<p><b>15/4A</b> Dd-12 ISO 6162-1 Flange Straight ISO 12151-3-S-L – SFL (35.0 MPa/ 5000 psi)</p> 	<p><b>17/4F</b> Dd-13 ISO 6162-1 Flange 45° Elbow ISO 12151-3 – E45S – L – SFL 45° (35.0 MPa/ 5000 psi)</p> 	<p><b>19/4N</b> Dd-14 ISO 6162-1 Flange 90° Elbow ISO 12151-3-E-L – SFL 90° (35.0 MPa/ 5000 psi)</p> 	<p><b>6A</b> Dd-15 ISO 6162-2 Flange Straight ISO 12151-3-S-S – SFS (42.0 MPa/ 6000 psi)</p> 
<p><b>6E</b> Dd-16 ISO 6162-2 Flange 30° Elbow SFS 30° (42.0 MPa/ 6000 psi)</p> 	<p><b>6F</b> Dd-16 ISO 6162-2 Flange 45° Elbow – Heavy Series ISO 12151-3 – E45-S – SFS 45° (42.0 MPa/ 6000 psi)</p> 	<p><b>6N</b> Dd-17 ISO 6162-2 Flange 90° Elbow ISO 12151-3 – E-S – SFS 90° (42.0 MPa/ 6000 psi)</p> 	<p><b>X5</b> Dd-18 Flange – Straight Full flange system for ISO 6162-1 or ISO 6162-2</p> 
<p><b>X7</b> Dd-18 Flange – 45° Elbow Full flange system for ISO 6162-1 or ISO 6162-2</p> 	<p><b>X9</b> Dd-19 Flange – 90° Elbow Full flange system for ISO 6162-1 or ISO 6162-2</p> 	<p><b>XA</b> Dd-19 Caterpillar® Flange Straight</p> 	<p><b>XF</b> Dd-20 Caterpillar® Flange 45° Elbow</p> 
<p><b>XG</b> Dd-20 Caterpillar® Flange 60° Elbow</p> 	<p><b>XN</b> Dd-21 Caterpillar® Flange 90° Elbow</p> 	<p><b>K5</b> Dd-21 Komatsu® Flange Straight</p> 	<p><b>K7</b> Dd-22 Komatsu® Flange 45° Elbow</p> 
<p><b>K9</b> Dd-22 Komatsu® Flange 90° Elbow</p> 			

# ORFS

Page Dd-23 – Dd-25

<p><b>JC</b> Dd-23 Female ORFS Swivel – Straight Short ISO 12151-1 – SWSA SAE J516 – ORFS</p> 	<p><b>J7</b> Dd-23 Female ORFS – Swivel 45° Elbow ISO 12151-1 – SWE 45° SAE J516 – ORFS 45°</p> 	<p><b>J9</b> Dd-24 Female ORFS – Swivel 90° Elbow – Short Drop ISO 12151-1 – SWES SAE J516 – ORFS 90°</p> 	<p><b>J1</b> Dd-24 Female ORFS – Swivel 90° Elbow – Long Drop ISO 12151-1 – SWEL SAE J516 – ORFS 90° L</p> 
<p><b>JM</b> Dd-25 ORFS Male ISO 12151-1-S – SAE J516</p> 			

**A large range of special hose fittings for the MRO market can be found on page Dd-27**

# French Standard

Page Dd-26

**FG**  
Dd-26  
Male French Gas Series  
Rigid – Straight (24° Cone)





**CA** **Female Metric 24°  
Light Series with O-Ring  
Swivel – Straight**  
ISO 12151-2-SWS-L – DKOL

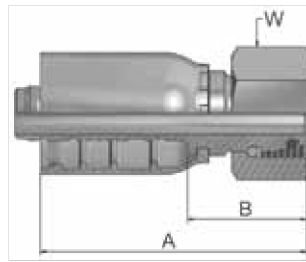

Part Number	Hose I.D.				Thread metric	Tube O.D. mm	A mm	B mm	W mm
	DN	Inch	Size	mm					
1CA77-15-8	12	1/2	-8	12.7	M22x1.5	15	63	28	27
1CA77-18-10	16	5/8	-10	15.9	M26x1.5	18	66	27	32
1CA77-18-12	19	3/4	-12	19.1	M26x1.5	18	74	28	32
1CA77-22-12	19	3/4	-12	19.1	M30x2	22	73	27	36
1CA77-22-16	25	1	-16	25.4	M30x2	22	88	33	36
1CA77-28-16	25	1	-16	25.4	M36x2	28	89	35	41
1CA77-35-20	31	1 1/4	-20	31.8	M45x2	35	100	37	50
1CA77-42-24	38	1 1/2	-24	38.1	M52x2	42	106	39	60

Fittings with standard O-ring seals can be used for temperatures from -40 °C up to +105 °C.  
O-rings see section Eb. Special O-rings are available on request.

**CE** **Female Metric 24°  
Light Series with O-Ring  
Swivel – 45° Elbow**  
ISO 12151-2-SWE 45°-L – DKOL 45°

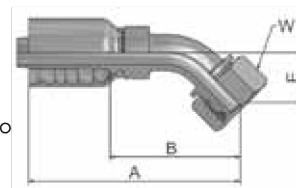

Part Number	Hose I.D.				Thread metric	Tube O.D. mm	A mm	B mm	E mm	W mm
	DN	Inch	Size	mm						
1CE77-15-8	12	1/2	-8	12.7	M22x1.5	15	83	48	23	27
1CE77-22-12	19	3/4	-12	19.1	M30x2	22	120	74	29	36
1CE77-28-16	25	1	-16	25.4	M36x2	28	142	88	33	41
1CE77-35-20	31	1 1/4	-20	31.8	M45x2	35	162	98	37	50
1CE77-42-24	38	1 1/2	-24	38.1	M52x2	42	201	134	49	60

Fittings with standard O-ring seals can be used for temperatures from -40 °C up to +105 °C.  
O-rings see section Eb. Special O-rings are available on request.

Approved **fitting series** for hose types:

77	387	387ST	387TC	487	487ST	487TC	size -20 up to -32	787	787TC	797	797TC
----	-----	-------	-------	-----	-------	-------	--------------------	-----	-------	-----	-------

**CF** **Female Metric 24°  
Light Series with O-Ring  
Swivel – 90° Elbow**

ISO 12151-2-SWE-L – DKOL 90°

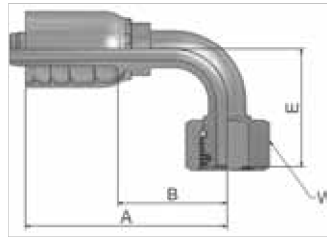

Part Number	Hose I.D.				Thread metric	Tube O.D. mm	A mm	B mm	E mm	W mm
	DN	Inch	Size	mm						
1CF77-15-8	12	1/2	-8	12.7	M22x1.5	15	76	41	44	27
1CF77-18-10	16	5/8	-10	15.9	M26x1.5	18	92	53	49	32
1CF77-18-12	19	3/4	-12	19.1	M26x1.5	18	108	62	56	32
1CF77-22-12	19	3/4	-12	19.1	M30x2	22	108	62	59	36
1CF77-28-16	25	1	-16	25.4	M36x2	28	131	77	69	41
1CF77-35-20	31	1 1/4	-20	31.8	M45x2	35	151	87	79	50
1CF77-42-24	38	1 1/2	-24	38.1	M52x2	42	179	112	101	60

Fittings with standard O-ring seals can be used for temperatures from -40 °C up to +105 °C.  
O-rings see section Eb. Special O-rings are available on request.

**DO** **Male Metric 24°  
Light Series – Rigid  
Straight**

ISO 12151-2-S-L – CEL

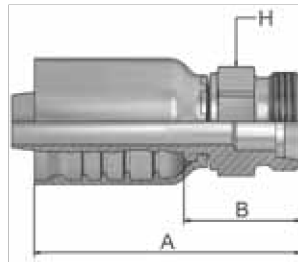

Part Number	Hose I.D.				Thread metric	A mm	B mm	H mm
	DN	Inch	Size	mm				
1D077-15-8	12	1/2	-8	12.7	M22x1.5 I	61	27	22
1D077-18-10	16	5/8	-10	15.9	M26x1.5 I	68	30	27
1D077-22-12	19	3/4	-12	19.1	M30x2	82	36	30
1D077-28-16	25	1	-16	25.4	M30x2	92	38	36

Approved **fitting series** for hose types:

**77** | 387 | 387ST | 387TC | 487 | 487ST | 487TC | size -20 up to -32 | 787 | 787TC | 797 | 797TC

## C9 Female Metric 24° – Swivel Heavy Series with O-Ring Straight

ISO 12151-2-SWS-S – DKOS

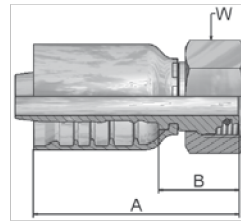

Part Number	Hose I.D.				Thread metric	A mm	B mm	W mm
	DN	Inch	Size	mm				
1C977-12-8	12	1/2	-8	12.7	M20x1.5	61	26	24
1C977-16-8	12	1/2	-8	12.7	M24x1.5	60	25	30
1C977-16-10	16	5/8	-10	15.9	M24x1.5	67	28	30
1C977-20-10	16	5/8	-10	15.9	M30x2	67	28	36
1C977-20-12	19	3/4	-12	19.1	M30x2	76	30	36
1C977-25-12-SW41	19	3/4	-12	19.1	M36x2	77	31	41
1C977-25-12	19	3/4	-12	19.1	M36x2	76.6	30.6	46
1C977-30-12	19	3/4	-12	19.1	M42x2	83	37	50
1C977-25-16	25	1	-16	25.4	M36x2	89	35	46
1C977-30-16	25	1	-16	25.4	M42x2	89	35	50
1C977-30-20	31	1 1/4	-20	31.8	M42x2	102	39	50
1C977-38-20	31	1 1/4	-20	31.8	M52x2	100	36	60
1C977-38-24	38	1 1/2	-24	38.1	M52x2	106	39	60

Fittings with standard O-ring seals can be used for temperatures from -40 °C up to +105 °C.  
O-rings see section Eb. Special O-rings are available on request.

## OC Female Metric 24° – Swivel Heavy Series with O-Ring 45° Elbow

ISO 12151-2 – SWE 45°-S – DKOS 45°

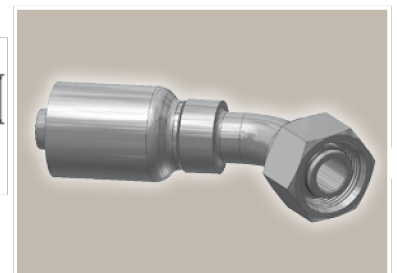
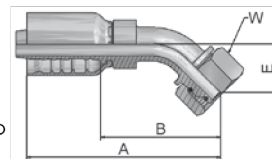

Part Number	Hose I.D.				Thread metric	A mm	B mm	E mm	W mm
	DN	Inch	Size	mm					
10C77-16-8	12	1/2	-8	12.7	M24x1.5	83	49	24	30
10C77-12-10	16	5/8	-10	15.9	M20x1.5	104	65	25	24
10C77-16-10	16	5/8	-10	15.9	M24x1.5	111	64	24	30
10C77-20-10	16	5/8	-10	15.9	M30x2	107	68	28	36
10C77-20-12	19	3/4	-12	19.1	M30x2	120	74	30	36
10C77-25-12-SW41	19	3/4	-12	19.1	M36x2	119	73	29	41
10C77-25-12	19	3/4	-12	19.1	M36x2	119	73	29	46
10C77-30-12	19	3/4	-12	19.1	M42x2	121	75	30	50
10C77-25-16	25	1	-16	25.4	M36x2	142	88	33	46
10C77-30-16	25	1	-16	25.4	M42x2	142	88	33	50
10C77-30-20	31	1 1/4	-20	31.8	M42x2	155	91	34	50
10C77-38-20	31	1 1/4	-20	31.8	M52x2	161	97	37	60
10C77-38-24	38	1 1/2	-24	38.1	M52x2	195	128	49	60

Fittings with standard O-ring seals can be used for temperatures from -40 °C up to +105 °C.  
O-rings see section Eb. Special O-rings are available on request.

Approved **fitting series** for hose types:

77	387	387ST	387TC	487	487ST	487TC	size -20 up to -32	787	787TC	797	797TC
----	-----	-------	-------	-----	-------	-------	--------------------	-----	-------	-----	-------

# 1C Female Metric 24° – Swivel Heavy Series with O-Ring 90° Elbow

ISO 12151-2-SWE-S – DKOS 90°

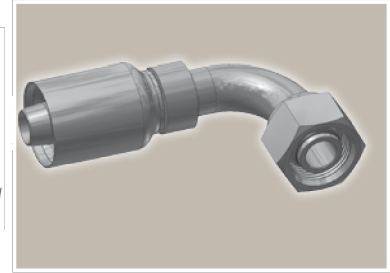
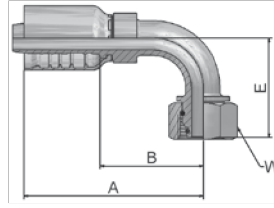

Part Number	Hose I.D.				Thread metric	A mm	B mm	E mm	W mm
	DN	Inch	Size	mm					
11C77-16-8	12	1/2	-8	12.7	M24x1.5	77	42	45	30
11C77-16-10	16	5/8	-10	15.9	M24x1.5	92	53	45	30
11C77-20-10	16	5/8	-10	15.9	M30x2	92	53	53	36
11C77-20-10-STB60	16	5/8	-10	15.9	M30x2	115	76	37	36
11C77-20-12	19	3/4	-12	19.1	M30x2	108	62	60	36
11C77-20-12-STB60	19	3/4	-12	19.1	M30x2	134	88	41	36
11C77-25-12	19	3/4	-12	19.1	M36x2	108	62	58.5	46
11C77-25-12-STB60	19	3/4	-12	19.1	M36x2	133	87	40	46
11C77-25-12-SW41	19	3/4	-12	19.1	M36x2	108	62	59	41
11C77-30-12	19	3/4	-12	19.1	M42x2	108	62	61	50
11C77-25-16	25	1	-16	25.4	M36x2	131	77	69	46
11C77-30-16	25	1	-16	25.4	M42x2	131	77	69	50
11C77-30-16-SL120	25	1	-16	25.4	M42x2	131	77	120	50
11C77-30-20	31	1 1/4	-20	31.8	M42x2	145	82	73	50
11C77-38-20	31	1 1/4	-20	31.8	M52x2	151	87	78	60
11C77-38-24	38	1 1/2	-24	38.1	M52x2	179	112	101	60

Fittings with standard O-ring seals can be used for temperatures from -40 °C up to +105 °C. O-rings see section Eb. Special O-rings are available on request.

# D2 Male Metric 24° – Rigid Heavy Series – Straight

ISO 12151-2-S-S – CES

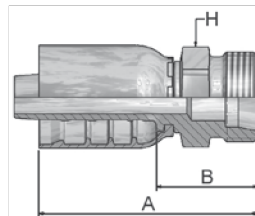

Part Number	Hose I.D.				Thread metric	A mm	B mm	H mm
	DN	Inch	Size	mm				
1D277-16-8	12	1/2	-8	12.7	M24x1.5	64	30	24
1D277-16-10	16	5/8	-10	15.9	M24x1.5	69	30	24
1D277-20-10	16	5/8	-10	15.9	M30x2	72	34	30
1D277-20-12	19	3/4	-12	19.1	M30x2	84	38	30
1D277-25-12	19	3/4	-12	19.1	M36x2	86	40	36
1D277-25-16	25	1	-16	25.4	M36x2	96	42	36
1D277-30-16	25	1	-16	25.4	M42x2	99	45	46
1D277-30-20	31	1 1/4	-20	31.8	M42x2	110	47	46
1D277-38-20	31	1 1/4	-20	31.8	M52x2	114	51	55
1D277-38-24	38	1 1/2	-24	38.1	M52x2	120	53	55

Approved **fitting series** for hose types:

**77** | 387 | 387ST | 387TC | 487 | 487ST | 487TC | size -20 up to -32 | 787 | 787TC | 797 | 797TC

## 92 Female BSP Parallel Pipe Swivel – Straight (60° Cone)

BS5200-A – DKR

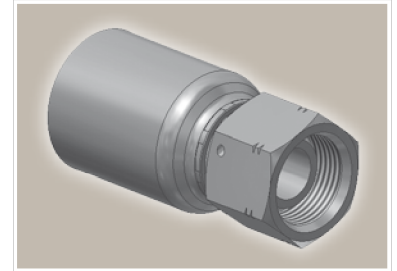
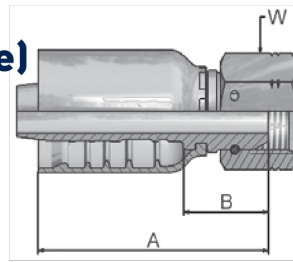

Part Number	Hose I.D.				Thread BSP	A mm	B mm	W mm
	DN	Inch	Size	mm				
19277-8-8	12	1/2	-8	12.7	1/2x14	57	23	27
19277-12-12	19	3/4	-12	19.1	3/4x14	73	27	32
19277-16-12	19	3/4	-12	19.1	1x11	85	39	41
19277-12-16	25	1	-16	25.4	3/4x14	83	29	32
19277-16-16	25	1	-16	25.4	1x11	91	37	41
19277-20-20	31	1 1/4	-20	31.8	1 1/4x11	98	34	50

## B1 Female BSP Parallel Pipe Swivel 45° Elbow (60° Cone)

BS 5200-D – DKR 45°

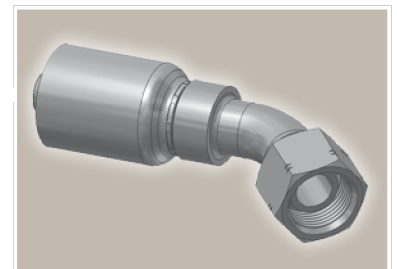
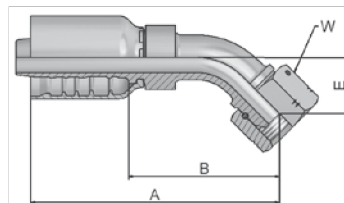

Part Number	Hose I.D.				Thread BSP	A mm	B mm	E mm	W mm
	DN	Inch	Size	mm					
1B177-8-8	12	1/2	-8	12.7	1/2x14	84	49	20	27
1B177-12-12	19	3/4	-12	19.1	3/4x14	116	70	26	32
1B177-16-12	19	3/4	-12	19.1	1x11	124	78	34	41
1B177-16-16	25	1	-16	25.4	1x11	145	91	36	41

Approved **fitting series** for hose types:

77	387	387ST	387TC	487	487ST	487TC	size -20 up to -32	787	787TC	797	797TC
----	-----	-------	-------	-----	-------	-------	--------------------	-----	-------	-----	-------

## B2 Female BSP Parallel Pipe Swivel 90° Elbow (60° Cone)

BS 5200-B – DKR 90°

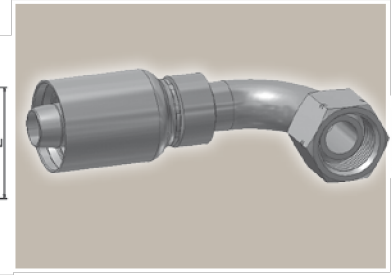
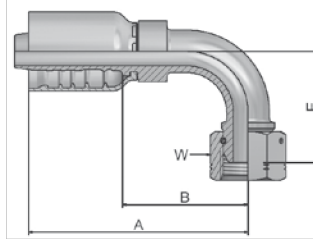

Part Number	Hose I.D.				Thread BSP	A mm	B mm	E mm	W mm
	DN	Inch	Size	mm					
1B277-8-8	12	1/2	-8	12.7	1/2x14	76	41	40	27
1B277-12-12	19	3/4	-12	19.1	3/4x14	108	62	55	32
1B277-16-16	25	1	-16	25.4	1x11	131	77	74	41

## EA BSP Swivel Female with O-Ring (60° Cone)

BS 5200 – ISO 12151-6 – DKOR

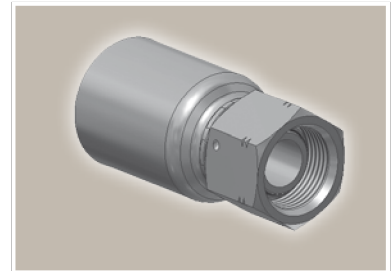
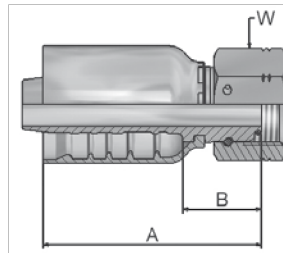

Part Number	Hose I.D.				Thread BSP	A mm	B mm	W mm
	DN	Inch	Size	mm				
1EA77-8-8	12	1/2	-8	12.7	1/2x14	58	23	27
1EA77-10-10	16	5/8	-10	15.9	5/8x14	62	23	30
1EA77-12-10	16	5/8	-10	15.9	3/4x14	63	24	32
1EA77-12-12	19	3/4	-12	19.1	3/4x14	72	26	32
1EA77-16-12	19	3/4	-12	19.1	1x11	82	36	41
1EA77-12-16	25	1	-16	25.4	3/4x14	83	29	32
1EA77-16-16	25	1	-16	25.4	1x11	90	36	41
1EA77-20-20	31	1 1/4	-20	31.8	1 1/4x11	96	33	50
1EA77-24-24	38	1 1/2	-24	38.1	1 1/2	103	36	55
1EA77-32-32	51	2	-32	50.8	2	118	40	70

Fittings with standard O-ring seals can be used for temperatures from -40 °C up to +105 °C.  
O-rings see section Eb. Special O-rings are available on request.

Approved **fitting series** for hose types:

**77** | 387 | 387ST | 387TC | 487 | 487ST | 487TC | size -20 up to -32 | 787 | 787TC | 797 | 797TC



## EB BSP Swivel Female with O-Ring 45° Elbow (60° Cone)

BS 5200 – ISO 12151-6 – DKOR 45°

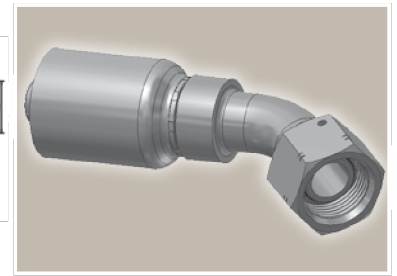
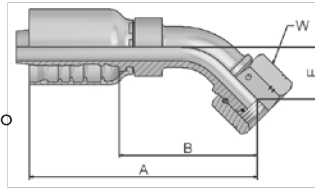

Part Number	Hose I.D.				Thread BSP	A mm	B mm	E mm	W mm
	DN	Inch	Size	mm					
1EB77-8-8	12	1/2	-8	12.7	1/2x14	80	45	20	27
1EB77-10-10	16	5/8	-10	15.9	5/8x14	101	62	22	30
1EB77-12-10	16	5/8	-10	15.9	3/4x14	103	64	24	32
1EB77-12-12	19	3/4	-12	19.1	3/4x14	117	71	27	32
1EB77-16-12	19	3/4	-12	19.1	1x11	120	74	29	41
1EB77-16-16	25	1	-16	25.4	1x11	144	90	35	41
1EB77-20-20	31	1 1/4	-20	31.8	1 1/4x11	159	95	35	50
1EB77-24-24	38	1 1/2	-24	38.1	1 1/2	196	129	50	55
1EB77-32-32	51	2	-32	50.8	2	255	178	86	70

Fittings with standard O-ring seals can be used for temperatures from -40 °C up to +105 °C.  
O-rings see section Eb. Special O-rings are available on request.

## EC BSP Swivel Female with O-Ring 90° Elbow (60° Cone)

BS 5200 – ISO 12151-6 – DKOR 90°

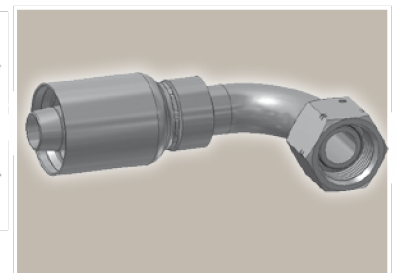
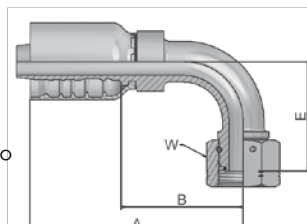

Part Number	Hose I.D.				Thread BSP	A mm	B mm	E mm	W mm
	DN	Inch	Size	mm					
1EC77-8-8	12	1/2	-8	12.7	1/2x14	76	41	40	27
1EC77-10-10	16	5/8	-10	15.9	5/8x14	92	53	44	30
1EC77-12-10	16	5/8	-10	15.9	3/4x14	92	53	47	32
1EC77-12-12	19	3/4	-12	19.1	3/4x14	108	62	55	32
1EC77-16-12	19	3/4	-12	19.1	1x11	108	62	59	41
1EC77-16-16	25	1	-16	25.4	1x11	131	77	72	41
1EC77-20-20	31	1 1/4	-20	31.8	1 1/4x11	151	87	75	50
1EC77-24-24	38	1 1/2	-24	38.1	1 1/2	179	112	103	55
1EC77-32-32	51	2	-32	50.8	2	236	159	147	70

Fittings with standard O-ring seals can be used for temperatures from -40 °C up to +105 °C.  
O-rings see section Eb. Special O-rings are available on request.

Approved **fitting series** for hose types:

77	387	387ST	387TC	487	487ST	487TC	size -20 up to -32	787	787TC	797	797TC
----	-----	-------	-------	-----	-------	-------	--------------------	-----	-------	-----	-------

**D9** **Male BSP Parallel Pipe  
Rigid – Straight (60° Cone)**  
BS5200 – AGR

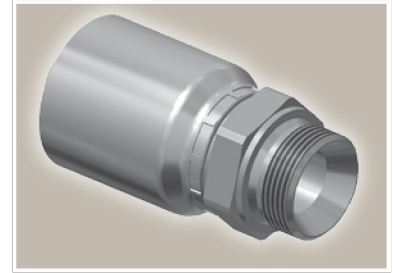
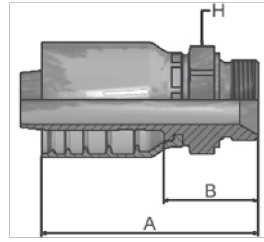

Part Number	Hose I.D.				Thread BSP	A mm	B mm	H mm
	DN	Inch	Size	mm				
1D977-8-8	12	1/2	-8	12.7	1/2x14	68	33	27
1D977-10-10	16	5/8	-10	15.9	5/8x14	74	36	30
1D977-12-12	19	3/4	-12	19.1	3/4x14	87	41	32
1D977-16-12	19	3/4	-12	19.1	1x11	91	45	41
1D977-16-16	25	1	-16	25.4	1x11	91	45	41
1D977-20-16	25	1	-16	25.4	1 1/4x11	103	49	50
1D977-20-20	31	1 1/4	-20	31.8	1 1/4x11	113	50	50
1D977-24-24	38	1 1/2	-24	38.1	1 1/2x11	124	57	55

Approved **fitting series** for hose types:

77	387	387ST	387TC	487	487ST	487TC	size -20 up to -32	787	787TC	797	797TC
----	-----	-------	-------	-----	-------	-------	--------------------	-----	-------	-----	-------

# 01

## Male NPTF Pipe Rigid – Straight

SAE J476A/ J516 – AGN

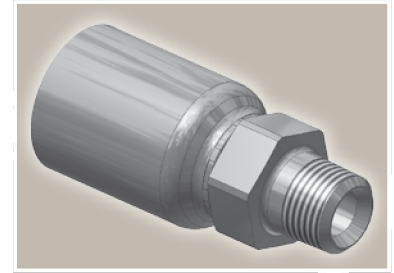
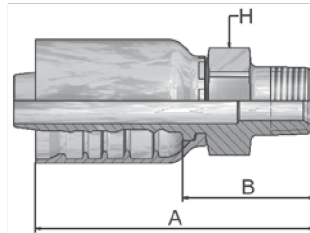

Part Number	Hose I.D.				Thread NPTF	A mm	B mm	H mm
	DN	Inch	Size	mm				
10177-8-8	12	1/2	-8	12.7	1/2x14	69	35	22
10177-8-12	19	3/4	-12	19.1	1/2x14	87	41	30
10177-12-12	19	3/4	-12	19.1	3/4x14	87	41	30
10177-16-16	25	1	-16	25.4	1x11 1/2	103	49	36
10177-20-20	31	1 1/4	-20	31.8	1 1/4x11	116	53	46
10177-24-24	38	1 1/2	-24	38.1	1 1/2x11	124	57	50
10177-32-32	51	2	-32	50.8	2x11	143	66	65

All sizes of 10177 fittings are rated at 35,0 MPa working pressure.

# 03

## Male JIC 37° – Rigid Straight

ISO12151-5-S – AGJ

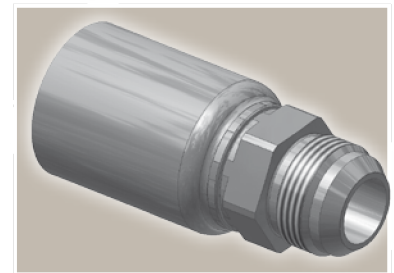
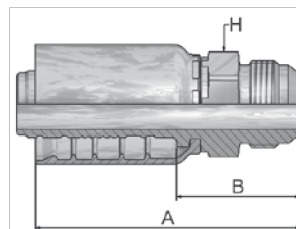

Part Number	Hose I.D.				Thread UNF	A mm	B mm	H mm
	DN	Inch	Size	mm				
10377-8-8	12	1/2	-8	12.7	3/4x16	66.45	32	22
10377-10-8	12	1/2	-8	12.7	7/8x14	69	34	24
10377-12-8	12	1/2	-8	12.7	1 1/16x12	77	42	27
10377-10-10	16	5/8	-10	15.9	7/8x14	76	38	24
10377-12-10	16	5/8	-10	15.9	1 1/16x12	82	43	30
10377-10-12	19	3/4	-12	19.1	7/8x14	87	41	30
10377-12-12	19	3/4	-12	19.1	1 1/16x12	89	43	30
10377-16-12	19	3/4	-12	19.1	1 5/16x12	92	46	36
10377-16-16	25	1	-16	25.4	1 5/16x12	101.4	47	36
10377-20-16	25	1	-16	25.4	1 5/8x12	110	56	50
10377-20-20	31	1 1/4	-20	31.8	1 5/8x12	118	55	50
10377-32-32	51	2	-32	50.8	2 1/2x12	148	71	65

All sizes of 10377 fittings are rated at 35,0 MPa working pressure.

Approved **fitting series** for hose types:

**77** | 387 | 387ST | 387TC | 487 | 487ST | 487TC | size -20 up to -32 | 787 | 787TC | 797 | 797TC

# 06 Female JIC 37° – Swivel Straight

ISO12151-5-SWS – DKJ

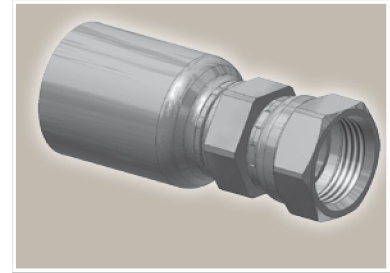
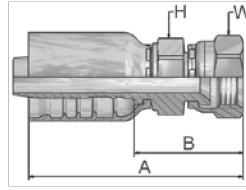

Part Number	Hose I.D.				Thread UNF	A mm	B mm	H mm	W mm
	DN	Inch	Size	mm					
10677-8-8	12	1/2	-8	12.7	3/4x16	71	37	22	22
10677-10-8	12	1/2	-8	12.7	7/8x14	74	39	22	27
10677-12-8	12	1/2	-8	12.7	1 1/16x12	80	46	30	32
10677-10-10	16	5/8	-10	15.9	7/8x14	81	42	24	27
10677-12-10	16	5/8	-10	15.9	1 1/16x12	84	45	30	32
10677-10-12	19	3/4	-12	19.1	7/8x14	92	46	30	27
10677-12-12	19	3/4	-12	19.1	1 1/16x12	94	48	30	32
10677-14-12	19	3/4	-12	19.1	1 3/16x12	99	53	36	36
10677-16-12	19	3/4	-12	19.1	1 5/16x12	99	53	36	41
10677-12-16	25	1	-16	25.4	1 1/16x12	102	48	36	32
10677-16-16	25	1	-16	25.4	1 5/16x12	106	52	36	41
10677-20-16	25	1	-16	25.4	1 5/8x12	109	55	41	50
10677-16-20	31	1 1/4	-20	31.8	1 5/16x12	120	57	46	41
10677-20-20	31	1 1/4	-20	31.8	1 5/8 12	124	60	46	50
10677-24-20	31	1 1/4	-20	31.8	1 7/8x12	108	44	50	60
10677-24-24	38	1 1/2	-24	38.1	1 7/8x12	136	69	50	60
10677-32-32	51	2	-32	50.8	2 1/2x12	160	83	65	75

All sizes of 10677 fittings are rated at 35,0 MPa working pressure.

Approved **fitting series** for hose types:

77 387 387ST 387TC 487 487ST 487TC size -20 up to -32 787 787TC 797 797TC

### 37 Female JIC 37° – Swivel 45° Elbow

ISO 12151-5-SWE 45° – DKJ 45°

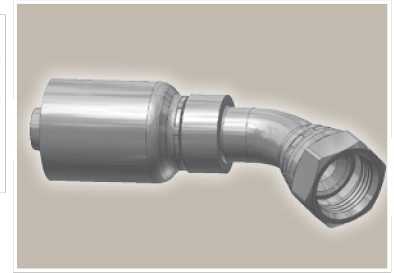
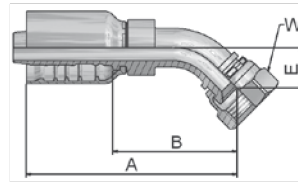

Part Number	Hose I.D.				Thread UNF	A mm	B mm	E mm	W mm
	DN	Inch	Size	mm					
13777-8-8	12	1/2	-8	12.7	3/4x16	73	38	15	22
13777-10-8	12	1/2	-8	12.7	7/8x14	76	41	16	27
13777-12-8	12	1/2	-8	12.7	1 1/16x12	79	44	21	32
13777-10-10	16	5/8	-10	15.9	7/8x14	93	54	16	27
13777-12-10	16	5/8	-10	15.9	1 1/16x12	100	61	21	32
13777-10-12	19	3/4	-12	19.1	7/8x14	102	56	16	27
13777-12-12	19	3/4	-12	19.1	1 1/16x12	111	65	21	32
13777-16-12	19	3/4	-12	19.1	1 5/16x12	114	68	24	41
13777-16-16	25	1	-16	25.4	1 5/16x12	133	79	24	41
13777-20-20	31	1 1/4	-20	31.8	1 5/8x12	153	90	32	50
13777-24-24	38	1 1/2	-24	38.1	1 7/8x12	201	134	58	60
13777-32-32	51	2	-32	50.8	2 1/2x12	258	181	72	75

All sizes of 13777 fittings are rated at 35,0 MPa working pressure.

### 39 Female JIC 37° – Swivel 90° Elbow

ISO 12151-5-SWES – DKJ 90°

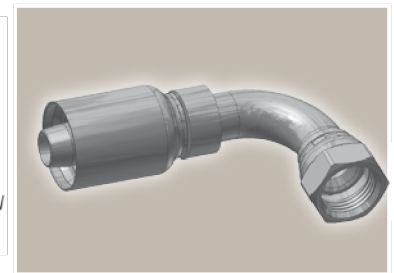
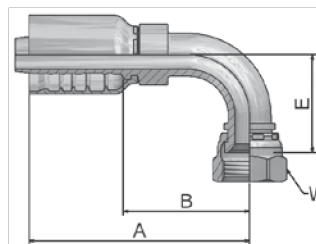

Part Number	Hose I.D.				Thread UNF	A mm	B mm	E mm	W mm
	DN	Inch	Size	mm					
13977-8-8	12	1/2	-8	12.7	3/4x16	71	36	29	22
13977-10-8	12	1/2	-8	12.7	7/8x14	76	41	32	27
13977-12-8	12	1/2	-8	12.7	1 1/16x12	76	41	48	32
13977-10-10	16	5/8	-10	15.9	7/8x14	88	50	33	27
13977-12-10	16	5/8	-10	15.9	1 1/16x12	92	53	48	32
13977-10-12	19	3/4	-12	19.1	7/8x14	97	51	33	27
13977-12-12	19	3/4	-12	19.1	1 1/16x12	108	62	48	32
13977-16-12	19	3/4	-12	19.1	1 5/16x12	108	62	56	41
13977-16-16	25	1	-16	25.4	1 5/16x12	131	77	74	41
13977-20-20	31	1 1/4	-20	31.8	1 5/8x12	148	84	78	50
13977-24-24	38	1 1/2	-24	38.1	1 7/8x12	175	108	102	60
13977-32-32	51	2	-32	50.8	2 1/2x12	236	159	152	75

All sizes of 13977 fittings are rated at 35,0 MPa working pressure.

Approved fitting series for hose types:

77	387	387ST	387TC	487	487ST	487TC	size -20 up to -32	787	787TC	797	797TC
----	-----	-------	-------	-----	-------	-------	--------------------	-----	-------	-----	-------

# 15/4A ISO 6162-1 Flange Straight

ISO 12151-3-S-L – SFL  
(35.0 MPa/ 5000 psi)

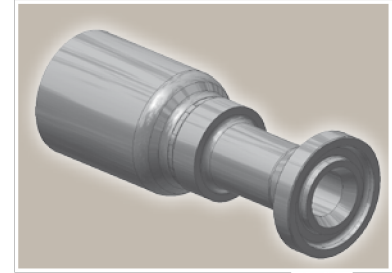
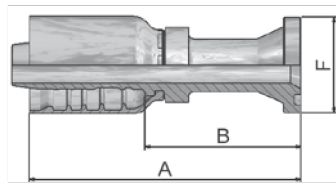

Part Number	Hose I.D.				Flange Inch	A mm	B mm	F mm
	DN	Inch	Size	mm				
11577-8-8	12	1/2	-8	12.7	1/2	90	55	30
11577-12-8	12	1/2	-8	12.7	3/4	67	33	38
11577-10-10	16	5/8	-10	15.9	5/8	99	60	34
11577-12-10	16	5/8	-10	15.9	3/4	75	36	38
11577-12-12	19	3/4	-12	19.1	3/4	107	62	38
11577-16-12	19	3/4	-12	19.1	1	88	42	45
11577-16-16	25	1	-16	25.4	1	119	65	45
14A77-20-16	25	1	-16	25.4	1 1/4	90	36	51
11577-16-20	31	1 1/4	-20	31.8	1	130	66	45
14A77-20-20	31	1 1/4	-20	31.8	1 1/4	138	74	51
14A77-24-20	31	1 1/4	-20	31.8	1 1/2	100	37	60
14A77-20-24	38	1 1/2	-24	38.1	1 1/4	146	79	51
14A77-24-24	38	1 1/2	-24	38.1	1 1/2	140	73	60
14A77-32-24	38	1 1/2	-24	38.1	2	117	50	71
14A77-32-32	51	2	-32	50.8	2	163	86	71

SAE flange halves see in section Eb.

Fittings with standard O-ring seals can be used for temperatures from -40 °C up to +105 °C.  
O-rings see section Eb. Special O-rings are available on request.

Approved **fitting series** for hose types:

77	387	387ST	387TC	487	487ST	487TC	size -20 up to -32	787	787TC	797	797TC
----	-----	-------	-------	-----	-------	-------	--------------------	-----	-------	-----	-------

# 17/4F ISO 6162-1 Flange 45° Elbow

ISO 12151-3 – E45S – L – SFL 45°  
(35.0 MPa/ 5000 psi)

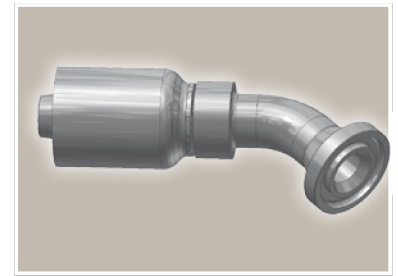
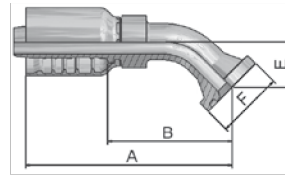

Part Number	Hose I.D.				Flange Inch	A mm	B mm	E mm	F mm
	DN	Inch	Size	mm					
11777-8-8	12	1/2	-8	12.7	1/2	79	45	20	30
11777-12-8	12	1/2	-8	12.7	3/4	81	47	22	38
11777-10-10	16	5/8	-10	15.9	5/8	103	64	24	34
11777-12-12	19	3/4	-12	19.1	3/4	116	70	26	38
11777-16-12	19	3/4	-12	19.1	1	116	70	26	45
11777-16-16	25	1	-16	25.4	1	141	87	32	45
14F77-20-16	25	1	-16	25.4	1 1/4	141	87	32	51
14F77-20-20	31	1 1/4	-20	31.8	1 1/4	162	99	38	51
14F77-24-20	31	1 1/4	-20	31.8	1 1/2	162	99	38	60
14F77-24-24	38	1 1/2	-24	38.1	1 1/2	187	120	44	60
14F77-32-24	38	1 1/2	-24	38.1	2	182	115	44	71
14F77-32-32	51	2	-32	50.8	2	211	134	56	71

SAE flange halves see in section Eb.

Fittings with standard O-ring seals can be used for temperatures from -40 °C up to +105 °C.  
O-rings see section Eb. Special O-rings are available on request.



Approved **fitting series** for hose types:

77	387	387ST	387TC	487	487ST	487TC	size -20 up to -32	787	787TC	797	797TC
----	-----	-------	-------	-----	-------	-------	--------------------	-----	-------	-----	-------

# 19/4N ISO 6162-1 Flange 90° Elbow

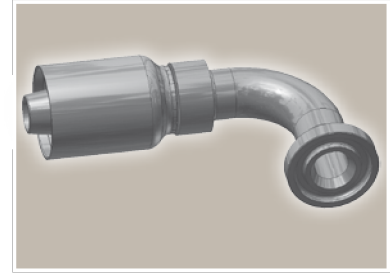
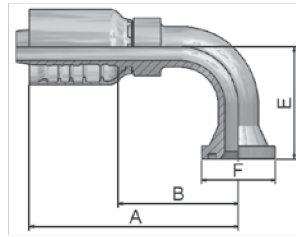
ISO 12151-3-E-L – SFL 90°  
(35.0 MPa/ 5000 psi)



Part Number	 Hose I.D.				 Flange	A mm	B mm	E mm	F mm
	DN	Inch	Size	mm	Inch				
11977-8-8	12	1/2	-8	12.7	1/2	76	41	41	30
11977-12-8	12	1/2	-8	12.7	3/4	80	45	42	38
11977-10-10	16	5/8	-10	15.9	5/8	92	53	53	34
11977-12-12	19	3/4	-12	19.1	3/4	108	62	58	38
11977-16-12	19	3/4	-12	19.1	1	108	62	58	45
11977-16-16	25	1	-16	25.4	1	131	77	70	45
14N77-20-16	25	1	-16	25.4	1 1/4	131	77	69	51
11977-16-20	31	1 1/4	-20	31.8	1	151	87	90	45
14N77-20-20	31	1 1/4	-20	31.8	1 1/4	151	87	90	51
14N77-24-20	31	1 1/4	-20	31.8	1 1/2	151	87	90	60
14N77-24-24	38	1 1/2	-24	38.1	1 1/2	175	108	104	60
14N77-32-24	38	1 1/2	-24	38.1	2	170	103	104	71
14N77-32-32	51	2	-32	50.8	2	206	129	138	71

SAE flange halves see in section Eb.

Fittings with standard O-ring seals can be used for temperatures from -40 °C up to +105 °C.  
O-rings see section Eb. Special O-rings are available on request.

Approved **fitting series** for hose types:



<b>77</b>	387	387ST	387TC	487	487ST	487TC	size -20 up to -32	787	787TC	797	797TC
-----------	-----	-------	-------	-----	-------	-------	--------------------	-----	-------	-----	-------

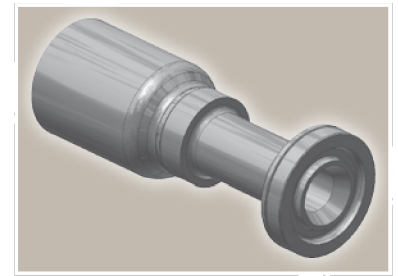
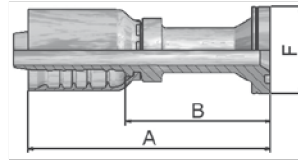

## 6A ISO 6162-2 Flange Straight

ISO 12151-3-S-S – SFS  
(42.0 MPa/ 6000 psi)



Part Number	 Hose I.D.				 Flange	A mm	B mm	F mm
	DN	Inch	Size	mm	Inch			
16A77-8-8	12	1/2	-8	12.7	1/2	89.85	55.2	32
16A77-12-8	12	1/2	-8	12.7	3/4	69.4	34.75	41
16A77-12-10	16	5/8	-10	15.9	3/4	75	36	41
16A77-16-10	16	5/8	-10	15.9	1	80	41	48
16A77-8-12	19	3/4	-12	19.1	1/2	106	60	32
16A77-12-12	19	3/4	-12	19.1	3/4	114.2	68.2	41
16A77-16-12	19	3/4	-12	19.1	1	88.2	42	48
16A77-20-12	19	3/4	-12	19.1	1 1/4	93	47	54
16A77-12-16	25	1	-16	25.4	3/4	126	72	41
16A77-16-16	25	1	-16	25.4	1	113	59	48
16A77-20-16	25	1	-16	25.4	1 1/4	103	49	54
16A77-16-20	31	1 1/4	-20	31.8	1	145	82	48
16A77-20-20	31	1 1/4	-20	31.8	1 1/4	146	82	54
16A77-24-20	31	1 1/4	-20	31.8	1 1/2	118	55	64
16A77-20-24	38	1 1/2	-24	38.1	1 1/4	154	87	54
16A77-24-24	38	1 1/2	-24	38.1	1 1/2	162	96	64
16A77-32-24	38	1 1/2	-24	38.1	2	133	66	79
16A77-32-32	51	2	-32	50.8	2	182	105	79

SAE flange halves see in section Eb.

Fittings with standard O-ring seals can be used for temperatures from -40 °C up to +105 °C.

O-rings see section Eb. Special O-rings are available on request.

Approved **fitting series** for hose types:

**77** | 387 | 387ST | 387TC | 487 | 487ST | 487TC | size -20 up to -32 | 787 | 787TC | 797 | 797TC

## 6E ISO 6162-2 Flange 30° Elbow

SFS 30°  
(42.0 MPa/ 6000 psi)

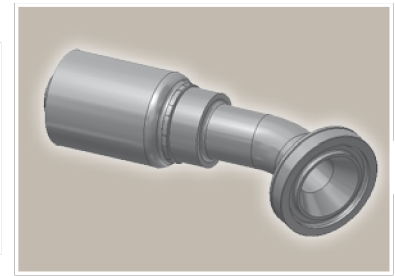
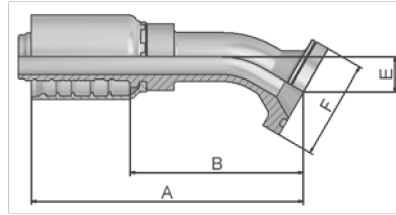

Part Number	Hose I.D.				Flange Inch	A mm	B mm	E mm	F mm
	DN	Inch	Size	mm					
16E77-12-12	19	3/4	-12	19.1	3/4	121	75	16	41
16E77-16-12	19	3/4	-12	19.1	1	122	76	16	48
16E77-16-16	25	1	-16	25.4	1	136	82	19	48
16E77-20-16	25	1	-16	25.4	1 1/4	149	95	19	54
16E77-20-20	31	1 1/4	-20	31.8	1 1/4	167	104	22	54
16E77-24-24	38	1 1/2	-24	38.1	1 1/2	190	123	30	64
16E77-32-32	51	2	-32	50.8	2	223	145	32	79

SAE flange halves see in section Eb.

Fittings with standard O-ring seals can be used for temperatures from -40 °C up to +105 °C.  
O-rings see section Eb. Special O-rings are available on request.

## 6F ISO 6162-2 Flange 45° Elbow – Heavy Series

ISO 12151-3 – E45-S – SFS 45°  
(42.0 MPa/ 6000 psi)

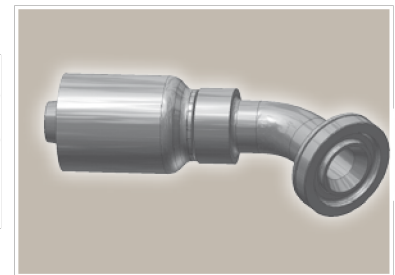
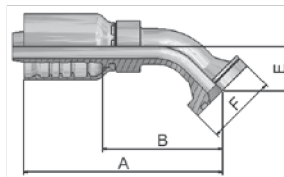

Part Number	Hose I.D.				Flange Inch	A mm	B mm	E mm	F mm
	DN	Inch	Size	mm					
16F77-8-8	12	1/2	-8	12.7	1/2	79	44	19	32
16F77-12-8	12	1/2	-8	12.7	3/4	85.8	51	26	41
16F77-8-10	16	5/8	-10	15.9	1/2	105	66	26	32
16F77-12-10	16	5/8	-10	15.9	3/4	104	66	26	41
16F77-16-10	16	5/8	-10	15.9	1	105	66	26	48
16F77-12-12	19	3/4	-12	19.1	3/4	116.2	70	26	41
16F77-16-12	19	3/4	-12	19.1	1	116	70	26	48
16F77-12-16	25	1	-16	25.4	3/4	132	78	32	41
16F77-16-16	25	1	-16	25.4	1	141	87	32	48
16F77-20-16	25	1	-16	25.4	1 1/4	142	88	32	54
16F77-16-20	31	1 1/4	-20	31.8	1	159	95	38	48
16F77-20-20	31	1 1/4	-20	31.8	1 1/4	162	99	38	54
16F77-24-20	31	1 1/4	-20	31.8	1 1/2	162	99	38	64
16F77-20-24	38	1 1/2	-24	38.1	1 1/4	179	112	44	54
16F77-24-24	38	1 1/2	-24	38.1	1 1/2	182	115	44	64
16F77-32-24	38	1 1/2	-24	38.1	2	187	120	44	79
16F77-32-32	51	2	-32	50.8	2	211	134	56	79

SAE flange halves see in section Eb.

Fittings with standard O-ring seals can be used for temperatures from -40 °C up to +105 °C.  
O-rings see section Eb. Special O-rings are available on request.

Approved **fitting series** for hose types:



**77** | 387 | 387ST | 387TC | 487 | 487ST | 487TC | size -20 up to -32 | 787 | 787TC | 797 | 797TC

# 6N

## ISO 6162-2 Flange 90° Elbow

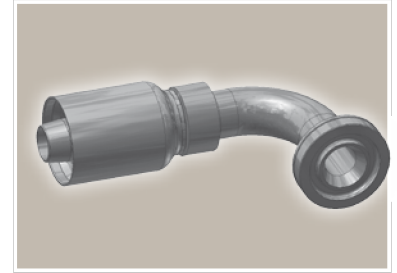
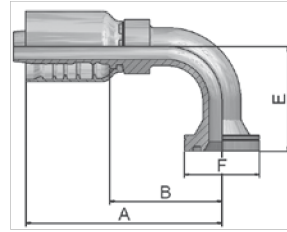
ISO 12151-3 – E-S – SFS 90°  
(42.0 MPa/ 6000 psi)



Part Number	 Hose I.D.				 Flange	A	B	E	F
	DN	Inch	Size	mm					
16N77-8-8	12	1/2	-8	12.7	1/2	77.05	42	41	32
16N77-12-8	12	1/2	-8	12.7	3/4	81.05	47	45	41
16N77-8-10	16	5/8	-10	15.9	1/2	92	53	54	32
16N77-12-10	16	5/8	-10	15.9	3/4	92	53	54	41
16N77-16-10	16	5/8	-10	15.9	1	92	53	54	48
16N77-12-12	19	3/4	-12	19.1	3/4	108.2	62	58	41
16N77-16-12	19	3/4	-12	19.1	1	108	62	58	48
16N77-20-12	19	3/4	-12	19.1	1 1/4	108	62	63	54
16N77-12-16	25	1	-16	25.4	3/4	118	64	70	41
16N77-16-16	25	1	-16	25.4	1	131	77	70	48
16N77-20-16	25	1	-16	25.4	1 1/4	135	81	70	54
16N77-16-20	31	1 1/4	-20	31.8	1	145	82	90	48
16N77-20-20	31	1 1/4	-20	31.8	1 1/4	151	87	90	54
16N77-24-20	31	1 1/4	-20	31.8	1 1/2	151	87	90	64
16N77-20-24	38	1 1/2	-24	38.1	1 1/4	156	89	104	54
16N77-24-24	38	1 1/2	-24	38.1	1 1/2	175	108	104	64
16N77-32-24	38	1 1/2	-24	38.1	2	175	108	104	79
16N77-32-32	51	2	-32	50.8	2	206	129	138	79

SAE flange halves see in section Eb.

Fittings with standard O-ring seals can be used for temperatures from -40 °C up to +105 °C.

O-rings see section Eb. Special O-rings are available on request.

Approved **fitting series** for hose types:

<b>77</b>	387	387ST	387TC	487	487ST	487TC	size -20 up to -32	787	787TC	797	797TC
-----------	-----	-------	-------	-----	-------	-------	--------------------	-----	-------	-----	-------

## X5 Flange – Straight

Full flange system for  
ISO 6162-1 or ISO 6162-2

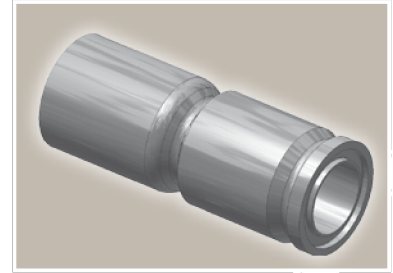
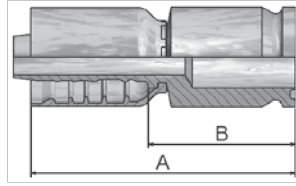



Part Number	 Hose I.D.				A mm	B mm
	DN	Inch	Size	mm		
1X577-12-12	19	3/4	-12	19.1	103	57
1X577-16-12	19	3/4	-12	19.1	103.2	57
1X577-16-16	25	1	-16	25.4	113	59
1X577-20-16	25	1	-16	25.4	113	59
1X577-24-16	25	1	-16	25.4	113	59
1X577-20-20	31	1 1/4	-20	31.8	124	57
1X577-24-24	38	1 1/2	-24	38.1	129	62
1X577-32-32	51	2	-32	50.8	154	77

Full flange system see Eb-2.

## X7 Flange – 45° Elbow

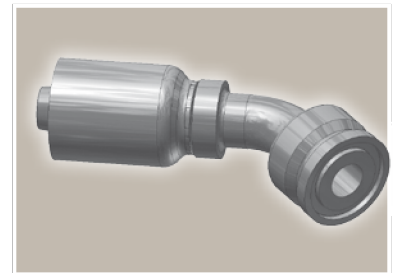
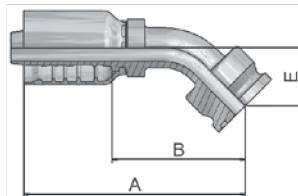
Full flange system for  
ISO 6162-1 or ISO 6162-2



Part Number	 Hose I.D.				A mm	B mm	E mm
	DN	Inch	Size	mm			
1X777-12-12	19	3/4	-12	19.1	118.4	72.6	28.5
1X777-16-12	19	3/4	-12	19.1	118.4	72.4	28.5
1X777-16-16	25	1	-16	25.4	141	87	32
1X777-20-16	25	1	-16	25.4	147	93	38
1X777-16-20	31	1 1/4	-20	31.8	146	82	38
1X777-20-20	31	1 1/4	-20	31.8	159	96	38
1X777-24-20	31	1 1/4	-20	31.8	165	102	44
1X777-24-24	38	1 1/2	-24	38.1	183	116	45

Full flange system see Eb-2.

Approved **fitting series** for hose types:

**77** | 387 | 387ST | 387TC | 487 | 487ST | 487TC | size -20 up to -32 | 787 | 787TC | 797 | 797TC

## X9 Flange – 90° Elbow

Full flange system for  
ISO 6162-1 or ISO 6162-2

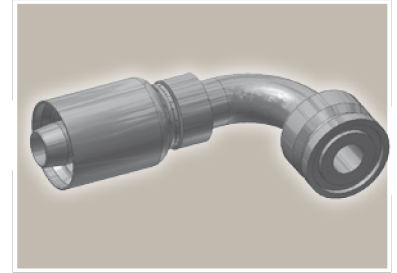
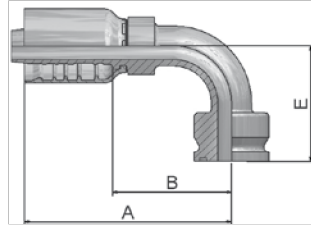



Part Number	 Hose I.D.				A mm	B mm	E mm
	DN	Inch	Size	mm			
1X977-8-8	12	1/2	-8	12.7	81	45	43
1X977-12-12	19	3/4	-12	19.1	107.5	61.7	60.5
1X977-16-12	19	3/4	-12	19.1	107.6	61.8	60.5
1X977-12-16	25	1	-16	25.4	110	56	70
1X977-16-16	25	1	-16	25.4	131	77	70
1X977-20-16	25	1	-16	25.4	131	77	70
1X977-16-20	31	1 1/4	-20	31.8	130	67	90
1X977-20-20	31	1 1/4	-20	31.8	148	84	90
1X977-24-20	31	1 1/4	-20	31.8	148	84	90
1X977-24-24	38	1 1/2	-24	38.1	170	103	104
1X977-32-32	51	2	-32	50.8	221	144	138

Full flange system see Eb-2.

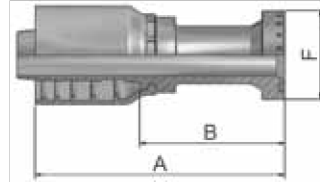
## XA Caterpillar® Flange Straight





Part Number	 Hose I.D.				 Flange	A mm	B mm	F mm
	DN	Inch	Size	mm				
1XA77-12-12	19	3/4	-12	19.1	3/4	114	68	41
1XA77-16-12	19	3/4	-12	19.1	3/4	88	42	48
1XA77-16-16	25	1	-16	25.4	1	141	87	48
1XA77-20-16	25	1	-16	25.4	1	104	50	54
1XA77-20-20	31	1 1/4	-20	31.8	1 1/4	152	88	54
1XA77-24-20	31	1 1/4	-20	31.8	1 1/2	121	57	64
1XA77-24-24	38	1 1/2	-24	38.1	1 1/2	176	109	64
1XA77-32-24	38	1 1/2	-24	38.1	2	133	66	79
1XA77-32-32	51	2	-32	50.8	2	192	115	79

Approved **fitting series** for hose types:

**77** | 387 | 387ST | 387TC | 487 | 487ST | 487TC | size -20 up to -32 | 787 | 787TC | 797 | 797TC

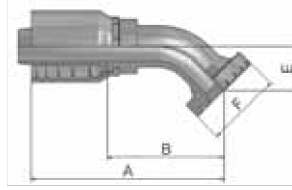

## XF Caterpillar® Flange 45° Elbow

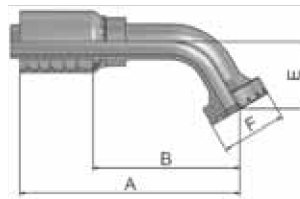

Part Number	 Hose I.D.				 Flange	A mm	B mm	E mm	F mm
	DN	Inch	Size	mm	Inch				
1XF77-12-12	19	3/4	-12	19.1	3/4	122	76	31	41
1XF77-16-16	25	1	-16	25.4	1	145	91	36	48
1XF77-20-20	31	1 1/4	-20	31.8	1 1/4	161	98	37	54
1XF77-24-20	31	1 1/4	-20	31.8	1 1/2	161	98	37	64

## XG Caterpillar® Flange 60° Elbow



Part Number	 Hose I.D.				 Flange	A mm	B mm	E mm	F mm
	DN	Inch	Size	mm	Inch				
1XG77-12-12	19	3/4	-12	19.1	3/4	137	91	42	41
1XG77-16-16	25	1	-16	25.4	1	163	109	50	48
1XG77-20-20	31	1 1/4	-20	31.8	1 1/4	200	136	51	54

Approved **fitting series** for hose types:

**77** 387 387ST 387TC 487 487ST 487TC size -20 up to -32 | 787 787TC 797 797TC

## XN Caterpillar® Flange 90° Elbow

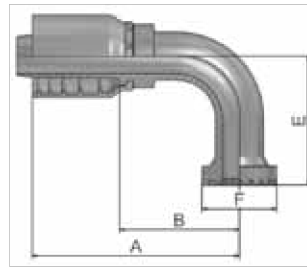

Part Number	Hose I.D.				Flange Inch	A mm	B mm	E mm	F mm
	DN	Inch	Size	mm					
1XN77-12-12	19	3/4	-12	19.1	3/4	108	62	63	41
1XN77-16-12	19	3/4	-12	19.1	1	108	62	63	48
1XN77-16-16	25	1	-16	25.4	1	131	77	74	48
1XN77-20-16	25	1	-16	25.4	1 1/4	120	66	74	54
1XN77-20-20	31	1 1/4	-20	31.8	1 1/4	151	87	94	54
1XN77-24-20	31	1 1/4	-20	31.8	1 1/2	151	87	77	64
1XN77-24-24	38	1 1/2	-24	38.1	1 1/2	160	103	106	79
1XN77-32-24	38	1 1/2	-24	38.1	2	169	103	106	79

## K5 Komatsu® Flange Straight

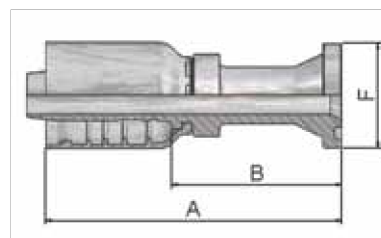



Part Number	Hose I.D.				A mm	B mm
	DN	Inch	Size	mm		
1K577-16-16	25	1	-16	25.4	119	65

Approved **fitting series** for hose types:

77 387 387ST 387TC 487 487ST 487TC size -20 up to -32 787 787TC 797 797TC

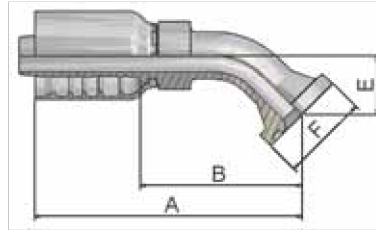
## K7 Komatsu® Flange 45° Elbow



Part Number	 Hose I.D.				A mm	B mm	E mm
	DN	Inch	Size	mm			
1K777-12-12	19	3/4	-12	19.1	116	70	26
1K777-16-16	25	1	-16	25.4	143	89	32
1K777-20-20	31	1 1/4	-20	31.8	159	96	38

## K9 Komatsu® Flange 90° Elbow

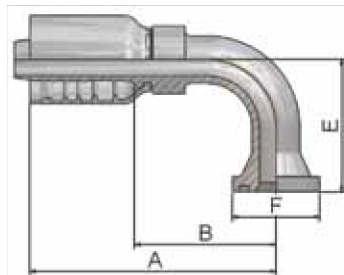

Part Number	 Hose I.D.				A mm	B mm	E mm
	DN	Inch	Size	mm			
1K977-12-12	19	3/4	-12	19.1	108	62	58
1K977-16-16	25	1	-16	25.4	127	73	70
1K977-20-20	31	1 1/4	-20	31.8	148	84	90

Approved **fitting series** for hose types:

**77** 387 387ST 387TC 487 487ST 487TC size -20 up to -32 | 787 787TC 797 797TC



# JC

## Female ORFS Swivel – Straight Short

ISO 12151-1 – SWSA  
SAE J516 – ORFS

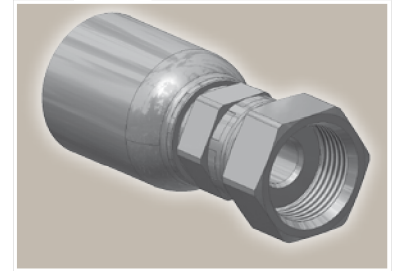
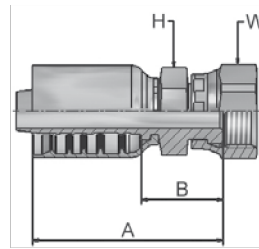

Part Number	Hose I.D.				Thread UNF	A mm	B mm	H mm	W mm
	DN	Inch	Size	mm					
1JC77-8-8	12	1/2	-8	12.7	13/16x16	60	25	22	24
1JC77-10-8	12	1/2	-8	12.7	1x14	65	31	24	30
1JC77-12-8	12	1/2	-8	12.7	1 3/16x12	64	29	30	36
1JC77-10-10	16	5/8	-10	15.9	1x14	70	31	24	30
1JC77-12-10	16	5/8	-10	15.9	13/16x16	69	30	30	36
1JC77-10-12	19	3/4	-12	19.1	1x14	79	33	30	30
1JC77-12-12	19	3/4	-12	19.1	1 3/16x12	78.5	32.5	30	36
1JC77-16-12	19	3/4	-12	19.1	1 7/16x12	81	35.3	36	41
1JC77-12-16	25	1	-16	25.4	1 3/16x12	92	38	36	36
1JC77-16-16	25	1	-16	25.4	1 7/16x12	91	37.1	36	41
1JC77-20-16	25	1	-16	25.4	1 11/16x12	90	36	41	50
1JC77-20-20	31	1 1/4	-20	31.8	1 11/16x12	107	44	46	50
1JC77-24-24	38	1 1/2	-24	38.1	2x12	109	43	50	60
1JC77-32-32	51	2	-32	50.8	2 1/2x12	143	66	65	75

All sizes of 1JC77 fittings are rated at 35,0 MPa working pressure.

# J7

## Female ORFS – Swivel 45° Elbow

ISO 12151-1 – SWE 45°  
SAE J516 – ORFS 45°

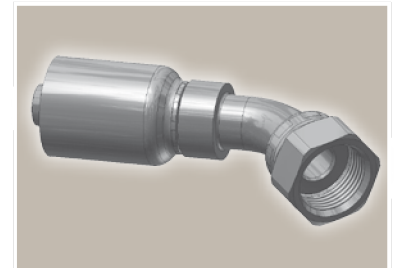
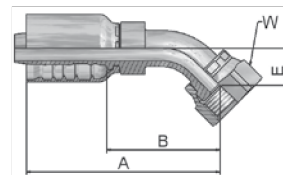

Part Number	Hose I.D.				Thread UNF	A mm	B mm	E mm	W mm
	DN	Inch	Size	mm					
1J777-8-8	12	1/2	-8	12.7	13/16x16	72.7	38	15	24
1J777-10-10	16	5/8	-10	15.9	1x14	93	54	16	30
1J777-12-10	16	5/8	-10	15.9	1 3/16x12	98	59	21	36
1J777-12-12	19	3/4	-12	19.1	1 3/16x12	111	65	21	36
1J777-16-12	19	3/4	-12	19.1	1 7/16x12	114	68	24	41
1J777-16-16	25	1	-16	25.4	1 7/16x12	133	79	24	41
1J777-20-20	31	1 1/4	-20	31.8	1 11/16x12	145	81	25	50
1J777-24-20	31	1 1/4	-20	31.8	2x12	148	84	27	60
1J777-24-24	38	1 1/2	-24	38.1	2x12	176	109	42	60

Approved fitting series for hose types:

77	387	387ST	387TC	487	487ST	487TC	size -20 up to -32	787	787TC	797	797TC
----	-----	-------	-------	-----	-------	-------	--------------------	-----	-------	-----	-------

## J9 Female ORFS – Swivel 90° Elbow – Short Drop

ISO 12151-1 – SWES  
SAE J516 – ORFS 90°

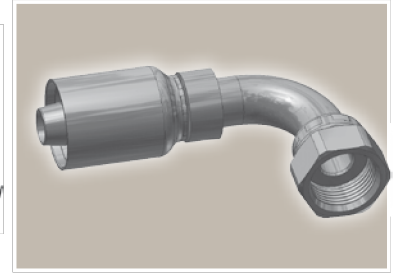
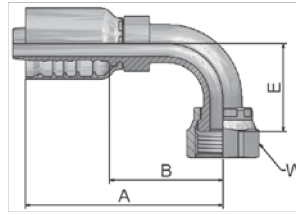

Part Number	Hose I.D.				Thread UNF	A mm	B mm	E mm	W mm
	DN	Inch	Size	mm					
1J977-8-8	12	1/2	-8	12.7	13/16x16	70.65	36	29	24
1J977-10-10	16	5/8	-10	15.9	1x14	97	50	32	30
1J977-12-10	16	5/8	-10	15.9	1 3/16x12	89	50	48	36
1J977-10-12	19	3/4	-12	19.1	1x14	97	51	32	30
1J977-12-12	19	3/4	-12	19.1	1 3/16x12	108	62	48	36
1J977-16-12	19	3/4	-12	19.1	1 7/16x12	108	62	56	41
1J977-16-16	25	1	-16	25.4	1 7/16x12	131	77	56	41
1J977-20-20	31	1 1/4	-20	31.8	1 11/16x12	146	82	64	50
1J977-24-24	38	1 1/2	-24	38.1	2x12	163	96	69	60

## J1 Female ORFS – Swivel 90° Elbow – Long Drop

ISO 12151-1 – SWEL  
SAE J 516 – ORFS 90° L

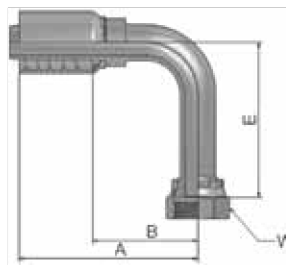

Part Number	Hose I.D.				Thread UNF	A mm	B mm	E mm	W mm
	DN	Inch	Size	mm					
1J177-12-12	19	3/4	-12	19.1	1 3/16x12	108	62	96	36
1J177-16-16	25	1	-16	25.4	1 7/16x12	131	77	114	41

Approved **fitting series** for hose types:

**77** | 387 | 387ST | 387TC | 487 | 487ST | 487TC | size -20 up to -32 | 787 | 787TC | 797 | 797TC

**JM**

**ORFS Male**

ISO 12151-1-S – SAE J516

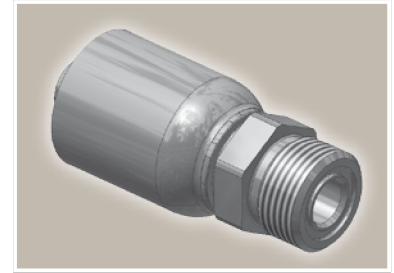
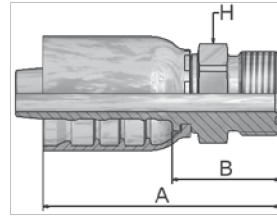

Part Number	Hose I.D.				Thread UNF	A mm	B mm	H mm
	DN	Inch	Size	mm				
1JM77-8-8	12	1/2	-8	12.7	13/16x16	62.5	27.85	22
1JM77-12-8	12	1/2	-8	12.7	1 3/16x12	69.6	34.95	32
1JM77-10-10	16	5/8	-10	15.9	1x14	71.65	33	27
1JM77-12-10	16	5/8	-10	15.9	1 3/16x12	76	37	30
1JM77-12-12	19	3/4	-12	19.1	1 3/16x12	83	37	32
1JM77-16-12	19	3/4	-12	19.1	1 7/16x12	83.6	37.8	41
1JM77-16-16	25	1	-16	25.4	1 7/16x12	96	40.9	41
1JM77-20-16	25	1	-16	25.4	1 11/16x12	93	39.2	46
1JM77-20-20	31	1 1/4	-20	31.8	1 11/16x12	110	46	50
1JM77-24-20	31	1 1/4	-20	31.8	2 12	116	52	60



JM fittings are supplied without O-ring.  
Find O-rings in section E. Special O-rings are available on request.

Approved **fitting series** for hose types:

<b>77</b>	387	387ST	387TC	487	487ST	487TC	size -20 up to -32	787	787TC	797	797TC
-----------	-----	-------	-------	-----	-------	-------	--------------------	-----	-------	-----	-------

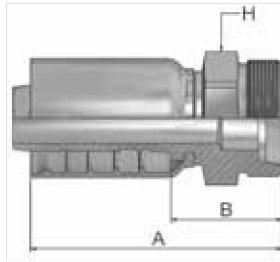
**FG** Male French Gas Series  
Rigid – Straight (24° Cone)



Part Number	 Hose I.D.				 Thread metric	A mm	B mm	 H mm
	DN	Inch	Size	mm				
1FG77-27-12	19	3/4	-12	19.1	M36x1.5	82	36	36
1FG77-33-16	25	1	-16	25.4	M45x1.5	97	43	46

Approved **fitting series** for hose types:

<b>77</b>	387	387ST	387TC	487	487ST	487TC	size -20 up to -32	787	787TC	797	797TC
-----------	-----	-------	-------	-----	-------	-------	--------------------	-----	-------	-----	-------

## Large range of special hose fittings for the MRO market



The demand for special hose fittings is part of our everyday business.

In order to meet this demand with the authority expected, the Hose Products Division Europe has extended its standard offer with special hose fittings such as an extra drop length, etc.

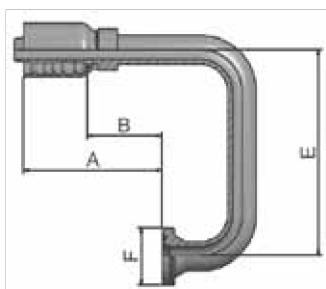
The following is an overview of our special hose fitting selection:



Further special hose fittings are available on request.

Part Number	Description			A mm	B mm	E mm	F mm
		Hose I.D. Size	Flange Inch				
11977-12-12-SL100	SAE 5000 psi 90° elbow - drop length 100 mm	-12	3/4	108	62	100	38
11977-12-12-SL150	SAE 5000 psi 90° elbow - drop length 150 mm	-12	3/4	108	62	150	38
11977-16-12-SL100	SAE 5000 psi 90° elbow - drop length 100 mm	-12	1	108	62	100	45
11977-16-12-SL150	SAE 5000 psi 90° elbow - drop length 150 mm	-12	1	108	62	150	45
11977-16-16-SL150	SAE 5000 psi 90° elbow - drop length 150 mm	-16	1	131	77	150	45
14N77-24-24-SL150	SAE 5000 psi 90° elbow - drop length 150 mm	-24	1 1/2	175	108	150	60
16A77-20-20-RL186	SAE 6000 psi - straight - Special	-20	1 1/4	175	112		54
16F77-12-16-STB10	SAE 6000 psi - 10° elbow	-16	3/4	143	89	6	41
16F77-20-16-RL110	SAE 6000 psi - 45° elbow - Special	-16	1 1/4	164	110	32	54
16N77-12-12-SL100	SAE 6000 psi 90° elbow - drop length 100 mm	-12	3/4	108	62	100	41
16N77-12-12-SL230	SAE 6000 psi 90° elbow - drop length 230 mm	-12	3/4	108	62	230	41
16N77-12-12-SL72	SAE 6000 psi 90° elbow - drop length 72 mm	-12	3/4	108	62	72	41
16N77-12-12-SL85	SAE 6000 psi 90° elbow - drop length 85 mm	-12	3/4	108	62	85	41
16N77-12-12-STB115	SAE 6000 psi - 115° elbow	-12	3/4	116	70	72	41
16N77-12-12-STB180	SAE 6000 psi - 180° elbow	-12	3/4	101	55	150	41
16N77-12-16-SL55	SAE 6000 psi 90° elbow - drop length 85 mm	-16	3/4	118	64	55	41
16N77-12-16-SL95	SAE 6000 psi 90° elbow - drop length 95 mm	-16	3/4	118	64	95	41
16N77-16-16-SL100	SAE 6000 psi 90° elbow - drop length 100 mm	-16	1	131	77	100	48
16N77-16-16-SL110	SAE 6000 psi 90° elbow - drop length 110 mm	-16	1	131	77	110	48
16N77-16-16-SL120	SAE 6000 psi 90° elbow - drop length 120 mm	-16	1	131	77	120	48
16N77-16-16-SL150	SAE 6000 psi 90° elbow - drop length 150 mm	-16	1	131	77	150	48
16N77-16-16-SL175	SAE 6000 psi 90° elbow - drop length 175 mm	-16	1	135	81	175	48
16N77-16-16-STB120	SAE 6000 psi 120° elbow	-16	1	110	56	85	48
16N77-16-16-STB63-SL75	SAE 6000 psi 63° elbow - drop length 75 mm	-16	1	167	113	75	48
16N77-20-16-SL120	SAE 6000 psi 90° elbow - drop length 120 mm	-16	1 1/4	135	81	120	54
16N77-20-16-SL130	SAE 6000 psi 90° elbow - drop length 130 mm	-16	1 1/4	135	81	130	54
16N77-20-16-STB110-SL150	SAE 6000 psi 110° elbow - drop length 150 mm	-16	1 1/4	128	74	150	54
16N77-20-16-STB70-SL70	SAE 6000 psi 70° elbow - drop length 70 mm	-16	1 1/4	157	103	70	54
16N77-20-20-SL115-RL220	SAE 6000 psi 90° elbow - drop length 220 mm	-20	1 1/4	220	156	115	54
16N77-20-20-SL120	SAE 6000 psi 90° elbow - drop length 120 mm	-20	1 1/4	151	87	120	54
16N77-20-20-SL150-RL150	SAE 6000 psi 90° elbow - drop length 150 mm	-20	1 1/4	238	175	150	54
16N77-20-20-SL150-RL220	SAE 6000 psi 90° elbow - drop length 150 mm	-20	1 1/4	220	156	150	54
16N77-20-20-SL195-RL320	SAE 6000 psi 90° elbow - drop length 195 mm	-20	1 1/4	320	256	195	54
16N77-20-20-SL230-RL250	SAE 6000 psi 90° elbow - drop length 230 mm	-20	1 1/4	338	275	230	54
16N77-20-20-SL230-RL320	SAE 6000 psi 90° elbow - drop length 230 mm	-20	1 1/4	320	256	230	54
16377-16-16	SAE 6000 psi 135° elbow	-16	1	122	68	88	48
16377-20-20	SAE 6000 psi 135° elbow	-20	1 1/4	132	69	109	54
16377-24-24	SAE 6000 psi 135° elbow	-24	1 1/2	124	57	129	64

Approved **fitting series** for hose types:

<b>77</b>	387	387ST	387TC	487	487ST	487TC	size -20 up to -32	787	787TC	797	797TC
-----------	-----	-------	-------	-----	-------	-------	--------------------	-----	-------	-----	-------

## Shell

Page De-1

**VS**

De-1



Interlock  
Outside Skive

## DIN – Metric

Page De-2 – De-5

**CA**

De-2

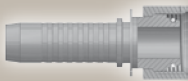

Female Metric 24°  
Light Series with O-Ring  
Swivel – Straight  
ISO 12151-2-SWS-L – DKOL

**CE**

De-2

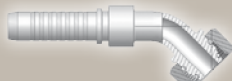

Female Metric 24°  
Light Series with O-Ring  
Swivel – 45° Elbow  
ISO 12151-2-SWE 45°-L – DKOL 45°

**CF**

De-3

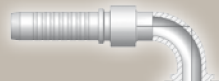

Female Metric 24°  
Light Series with O-Ring  
Swivel – 90° Elbow  
ISO 12151-2-SWE-L – DKOL 90°

**D0**

De-3

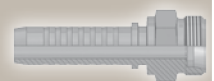

Male Metric 24°  
Light Series – Rigid  
Straight  
ISO 12151-2-S-L – CEL

**C9**

De-4

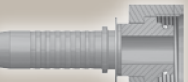

Female Metric 24° – Swivel  
Heavy Series with O-Ring  
Straight  
ISO 12151-2-SWS-S – DKOS

**OC**

De-4

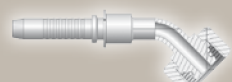

Female Metric 24° – Swivel  
Heavy Series with O-Ring  
45° Elbow  
ISO 12151-2 – SWE 45°-S – DKOS 45°

**1C**

De-5

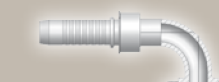

Female Metric 24° – Swivel  
Heavy Series with O-Ring  
90° Elbow  
ISO 12151-2-SWE-S – DKOS 90°

**D2**

De-5



Male Metric 24° – Rigid  
Heavy Series – Straight  
ISO 12151-2-S-S – CES

## BSP

Page De-6 – De-7

**92**

De-6

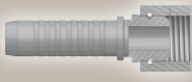

Female BSP Parallel Pipe  
Swivel – Straight (60° Cone)  
BS5200-A – DKR

**B1**

De-6

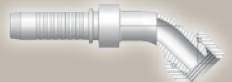

Female BSP Parallel Pipe  
Swivel  
45° Elbow (60° Cone)  
BS 5200-D – DKR 45°

**B2**

De-7

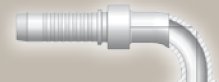

Female BSP Parallel Pipe  
Swivel  
90° Elbow (60° Cone)  
BS 5200-B – DKR 90°

**D9**

De-7

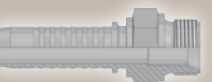

Male BSP Parallel Pipe  
Rigid – Straight (60° Cone)  
BS5200 – AGR

## SAE

Page De-8 – De-10

**01**

De-8



Male NPTF Pipe  
Rigid – Straight  
SAE J476A / J516 – AGN

**03**

De-8

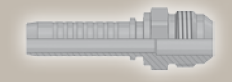

Male JIC 37° – Rigid  
Straight  
ISO12151-5-S – AGJ

**06/68**

De-9

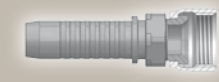

Female – JIC 37°  
SAE 45° Dual Flare  
Swivel – Straight  
ISO12151-5-SWS – DKJ

**37/3V**

De-9

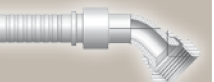

Female JIC 37°  
SAE 45° – Dual Flare  
Swivel Female 45° Elbow  
ISO 12151-5-SWE 45° – DKJ 45°

**39/3W**

De-10

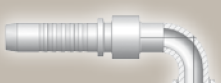

Female JIC 37°  
SAE 45° – Dual Flare  
Swivel Female 90° Elbow  
ISO 12151-5-SWES – DKJ 90°



## Flange

Page De-11 – De-13

<p><b>15</b></p> <p>De-11</p>  <p><b>ISO 6162-1 Flange Straight</b> ISO 12151-3-S-L – SFL (21.0 MPa/ 3000 psi)</p>	<p><b>17</b></p> <p>De-11</p>  <p><b>ISO 6162-1 Flange 45° Elbow</b> ISO 12151-3 – E45 – L – SFL 45° (21.0 MPa/ 3000 psi)</p>	<p><b>19</b></p> <p>De-12</p>  <p><b>ISO 6162-1 Flange 90° Elbow</b> ISO 12151-3 – E – L – SFL 90° (21.0 MPa/ 3000 psi)</p>
<p><b>6A</b></p> <p>De-12</p>  <p><b>ISO 6162-2 Flange Straight</b> ISO 12151-3-S-S – SFS (42.0 MPa/ 6000 psi)</p>	<p><b>6F</b></p> <p>De-13</p>  <p><b>ISO 6162-2 Flange 45° Elbow – Heavy Series</b> ISO 12151-3 – E45-S – SFS 45° (42.0 MPa/ 6000 psi)</p>	<p><b>6N</b></p> <p>De-13</p>  <p><b>ISO 6162-2 Flange 90° Elbow</b> ISO 12151-3 – E-S – SFS 90° (42.0 MPa/ 6000 psi)</p>

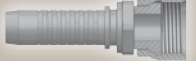

## ORFS

Page De-14 – De-15

<p><b>JC</b></p> <p>De-14</p>  <p><b>Female ORFS Swivel – Straight Short</b> ISO 12151-1 – SWSA SAE J516 – ORFS</p>	<p><b>J7</b></p> <p>De-14</p>  <p><b>Female ORFS – Swivel 45° Elbow</b> ISO 12151-1 – SWE 45° SAE J516 – ORFS 45°</p>	<p><b>J9</b></p> <p>De-15</p>  <p><b>Female ORFS – Swivel 90° Elbow – Short Drop</b> ISO 12151-1 – SWES SAE J516 – ORFS 90°</p>
--	--	---

## French Standard

Page De-16

<p><b>FG</b></p> <p>De-16</p>  <p><b>Male French Gas Series Rigid – Straight (24° Cone)</b></p>	<p><b>F4</b></p> <p>De-16</p>  <p><b>Female French Gas Series Swivel – Straight (Ball Nose)</b></p>
--	--





**VS**

**Interlock  
Outside Skive**

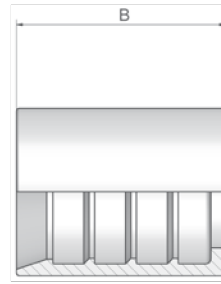

**Only for use with  
adjustable crimpers.**

Part Number	 Hose I.D.				B mm
	DN	Inch	Size	mm	
100VS-4	6	1/4	-4	6.4	38
100VS-6	10	3/8	-6	9.5	36
100VS-8	12	1/2	-8	12.7	41

VS Series

Approved **fitting series** for hose types:

<b>VS</b>	-4 to -8	H31	H31TC	H31ST
-----------	----------	-----	-------	-------

**CA** **Female Metric 24°  
Light Series with O-Ring  
Swivel – Straight**  
ISO 12151-2-SWS-L – DKOL

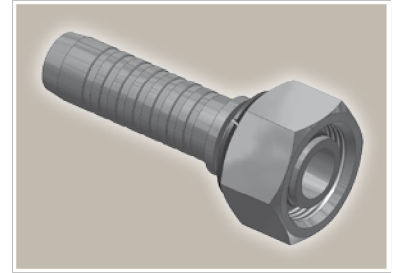
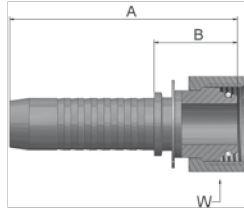

Part Number	Hose I.D.				Thread metric	Tube O.D. mm	A mm	B mm	W mm
	DN	Inch	Size	mm					
KCAVS-10-6	10	3/8	-6	9.5	M16x1.5	10	64	25	19
KCAVS-12-6	10	3/8	-6	9.5	M18x1.5	12	61	23	22
KCAVS-15-8	12	1/2	-8	12.7	M22x1.5	15	70	27	27

Fittings with standard O-ring seals can be used for temperatures from -40 °C up to +105 °C.  
O-rings see section Eb. Special O-rings are available on request.

**CE** **Female Metric 24°  
Light Series with O-Ring  
Swivel – 45° Elbow**  
ISO 12151-2-SWE 45°-L – DKOL 45°

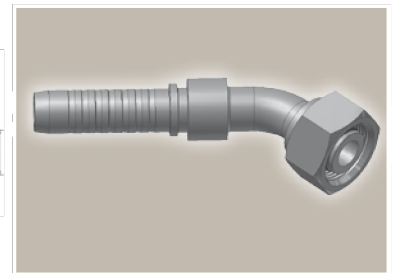
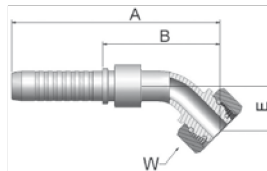

Part Number	Hose I.D.				Thread metric	Tube O.D. mm	A mm	B mm	E mm	W mm
	DN	Inch	Size	mm						
KCEVS-12-6	10	3/8	-6	9.5	M18x1.5	12	93	55	19	22
KCEVS-15-8	12	1/2	-8	12.7	M22x1.5	15	103	61	23	27

Fittings with standard O-ring seals can be used for temperatures from -40 °C up to +105 °C.  
O-rings see section Eb. Special O-rings are available on request.

Approved **fitting series** for hose types:

**VS** | -4 to -8 | H31 | H31TC | H31ST |

**CF** **Female Metric 24°  
Light Series with O-Ring  
Swivel – 90° Elbow**  
ISO 12151-2-SWE-L – DKOL 90°

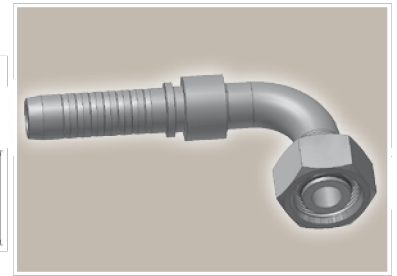
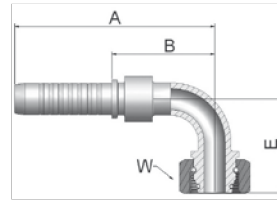

Part Number	Hose I.D.				Thread metric	Tube O.D. mm	A mm	B mm	E mm	W mm
	DN	Inch	Size	mm						
KCFVS-12-6	10	3/8	-6	9.5	M18x1.5	12	83	45	36	22
KCFVS-15-8	12	1/2	-8	12.7	M22x1.5	15	92	50	44	27

Fittings with standard O-ring seals can be used for temperatures from -40 °C up to +105 °C.  
O-rings see section Eb. Special O-rings are available on request.

**DO** **Male Metric 24°  
Light Series – Rigid  
Straight**  
ISO 12151-2-S-L – CEL

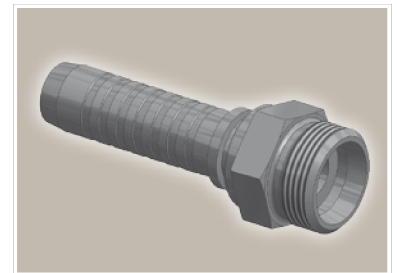
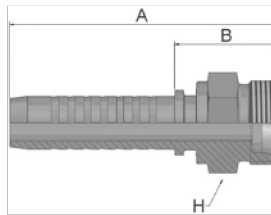

Part Number	Hose I.D.				Thread metric	Tube O.D. mm	A mm	B mm	H mm
	DN	Inch	Size	mm					
KDOVS-12-6	10	3/8	-6	9.5	M18x1.5	12	64	25	19
KDOVS-15-8	12	1/2	-8	12.7	M22x1.5	15	71	28	22

Approved **fitting series** for hose types:



## C9 Female Metric 24° – Swivel Heavy Series with O-Ring Straight

ISO 12151-2-SWS-S – DKOS

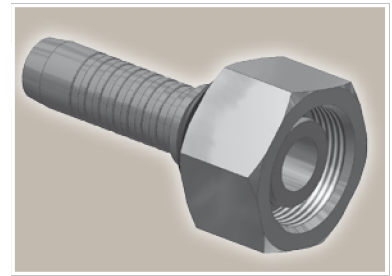
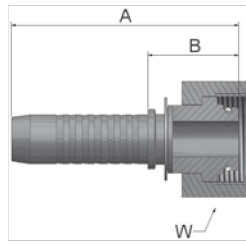

Part Number	Hose I.D.				Thread metric	Tube O.D. mm	A mm	B mm	W mm
	DN	Inch	Size	mm					
KC9VS-8-4	6	1/4	-4	6.4	M16x1.5	8	61	23	19
KC9VS-10-4	6	1/4	-4	6.4	M18x1.5	10	62	24	22
KC9VS-8-6	10	3/8	-6	9.5	M16x1.5	8	64	25	19
KC9VS-12-6	10	3/8	-6	9.5	M20x1.5	12	63	25	24
KC9VS-14-6	10	3/8	-6	9.5	M22x1.5	14	63	24	27
KC9VS-16-8	12	1/2	-8	12.7	M24x1.5	16	71	29	30
KC9VS-20-8	12	1/2	-8	12.7	M30x2	20	71	29	36

Fittings with standard O-ring seals can be used for temperatures from -40 °C up to +105 °C.  
O-rings see section Eb. Special O-rings are available on request.

## OC Female Metric 24° – Swivel Heavy Series with O-Ring 45° Elbow

ISO 12151-2 – SWE 45°-S – DKOS 45°

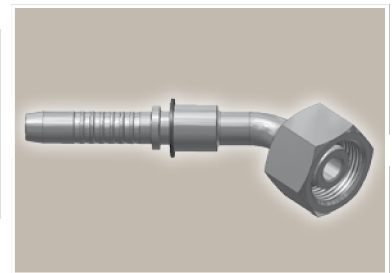
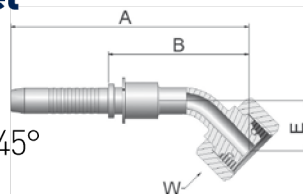

Part Number	Hose I.D.				Thread metric	Tube O.D. mm	A mm	B mm	E mm	W mm
	DN	Inch	Size	mm						
KOCVS-8-4	6	1/4	-4	6.4	M16x1.5	8	88	50	16	19
KOCVS-10-4	6	1/4	-4	6.4	M18x1.5	10	88	50	16	22
KOCVS-12-6	10	3/8	-6	9.5	M20x1.5	12	94	56	20	24
KOCVS-14-6	10	3/8	-6	9.5	M22x1.5	14	94	56	20	27
KOCVS-16-8	12	1/2	-8	12.7	M24x1.5	16	105	62	24	30

Fittings with standard O-ring seals can be used for temperatures from -40 °C up to +105 °C.  
O-rings see section Eb. Special O-rings are available on request.

Approved **fitting series** for hose types:

VS | -4 to -8 | H31 | H31TC | H31ST |

# 1C Female Metric 24° – Swivel Heavy Series with O-Ring 90° Elbow

ISO 12151-2-SWE-S – DKOS 90°

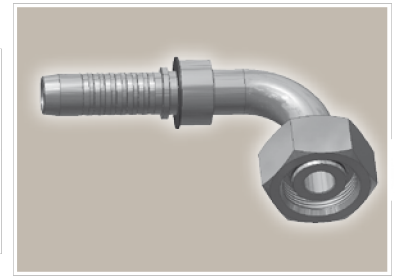
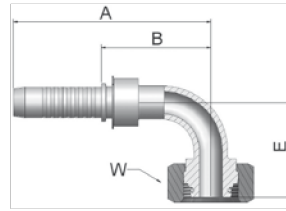

Part Number	Hose I.D.				Thread metric	Tube O.D. mm	A mm	B mm	E mm	W mm
	DN	Inch	Size	mm						
K1CVS-8-4	6	1/4	-4	6.4	M16x1.5	8	79	41	29	19
K1CVS-10-4	6	1/4	-4	6.4	M18x1.5	10	79	41	29	22
K1CVS-12-6	10	3/8	-6	9.5	M20x1.5	12	83	45	37	24
K1CVS-14-6	10	3/8	-6	9.5	M22x1.5	12	83	45	37	27
K1CVS-16-8	12	1/2	-8	12.7	M24x1.5	16	93	51	45	30

Fittings with standard O-ring seals can be used for temperatures from -40 °C up to +105 °C. O-rings see section Eb. Special O-rings are available on request.

# D2 Male Metric 24° – Rigid Heavy Series – Straight

ISO 12151-2-S-S – CES

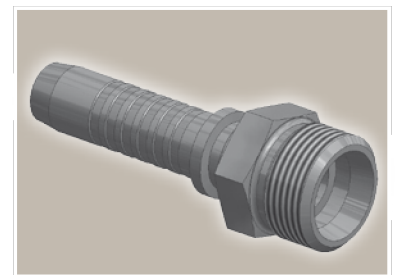
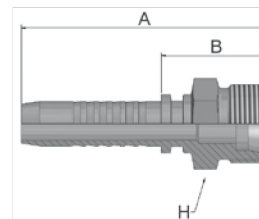

Part Number	Hose I.D.				Thread metric	Tube O.D. mm	A mm	B mm	H mm
	DN	Inch	Size	mm					
KD2VS-12-6	10	3/8	-6	9.5	M20x1.5	12	66	27	22
KD2VS-14-6	10	3/8	-6	9.5	M22x1.5	14	68	30	22
KD2VS-16-8	12	1/2	-8	12.7	M24x1.5	16	74	31	24

Approved **fitting series** for hose types:

**VS** | -4 to -8 | H31 | H31TC | H31ST |

## 92 Female BSP Parallel Pipe Swivel – Straight (60° Cone)

BS5200-A – DKR

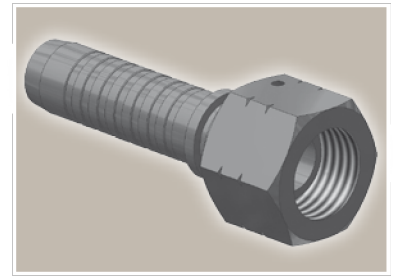
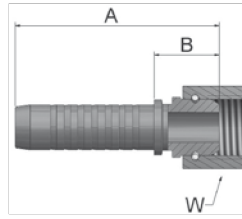

Part Number	Hose I.D.				Thread BSP	A mm	B mm	W mm
	DN	Inch	Size	mm				
K92VS-6-6	10	3/8	-6	9.5	3/8x19	60	22	22
K92VS-8-6	10	3/8	-6	9.5	1/2x14	62	23	27
K92VS-8-8	12	1/2	-8	12.7	1/2x14	67	24	27
K92VS-10-8	12	1/2	-8	12.7	5/8x14	65	23	30

## B1 Female BSP Parallel Pipe Swivel 45° Elbow (60° Cone)

BS 5200-D – DKR 45°

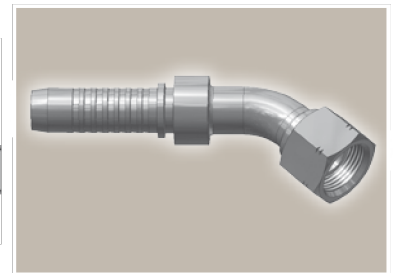
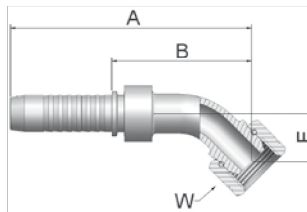

Part Number	Hose I.D.				Thread BSP	A mm	B mm	E mm	W mm
	DN	Inch	Size	mm					
KB1VS-6-6	10	3/8	-6	9.5	3/8x19	90	52	17	22
KB1VS-8-6	10	3/8	-6	9.5	1/2x14	91	53	17	27
KB1VS-8-8	12	1/2	-8	12.7	1/2x14	100	58	20	27
KB1VS-10-8	12	1/2	-8	12.7	5/8x14	99	57	19	30

Approved **fitting series** for hose types:

VS | -4 to -8 | H31 | H31TC | H31ST |

## B2 Female BSP Parallel Pipe Swivel 90° Elbow (60° Cone)

BS 5200-B – DKR 90°

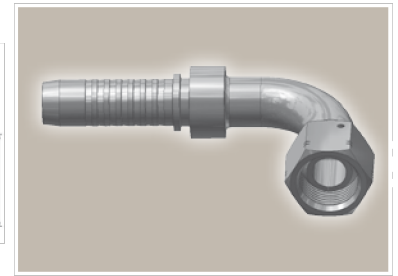
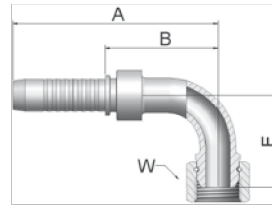

Part Number	Hose I.D.				Thread BSP	A mm	B mm	E mm	W mm
	DN	Inch	Size	mm					
KB2VS-6-6	10	3/8	-6	9.5	3/8x19	82	44	33	22
KB2VS-8-6	10	3/8	-6	9.5	1/2x14	83	45	36	27
KB2VS-8-8	12	1/2	-8	12.7	1/2x14	92	50	40	27
KB2VS-10-8	12	1/2	-8	12.7	5/8x14	92	50	38	30

## D9 Male BSP Parallel Pipe Rigid – Straight (60° Cone)

BS5200 – AGR

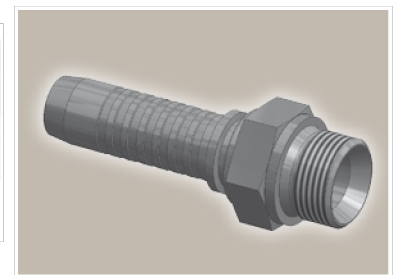
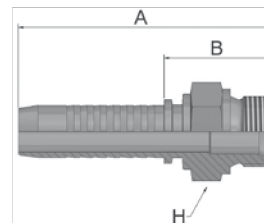

Part Number	Hose I.D.				Thread BSP	A mm	B mm	H mm
	DN	Inch	Size	mm				
KD9VS-4-4	6	1/4	-4	6.4	1/4x19	67	28	19
KD9VS-6-6	10	3/8	-6	9.5	3/8x19	71	33	22
KD9VS-8-8	12	1/2	-8	12.7	1/2x14	78	36	27

Approved **fitting series** for hose types:

**VS** | -4 to -8 | H31 | H31TC | H31ST |

# 01 Male NPTF Pipe Rigid – Straight

SAE J476A / J516 – AGN

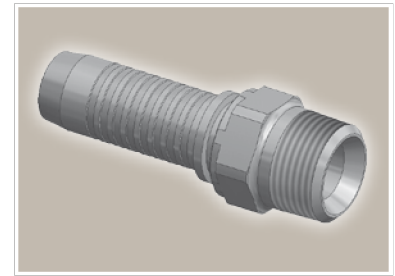
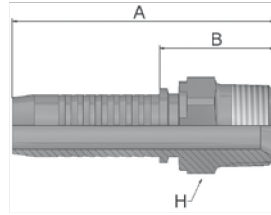

Part Number	Hose I.D.				Thread NPTF	A mm	B mm	H mm
	DN	Inch	Size	mm				
K01VS-6-6	10	3/8	-6	9.5	3/8x18	71	33	19
K01VS-8-8	12	1/2	-8	12.7	1/2x14	83	40	22

# 03 Male JIC 37° – Rigid Straight

ISO12151-5-S – AGJ

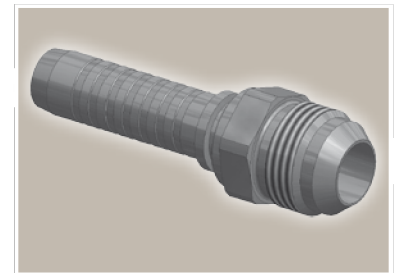
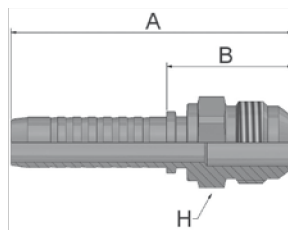

Part Number	Hose I.D.				Thread UNF	A mm	B mm	H mm
	DN	Inch	Size	mm				
K03VS-6-6	10	3/8	-6	9.5	9/16x18	71	32	19
K03VS-8-6	10	3/8	-6	9.5	3/4x16	69	31	22
K03VS-8-8	12	1/2	-8	12.7	3/4x16	79	36	22
K03VS-10-8	12	1/2	-8	12.7	7/8x14	77	35	24

Approved **fitting series** for hose types:

**VS** | -4 to -8 | H31 | H31TC | H31ST |



**06/68** Female – JIC 37°  
SAE 45° Dual Flare  
Swivel – Straight  
ISO12151-5-SWS – DKJ

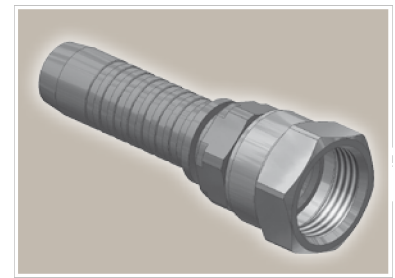
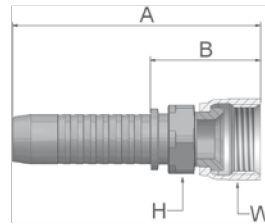

Part Number	Hose I.D.				Thread UNF	A mm	B mm	H mm	W mm
	DN	Inch	Size	mm					
K68VS-4-4	6	1/4	-4	6.4	7/16 20	66	28	14	17
K06VS-6-6	10	3/8	-6	9.5	9/16x18	69	31	17	19
K68VS-8-6	10	3/8	-6	9.5	3/4x16	74	35	17	22
K06VS-12-6	10	3/8	-6	9.5	1 1/16x12	78	40	27	32
K68VS-8-8	12	1/2	-8	12.7	3/4x16	77	35	22	22
K68VS-10-8	12	1/2	-8	12.7	7/8x14	83	41	22	27
K06VS-12-8	12	1/2	-8	12.7	1 1/16x12	83	41	27	32

**37/3V** Female JIC 37°  
SAE 45° – Dual Flare  
Swivel Female 45° Elbow  
ISO 12151-5-SWE 45° – DKJ 45°

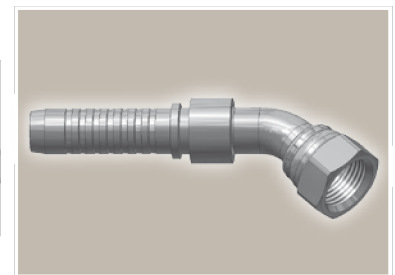
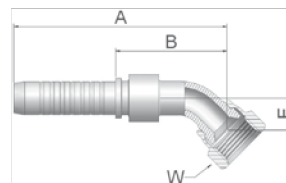





Part Number	Hose I.D.				Thread UNF	A mm	B mm	E mm	W mm
	DN	Inch	Size	mm					
K37VS-6-6	10	3/8	-6	9.5	9/16x18	83	45	11	19
K3VS-8-6	10	3/8	-6	9.5	3/4x16	87	49	15	22
K3VS-8-8	12	1/2	-8	12.7	3/4x16	93	51	15	22
K3VS-10-8	12	1/2	-8	12.7	7/8x14	94	52	16	27
K37VS-12-8	12	1/2	-8	12.7	1 1/16x12	99	57	21	32

Approved fitting series for hose types:

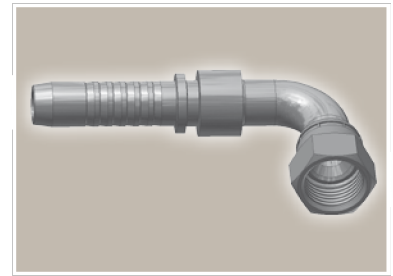
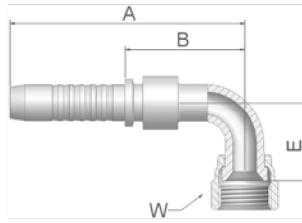
**VS** | -4 to -8 | H31 | H31TC | H31ST |

**39/3W Female JIC 37°**  
**SAE 45° – Dual Flare**  
**Swivel Female 90° Elbow**  
 ISO 12151-5-SWES – DKJ 90°



Part Number	 Hose I.D.				 Thread UNF	A mm	B mm	E mm	 W mm
	DN	Inch	Size	mm					
K39VS-6-6	10	3/8	-6	9.5	9/16x18	80	42	23	19
K3WVS-8-6	10	3/8	-6	9.5	3/4x16	80	42	29	22
K3WVS-8-8	12	1/2	-8	12.7	3/4x16	87	45	29	22
K3WVS-10-8	12	1/2	-8	12.7	7/8x14	87	45	32	27

Approved **fitting series** for hose types:

**VS** | -4 to -8 | H31 | H31TC | H31ST |

# 15 ISO 6162-1 Flange Straight

ISO 12151-3-S-L – SFL  
(21.0 MPa/ 3000 psi)

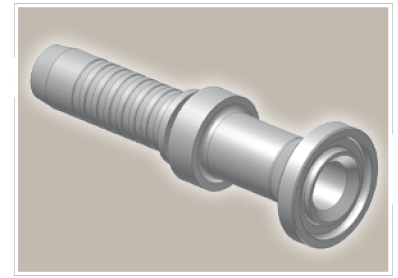
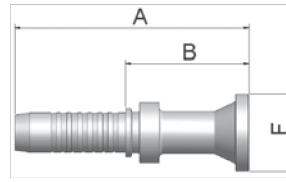

Part Number	Hose I.D.				Flange Inch	A mm	B mm	F mm
	DN	Inch	Size	mm				
K15VS-8-8	12	1/2	-8	12.7	1/2	102	59	30
K15VS-12-8	12	1/2	-8	12.7	3/4	77	34	38

SAE flange halves see in section Eb.

# 17 ISO 6162-1 Flange 45° Elbow

ISO 12151-3 – E45 – L – SFL 45°  
(21.0 MPa/ 3000 psi)

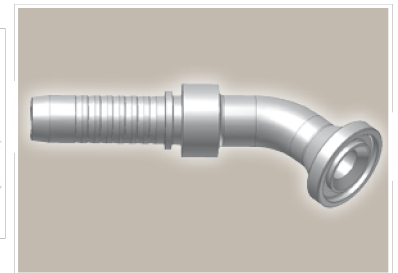
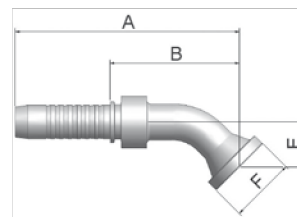

Part Number	Hose I.D.				Flange Inch	A mm	B mm	E mm	F mm
	DN	Inch	Size	mm					
K17VS-8-8	12	1/2	-8	12.7	1/2	100	57	20	30
K17VS-12-8	12	1/2	-8	12.7	3/4	101	58	21	38

SAE flange halves see in section Eb.

Approved **fitting series** for hose types:

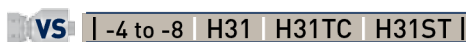

## 19 ISO 6162-1 Flange 90° Elbow

ISO 12151-3 – E– L – SFL 90°  
(21.0 MPa/ 3000 psi)

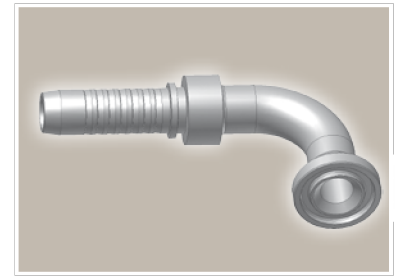
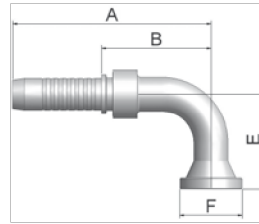

Part Number	Hose I.D.				Flange Inch	A mm	B mm	E mm	F mm
	DN	Inch	Size	mm					
K19VS-8-8	12	1/2	-8	12.7	1/2	92	50	41	30
K19VS-12-8	12	1/2	-8	12.7	3/4	92	50	42	38

SAE flange halves see in section Eb.

## 6A ISO 6162-2 Flange Straight

ISO 12151-3-S-S – SFS  
(42.0 MPa/ 6000 psi)

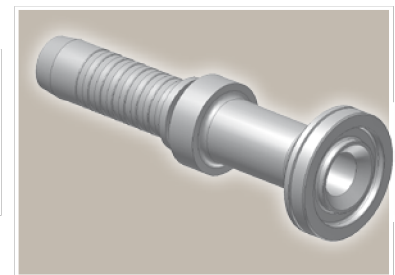
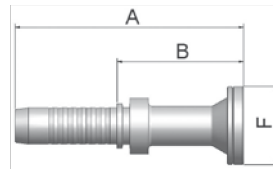

Part Number	Hose I.D.				Flange Inch	A mm	B mm	F mm
	DN	Inch	Size	mm				
K6AVS-8-8	12	1/2	-8	12.7	1/2	105	63	32
K6AVS-12-8	12	1/2	-8	12.7	3/4	79	36	41

SAE flange halves see in section Eb.

Approved **fitting series** for hose types:

**VS** | -4 to -8 | H31 | H31TC | H31ST |

**6F** **ISO 6162-2 Flange**  
**45° Elbow – Heavy Series**  
ISO 12151-3 – E45-S – SFS 45°  
(42.0 MPa/ 6000 psi)

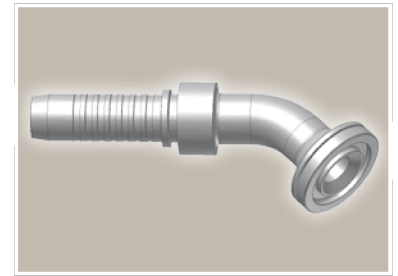
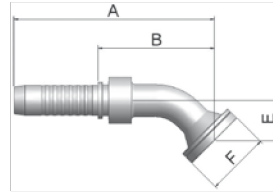

Part Number	Hose I.D.				Flange Inch	A mm	B mm	E mm	F mm
	DN	Inch	Size	mm					
K6FVS-8-8	12	1/2	-8	12.7	1/2	94	52	19	32
K6FVS-12-8	12	1/2	-8	12.7	3/4	106	64	26	41

SAE flange halves see in section Eb.

**6N** **ISO 6162-2 Flange**  
**90° Elbow**  
ISO 12151-3 – E-S – SFS 90°  
(42.0 MPa/ 6000 psi)

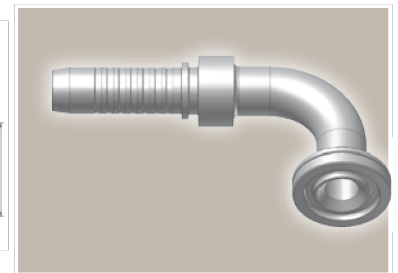
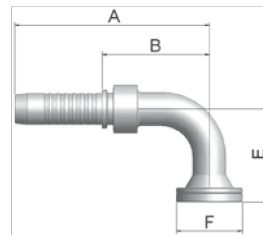

Part Number	Hose I.D.				Flange Inch	A mm	B mm	E mm	F mm
	DN	Inch	Size	mm					
K6NVS-8-8	12	1/2	-8	12.7	1/2	87	45	41	32
K6NVS-12-8	12	1/2	-8	12.7	3/4	92	50	45	41

SAE flange halves see in section Eb.

Approved **fitting series** for hose types:



## JC Female ORFS Swivel – Straight Short

ISO 12151-1 – SWSA  
SAE J516 – ORFS

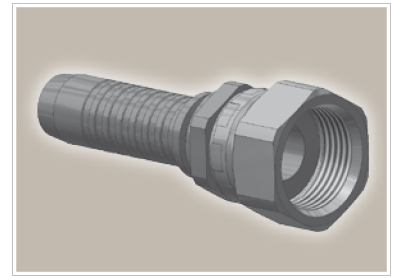
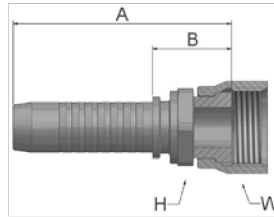

Part Number	Hose I.D.				Thread UNF	A mm	B mm	H mm	W mm
	DN	Inch	Size	mm					
KJCVS-6-6	10	3/8	-6	9.5	11/16x16	60	22	17	22
KJCVS-8-6	10	3/8	-6	9.5	13/16x16	62	23	19	24
KJCVS-8-8	12	1/2	-8	12.7	13/16x16	67	24	22	24
KJCVS-10-8	12	1/2	-8	12.7	1x14	69	26	24	30

## J7 Female ORFS – Swivel 45° Elbow

ISO 12151-1 – SWE 45°  
SAE J516 – ORFS 45°

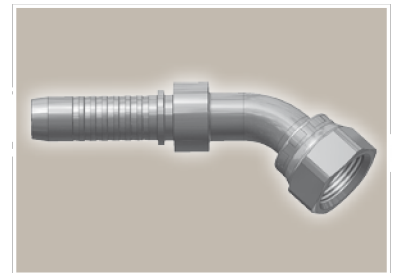
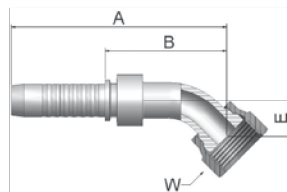

Part Number	Hose I.D.				Thread UNF	A mm	B mm	E mm	W mm
	DN	Inch	Size	mm					
KJ7VS-6-6	10	3/8	-6	9.5	11/16x16	83	45	11	22
KJ7VS-8-6	10	3/8	-6	9.5	13/16x16	89	51	15	24
KJ7VS-8-8	12	1/2	-8	12.7	13/16x16	93	51	15	24
KJ7VS-10-8	12	1/2	-8	12.7	1x14	96	53	16	30

Approved **fitting series** for hose types:

**VS** | -4 to -8 | H31 | H31TC | H31ST |

# J9

## Female ORFS – Swivel 90° Elbow – Short Drop

ISO 12151-1 – SWES  
SAE J516 – ORFS 90°

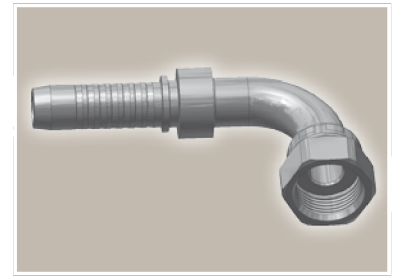
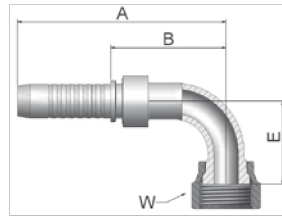

Part Number	Hose I.D.				Thread UNF	A mm	B mm	E mm	W mm
	DN	Inch	Size	mm					
KJ9VS-6-6	10	3/8	-6	9.5	11/16x16	80	42	23	22
KJ9VS-8-6	10	3/8	-6	9.5	13/16x16	83	45	29	24
KJ9VS-8-8	12	1/2	-8	12.7	13/16x16	87	45	29	24
KJ9VS-10-8	12	1/2	-8	12.7	1x14	88	46	30	30

Approved **fitting series** for hose types:

<b>VS</b>	-4 to -8	H31	H31TC	H31ST
-----------	----------	-----	-------	-------

## FG Male French Gas Series Rigid – Straight (24° Cone)

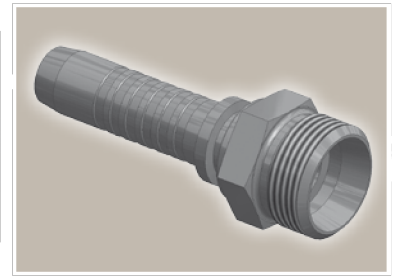
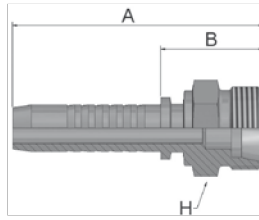

Part Number	Hose I.D.				Thread metric	Tube O.D. mm	A mm	B mm	H mm
	DN	Inch	Size	mm					
KFGVS-13-6	10	3/8	-6	9.5	M20x1.5	13.25	69	31	22
KFGVS-17-8	12	1/2	-8	12.7	M24x1.5	16.75	72	30	24

## F4 Female French Gas Series Swivel – Straight (Ball Nose)

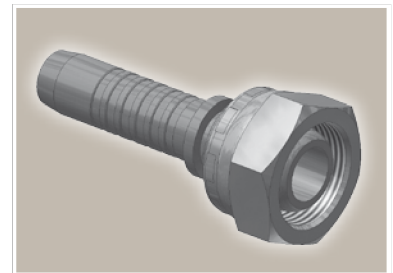
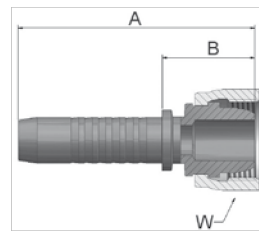

Part Number	Hose I.D.				Thread metric	Tube O.D. mm	A mm	B mm	W mm
	DN	Inch	Size	mm					
KF4VS-13-6	10	3/8	-6	9.5	M20x1.5	13.25	62	24	24
KF4VS-17-8	12	1/2	-8	12.7	M24x1.5	16.75	70	27	30

Approved **fitting series** for hose types:

VS | -4 to -8 | H31 | H31TC | H31ST |





## Shell

Page Df-1

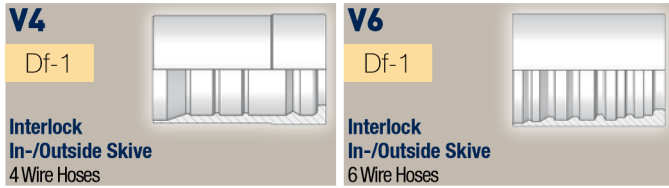

## DIN – Metric

Page Df-2 – Df-5

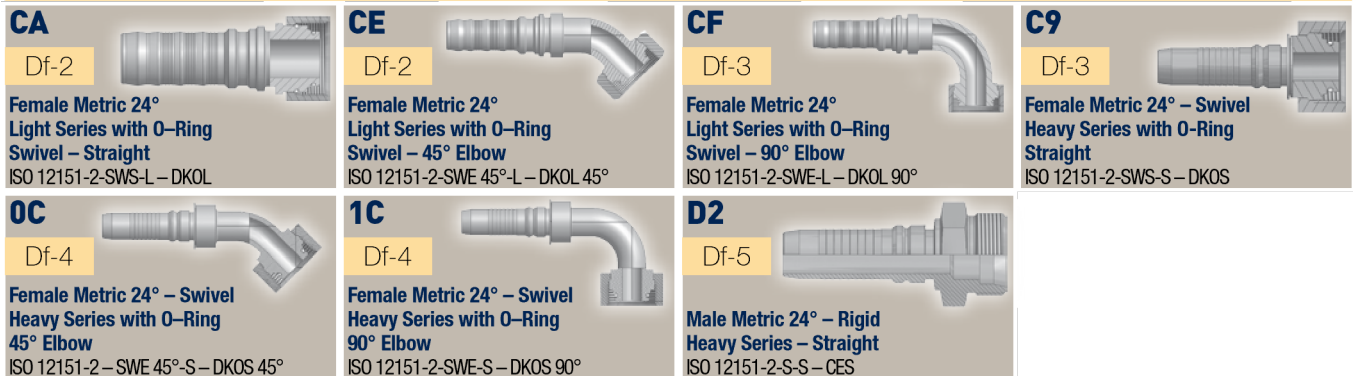

## BSP

Page Df-6 – Df-8

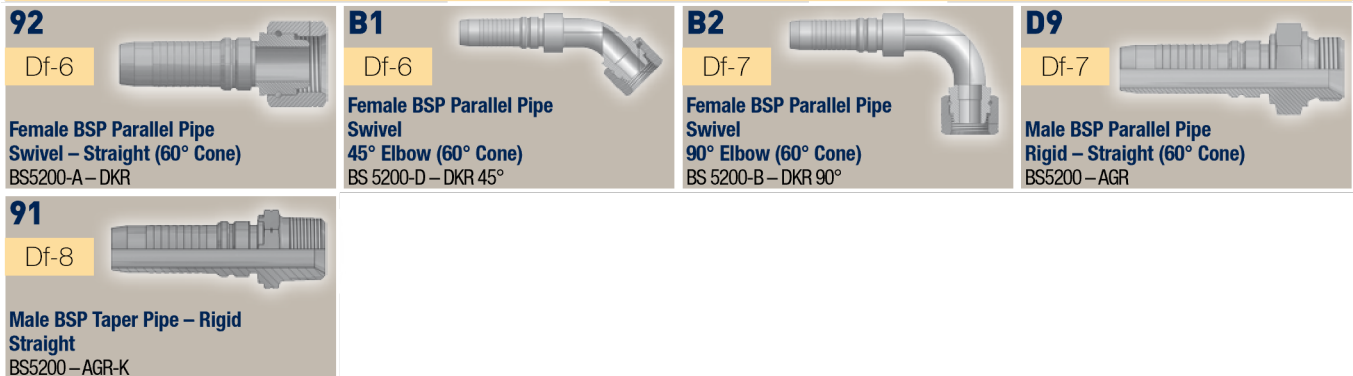

## SAE

Page Df-9 – Df-11

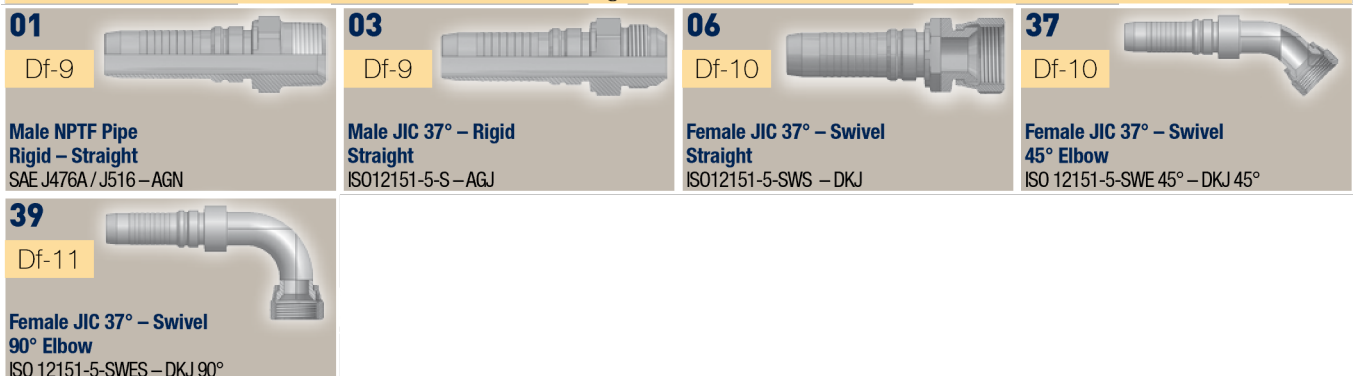





# Flange

Page Df-12 – Df-22

<p><b>15/4A</b> Df-12 ISO 6162-1 Flange Straight ISO 12151-3-S-L – SFL (35.0 MPa/ 5000 psi)</p> 	<p><b>17/4F</b> Df-13 ISO 6162-1 Flange 45° Elbow ISO 12151-3 – E45S – L – SFL 45° (35.0 MPa/ 5000 psi)</p> 	<p><b>19/4N</b> Df-14 ISO 6162-1 Flange 90° Elbow ISO 12151-3-E-L – SFL 90° (35.0 MPa/ 5000 psi)</p> 	<p><b>6A</b> Df-15 ISO 6162-2 Flange Straight ISO 12151-3-S-S – SFS (42.0 MPa/ 6000 psi)</p> 
<p><b>6F</b> Df-16 ISO 6162-2 Flange 45° Elbow – Heavy Series ISO 12151-3 – E45-S – SFS 45° (42.0 MPa/ 6000 psi)</p> 	<p><b>6N</b> Df-17 ISO 6162-2 Flange 90° Elbow ISO 12151-3 – E-S – SFS 90° (42.0 MPa/ 6000 psi)</p> 	<p><b>8A</b> Df-18 Flange – Straight 8000 psi</p> 	<p><b>8F</b> Df-18 Flange – 45° Elbow 8000 psi</p> 
<p><b>8N</b> Df-19 Flange – 90° Elbow 8000 psi</p> 	<p><b>X5</b> Df-19 Flange – Straight Full flange system for ISO 6162-1 or ISO 6162-2</p> 	<p><b>X7</b> Df-20 Flange – 45° Elbow Full flange system for ISO 6162-1 or ISO 6162-2</p> 	<p><b>X9</b> Df-20 Flange – 90° Elbow Full flange system for ISO 6162-1 or ISO 6162-2</p> 
<p><b>PY</b> Df-21 Flange – 24° Male French Gas Straight</p> 	<p><b>XA</b> Df-21 Caterpillar® Flange Straight</p> 	<p><b>XF</b> Df-22 Caterpillar® Flange 45° Elbow</p> 	<p><b>XG</b> Df-22 Caterpillar® Flange 60° Elbow</p> 
<p><b>XN</b> Df-23 Caterpillar® Flange 90° Elbow</p> 			

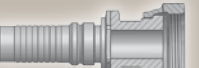
# ORFS

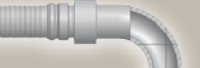
Page Df-23 – Df-25

<p><b>JC</b> Df-24 Female ORFS Swivel – Straight Short ISO 12151-1 – SWSA</p> 	<p><b>JS</b> Df-24 ORFS Swivel Female (Long) ISO 12151-1-SWSB SAE J516 – ORFS</p> 	<p><b>J7</b> Df-25 Female ORFS – Swivel 45° Elbow ISO 12151-1 – SWE 45° SAE J516 – ORFS 45°</p> 	<p><b>J9</b> Df-25 Female ORFS – Swivel 90° Elbow – Short Drop ISO 12151-1 – SWES SAE J516 – ORFS 90°</p> 
<p><b>JM</b> Df-26 ORFS Male ISO 12151-1-S – SAE J516</p> 			

# French Standard

Page Df-26

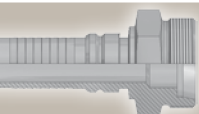
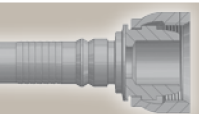
<p><b>FG</b> Df-27 Male French Gas Series Rigid – Straight (24° Cone)</p> 	<p><b>F4</b> Df-27 Female French Gas Series Swivel – Straight (Ball Nose)</p> 
---	---



## V4 Interlock In-/Outside Skive

4 Wire Hoses

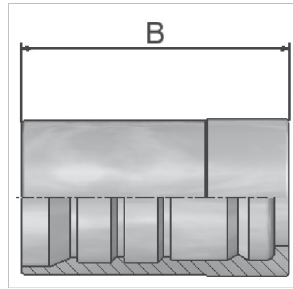

Only for use with adjustable crimpers. Minimum of 320 tons crimping force recommended.

Part Number	 Hose I.D.				B mm
	DN	Inch	Size	mm	
100V4-10	16	5/8	-10	15.9	49
100V4-12	19	3/4	-12	19.1	60
100V4-16	25	1	-16	25.4	75
100V4-20	31	1 1/4	-20	31.8	88
100V4-24	38	1 1/2	-24	38.1	94
100V4-32	51	2	-32	50.8	99

## V6 Interlock In-/Outside Skive

6 Wire Hoses

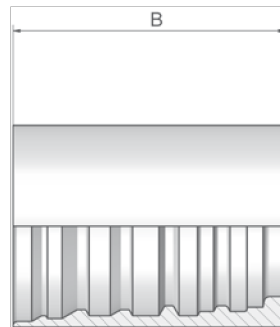

Only for use with adjustable crimpers. Minimum of 340 tons crimping force required.

Part Number	 Hose I.D.				B mm
	DN	Inch	Size	mm	
100V6-20	31	1 1/4	-20	31.8	90
100V6-24	38	1 1/2	-24	38.1	96
100V6-32	51	2	-32	50.8	110
100V6-40	63	2 1/2	-40	63.5	134
100V6-48	76	3	-48	76.2	110

**CA** **Female Metric 24°  
Light Series with O-Ring  
Swivel – Straight**  
ISO 12151-2-SWS-L – DKOL

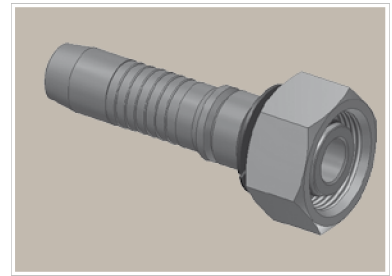
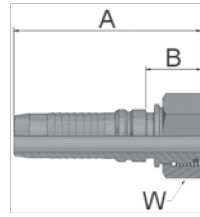

Part Number	Hose I.D.				Thread metric	Tube O.D. mm	A mm	B mm	W mm
	DN	Inch	Size	mm					
KCAV4-22-12	19	3/4	-12	19.1	M30x2	22	89	28	36
KCAV4-28-16	25	1	-16	25.4	M36x2	28	103	31	41
KCAV6-35-20	31	1 1/4	-20	31.8	M45x2	35	130	39	50
KCAV4-35-20	31	1 1/4	-20	31.8	M45x2	35	120	32	50
KCAV4-42-24	38	1 1/2	-24	38.1	M52x2	42	128	35	60
KCAV6-42-24	38	1 1/2	-24	38.1	M52x2	42	138	42	60

Fittings with standard O-ring seals can be used for temperatures from -40 °C up to +105 °C.  
O-rings see section Eb. Special O-rings are available on request.

**CE** **Female Metric 24°  
Light Series with O-Ring  
Swivel – 45° Elbow**  
ISO 12151-2-SWE 45°-L – DKOL 45°

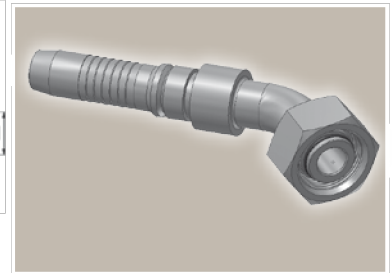
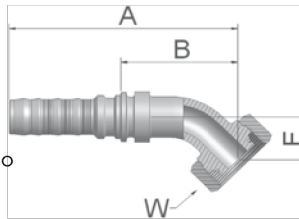

Part Number	Hose I.D.				Thread metric	Tube O.D. mm	A mm	B mm	E mm	W mm
	DN	Inch	Size	mm						
KCEV4-22-12	19	3/4	-12	19.1	M30x2	22	137	75	29	36
KCEV4-35-20	31	1 1/4	-20	31.8	M45x2	35	197	109	37	50
KCEV6-35-20	31	1 1/4	-20	31.8	M45x2	35	188	97	37	50
KCEV6-42-24	38	1 1/2	-24	38.1	M52x2	42	226	130	49	60

Fittings with standard O-ring seals can be used for temperatures from -40 °C up to +105 °C.  
O-rings see section Eb. Special O-rings are available on request.

Approved **fitting series** for hose types:

Also available in stainless steel. Details can be found in CAT 4400.1/UK

<b>V4</b>	-10 up to -16	H31	H31TC	H31ST	R42	R42TC	R42ST	-12 up to -20	R35	R35TC	H29	all sizes	H29TC	H29ST	H29RH
<b>V6</b>	-24 up to -48														
	R35	R35TC	RS35TC-48	-20 up to -32			R42	R42ST	R42TC						

**CF** **Female Metric 24°  
Light Series with O-Ring  
Swivel – 90° Elbow**  
ISO 12151-2-SWE-L – DKOL 90°

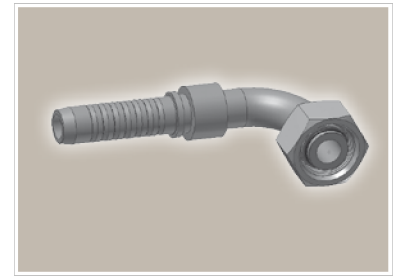
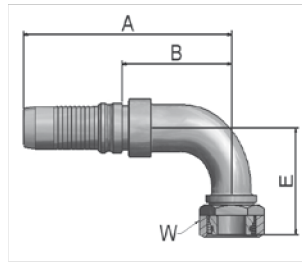

Part Number	Hose I.D.				Thread metric	Tube O.D. mm	A mm	B mm	E mm	W mm
	DN	Inch	Size	mm						
KCFV4-22-16	25	1	-16	25.4	M30x2	22	150	77	70	36
KCFV4-35-20	31	1 1/4	-20	31.8	M45x2	35	186	98	79	50
KCFV6-35-20	31	1 1/4	-20	31.8	M45x2	35	177	86	79	50
KCFV6-42-24	38	1 1/2	-24	38.1	M52x2	42	209	113	101	60

Fittings with standard O-ring seals can be used for temperatures from -40 °C up to +105 °C.  
O-rings see section Eb. Special O-rings are available on request.

**C9** **Female Metric 24° – Swivel  
Heavy Series with O-Ring  
Straight**  
ISO 12151-2-SWS-S – DKOS

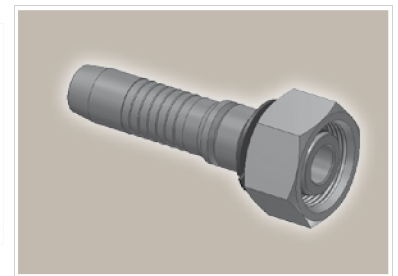
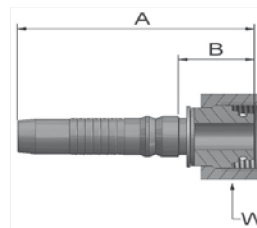

Part Number	Hose I.D.				Thread metric	Tube O.D. mm	A mm	B mm	W mm
	DN	Inch	Size	mm					
KC9V4-20-10	16	5/8	-10	15.9	M30x2	20	87	27	36
KC9V4-20-12	19	3/4	-12	19.1	M30x2	20	88	26	36
KC9V4-25-12	19	3/4	-12	19.1	M36x2	25	91	30.3	46
KC9V4-30-12	19	3/4	-12	19.1	M42x2	30	95	33	50
KC9V4-25-16	25	1	-16	25.4	M36x2	25	103	30	46
KC9V4-30-16	25	1	-16	25.4	M42x2	30	108	35	50
KC9V4-38-16	25	1	-16	25.4	M52x2	38	110	37	60
KC9V6-30-20	31	1 1/4	-20	31.8	M42x2	30	131.5	41.5	50
KC9V4-30-20	31	1 1/4	-20	31.8	M42x2	30	123	35	50
KC9V6-38-20	31	1 1/4	-20	31.8	M52x2	38	135	44	60
KC9V4-38-20	31	1 1/4	-20	31.8	M52x2	38	126	38	60
KC9V6-38-24	38	1 1/2	-24	38.1	M52x2	38	139	43	60
KC9V4-38-24	38	1 1/2	-24	38.1	M52x2	38	129	36	60
KC9V6-54-32	51	2	-32	50.8	M68x2	54	175	65	80

Fittings with standard O-ring seals can be used for temperatures from -40 °C up to +105 °C.  
O-rings see section Eb. Special O-rings are available on request.

Approved **fitting series** for hose types:

Also available in stainless steel. Details can be found in CAT 4400.1/UK

<b>V4</b>	-10 up to -16	H31	H31TC	H31ST	R42	R42TC	R42ST	-12 up to -20	R35	R35TC	H29	all sizes	H29TC	H29ST	H29RH	
<b>V6</b>	-24 up to -48															
	R35	R35TC	RS35TC-48	-20 up to -32	R42	R42ST	R42TC									

## 0C Female Metric 24° – Swivel Heavy Series with O-Ring 45° Elbow

ISO 12151-2 – SWE 45°-S – DKOS 45°

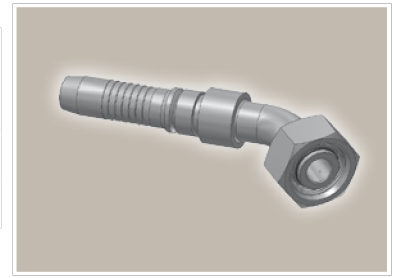
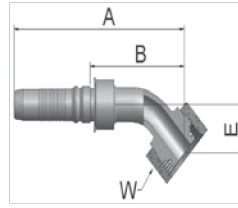

Part Number	Hose I.D.				Thread metric	Tube O.D. mm	A mm	B mm	E mm	W mm
	DN	Inch	Size	mm						
K0CV4-20-10	16	5/8	-10	15.9	M30x2	20	124	65	26	36
K0CV4-20-12	19	3/4	-12	19.1	M30x2	20	138	76	30	36
K0CV4-25-12	19	3/4	-12	19.1	M36x2	25	137	76	29	46
K0CV4-25-16	25	1	-16	25.4	M36x2	25	161	88	33	46
K0CV4-30-16	25	1	-16	25.4	M42x2	30	162	88.7	33	50
K0CV6-30-20	31	1 1/4	-20	31.8	M42x2	30	184	93	34	50
K0CV4-30-20	31	1 1/4	-20	31.8	M42x2	30	193	105	34	50
K0CV4-38-20	31	1 1/4	-20	31.8	M52x2	38	197	108.7	37	60
K0CV6-38-20	31	1 1/4	-20	31.8	M52x2	38	187	96.3	37	60
K0CV6-38-24	38	1 1/2	-24	38.1	M52x2	38	226	130	49	60
K0CV4-38-24	38	1 1/2	-24	38.1	M52x2	38	227	133	49	60

Fittings with standard O-ring seals can be used for temperatures from -40 °C up to +105 °C.  
O-rings see section Eb. Special O-rings are available on request.

## 1C Female Metric 24° – Swivel Heavy Series with O-Ring 90° Elbow

ISO 12151-2-SWE-S – DKOS 90°

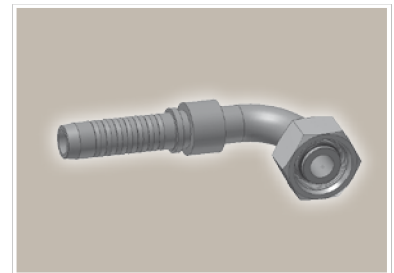
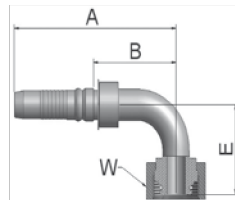

Part Number	Hose I.D.				Thread metric	Tube O.D. mm	A mm	B mm	E mm	W mm
	DN	Inch	Size	mm						
K1CV4-20-10	16	5/8	-10	15.9	M30x2	20	112	52.3	50	36
K1CV4-20-12	19	3/4	-12	19.1	M30x2	20	125	63	60	36
K1CV4-25-12	19	3/4	-12	19.1	M36x2	25	126	65	59	46
K1CV4-25-16	25	1	-16	25.4	M36x2	25	150	77	69	46
K1CV4-30-16	25	1	-16	25.4	M42x2	30	151	77.7	69	50
K1CV4-38-16	25	1	-16	25.4	M52x2	38	150	77	68	60
K1CV4-30-20	31	1 1/4	-20	31.8	M42x2	30	183	95	73	50
K1CV6-30-20	31	1 1/4	-20	31.8	M42x2	30	169	78	69	50
K1CV4-38-20	31	1 1/4	-20	31.8	M52x2	38	187	98.7	78	60
K1CV6-38-20	31	1 1/4	-20	31.8	M52x2	38	177	86.3	78	60
K1CV4-38-24	38	1 1/2	-24	38.1	M52x2	38	210	117	101	60
K1CV6-38-24	38	1 1/2	-24	38.1	M52x2	38	209	113	101	60

Fittings with standard O-ring seals can be used for temperatures from -40 °C up to +105 °C.  
O-rings see section Eb. Special O-rings are available on request.

Approved **fitting series** for hose types:

Also available in stainless steel. Details can be found in CAT 4400.1/UK

<b>V4</b>	-10 up to -16	H31	H31TC	H31ST	R42	R42TC	R42ST	-12 up to -20	R35	R35TC	H29	all sizes	H29TC	H29ST	H29RH
<b>V6</b>	-24 up to -48														
	R35	R35TC	RS35TC-48	-20 up to -32			R42	R42ST	R42TC						



# D2

## Male Metric 24° – Rigid Heavy Series – Straight

ISO 12151-2-S-S – CES

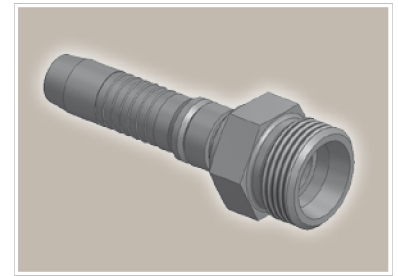
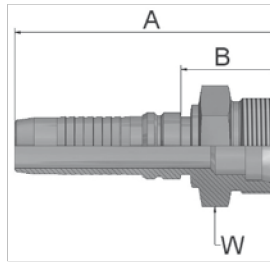

Part Number	Hose I.D.				Thread metric	Tube O.D. mm	A mm	B mm	H mm
	DN	Inch	Size	mm					
KD2V4-20-12	19	3/4	-12	19.1	M30x2	20	93	31	30
KD2V4-25-12	19	3/4	-12	19.1	M36x2	25	98	36.3	36
KD2V4-25-16	25	1	-16	25.4	M36x2	25	110.3	37.7	46
KD2V4-30-16	25	1	-16	25.4	M42x2	30	115	41.7	46
KD2V6-30-20	31	1 1/4	-20	31.8	M42x2	30	140	59	46
KD2V6-38-20	31	1 1/4	-20	31.8	M52x2	38	142	51	55
KD2V4-38-20	31	1 1/4	-20	31.8	M52x2	38	135	46.7	55
KD2V6-38-24	38	1 1/2	-24	38.1	M52x2	38	151	55	55
KD2V4-38-24	38	1 1/2	-24	38.1	M52x2	38	139	46	55

Approved **fitting series** for hose types:

Also available in stainless steel. Details can be found in CAT 4400.1/UK

<b>V4</b>	-10 up to -16   H31   H31TC   H31ST   R42   R42TC   R42ST   -12 up to -20   R35   R35TC   H29   all sizes   H29TC   H29ST   H29RH
<b>V6</b>	-24 up to -48   R35   R35TC   RS35TC-48   -20 up to -32   R42   R42ST   R42TC

## 92 Female BSP Parallel Pipe Swivel – Straight (60° Cone)

BS5200-A – DKR

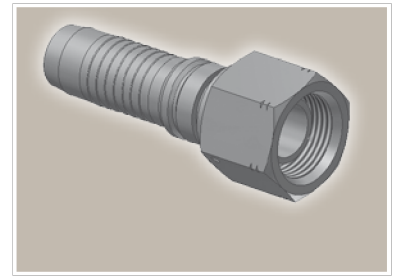
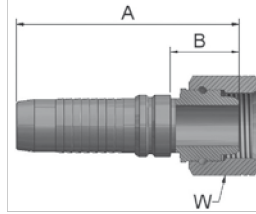

Part Number	Hose I.D.				Thread BSP	A mm	B mm	W mm
	DN	Inch	Size	mm				
K92V4-10-10	16	5/8	-10	15.9	5/8x14	80	20.3	30
K92V4-12-12	19	3/4	-12	19.1	3/4x14	85	23.3	32
K92V4-16-12	19	3/4	-12	19.1	1x11	93	31.3	41
K92V4-16-16	25	1	-16	25.4	1x11	105	32	41
K92V6-20-20	31	1 1/4	-20	31.8	1 1/4x11	127	36	50
K92V4-20-20	31	1 1/4	-20	31.8	1 1/4x11	118	30	50
K92V6-24-24	38	1 1/2	-24	38.1	1 1/2x11	134	38	55
K92V4-24-24	38	1 1/2	-24	38.1	1 1/2x11	124	30.9	55
K92V6-32-32	51	2	-32	50.8	2x11	151	41	70
K92V4-32-32	51	2	-32	50.8	2x11	131	34.2	70

## B1 Female BSP Parallel Pipe Swivel 45° Elbow (60° Cone)

BS 5200-D – DKR 45°

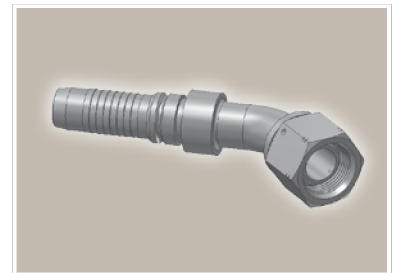
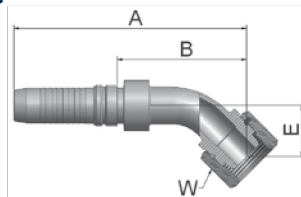

Part Number	Hose I.D.				Thread BSP	A mm	B mm	E mm	W mm
	DN	Inch	Size	mm					
KB1V4-12-12	19	3/4	-12	19.1	3/4x14	134	72.3	26	32
KB1V4-16-16	25	1	-16	25.4	1x11	164	91	36	41
KB1V6-20-20	31	1 1/4	-20	31.8	1 1/4x11	194	103	43	50
KB1V4-20-20	31	1 1/4	-20	31.8	1 1/4x11	198	109.7	38	50
KB1V6-24-24	38	1 1/2	-24	38.1	1 1/2x11	229	133	52	55
KB1V4-24-24	38	1 1/2	-24	38.1	1 1/2x11	230	137	52	55
KB1V6-32-32	51	2	-32	50.8	2x11	288	178	70	70
KB1V4-32-32	51	2	-32	50.8	2x11	277	180	70	70

Approved fitting series for hose types:

Also available in stainless steel. Details can be found in CAT 4400.1/UK

V4	-10 up to -16	H31	H31TC	H31ST	R42	R42TC	R42ST	-12 up to -20	R35	R35TC	H29	all sizes	H29TC	H29ST	H29RH
V6	-24 up to -48														
	R35	R35TC	RS35TC-48	-20 up to -32		R42	R42ST	R42TC							

## B2 Female BSP Parallel Pipe Swivel 90° Elbow (60° Cone)

BS 5200-B – DKR 90°

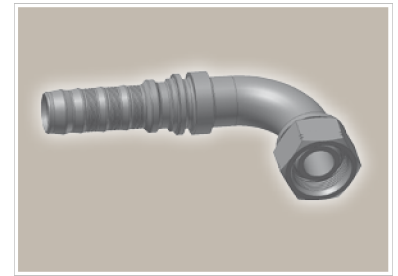
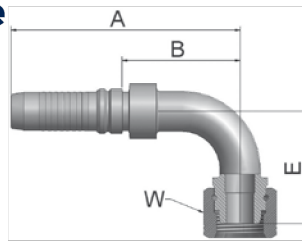

Part Number	Hose I.D.				Thread BSP	A mm	B mm	E mm	W mm
	DN	Inch	Size	mm					
KB2V4-12-12	19	3/4	-12	19.1	3/4x14	125	63.3	55	32
KB2V4-16-16	25	1	-16	25.4	1x11	150	77	74	41
KB2V6-20-20	31	1 1/4	-20	31.8	1 1/4x11	177	86	80	50
KB2V4-20-20	31	1 1/4	-20	31.8	1 1/4x11	186	98.7	80	50
KB2V6-24-24	38	1 1/2	-24	38.1	1 1/2x11	209	113	103	55
KB2V4-24-24	38	1 1/2	-24	38.1	1 1/2x11	210	116.9	103	55
KB2V6-32-32	51	2	-32	50.8	2x11	268	157	149	70
KB2V4-32-32	51	2	-32	50.8	2x11	257	160	149	70

## D9 Male BSP Parallel Pipe Rigid – Straight (60° Cone)

BS5200 – AGR

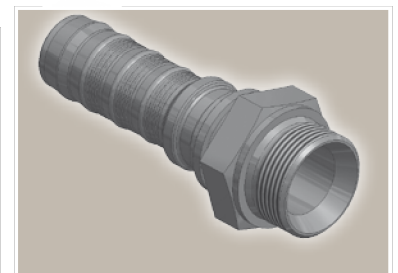
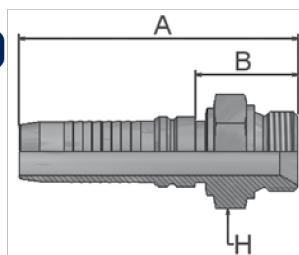

Part Number	Hose I.D.				Thread BSP	A mm	B mm	H mm
	DN	Inch	Size	mm				
KD9V4-10-10	16	5/8	-10	15.9	5/8x14	94	35	30
KD9V4-12-12	19	3/4	-12	19.1	3/4x14	99	37.3	32
KD9V4-16-16	25	1	-16	25.4	1x11	115	42.7	41
KD9V6-20-20	31	1 1/4	-20	31.8	1 1/4x11	139	48	50
KD9V4-20-20	31	1 1/4	-20	31.8	1 1/4x11	134	46.2	50
KD9V6-24-24	38	1 1/2	-24	38.1	1 1/2x11	155	58	55
KD9V4-24-24	38	1 1/2	-24	38.1	1 1/2x11	142	48.4	55
KD9V6-32-32	51	2	-32	50.8	2x11	168	58	70
KD9V4-32-32	51	2	-32	50.8	2x11	148	50	70

Approved fitting series for hose types:

Also available in stainless steel. Details can be found in CAT 4400.1/UK

<b>V4</b>	-10 up to -16	H31	H31TC	H31ST	R42	R42TC	R42ST	-12 up to -20	R35	R35TC	H29	all sizes	H29TC	H29ST	H29RH									
<b>V6</b>	-24 up to -48																R35	R35TC	RS35TC-48	-20 up to -32	R42	R42ST	R42TC	

# 91 Male BSP Taper Pipe – Rigid Straight

BS5200 – AGR-K

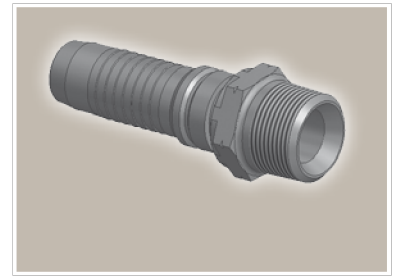
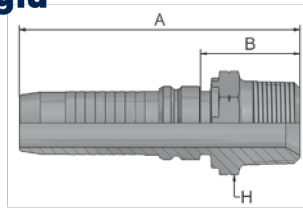

Part Number	Hose I.D.				Thread BSP	A mm	B mm	H mm
	DN	Inch	Size	mm				
K91V4-12-12	19	3/4	-12	19.1	3/4x14	99	37	30
K91V4-16-16	25	1	-16	25.4	1x11	113	40	36
K91V4-20-20	31	1 1/4	-20	31.8	1 1/4x11	138	50	46
K91V4-24-24	38	1 1/2	-24	38.1	1 1/2x11	144	59	55
K91V4-32-32	51	2	-32	50.8	2x11	154	56	65

Approved **fitting series** for hose types:

Also available in stainless steel. Details can be found in CAT 4400.1/UK

<b>V4</b>	-10 up to -16	H31	H31TC	H31ST	R42	R42TC	R42ST	-12 up to -20	R35	R35TC	H29	all sizes	H29TC	H29ST	H29RH		
<b>V6</b>	-24 up to -48																
	R35	R35TC	RS35TC-48	-20 up to -32											R42	R42ST	R42TC

# 01

## Male NPTF Pipe Rigid – Straight

SAE J476A/ J516 – AGN

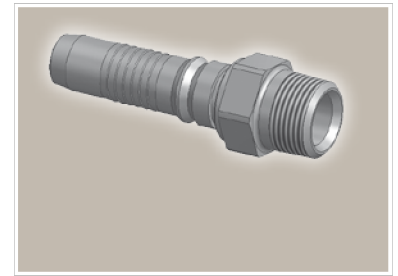
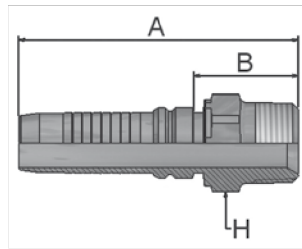

Part Number	Hose I.D.				Thread NPTF	A mm	B mm	H mm
	DN	Inch	Size	mm				
K01V4-12-12	19	3/4	-12	19.1	3/4x14	100	38.3	30
K01V4-16-16	25	1	-16	25.4	1x11 1/2	116.5	43.9	36
K01V6-20-20	31	1 1/4	-20	31.8	1 1/4x11 1/2	151	60.2	46
K01V4-20-20	31	1 1/4	-20	31.8	1 1/4x11 1/2	146	58.2	46
K01V4-24-24	38	1 1/2	-24	38.1	1 1/2x11 1/2	148.4	55.3	50
K01V6-24-24	38	1 1/2	-24	38.1	1 1/2x11 1/2	159	62.7	50
K01V6-32-32	51	2	-32	50.8	2x11 1/2	181	70	65
K01V4-32-32	51	2	-32	50.8	2x11 1/2	159.8	62.3	65
K01V6-48-40	63	2 1/2	-40	63.5	3 8	213	77	95
K01V6-48-48	76	3	-48	76.2	3 8	180	73	95

# 03

## Male JIC 37° – Rigid Straight

ISO12151-5-S – AGJ

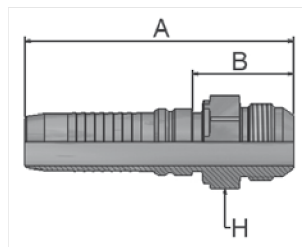

Part Number	Hose I.D.				Thread UNF	A mm	B mm	H mm
	DN	Inch	Size	mm				
K03V4-12-12	19	3/4	-12	19.1	1 1/16x12	101	39.3	30
K03V4-16-12	19	3/4	-12	19.1	1 5/16x12	103	41.3	36
K03V4-16-16	25	1	-16	25.4	1 5/16x12	117	44.1	36
K03V4-20-16	25	1	-16	25.4	1 5/8x12	122	49.5	46
K03V6-20-20	31	1 1/4	-20	31.8	1 5/8x12	147	56	46
K03V4-20-20	31	1 1/4	-20	31.8	1 5/8x12	139	50.7	46
K03V4-24-20	31	1 1/4	-20	31.8	1 7/8x12	139	51	50
K03V6-24-24	38	1 1/2	-24	38.1	1 7/8x12	156	60	50
K03V4-24-24	38	1 1/2	-24	38.1	1 7/8x12	146	52.6	50
K03V6-32-32	51	2	-32	50.8	2 1/2x12	182	72	65
K03V4-32-32	51	2	-32	50.8	2 1/2x12	161	64	65

Approved fitting series for hose types:

Also available in stainless steel. Details can be found in CAT 4400.1/UK

<b>V4</b>	-10 up to -16	H31	H31TC	H31ST	R42	R42TC	R42ST	-12 up to -20	R35	R35TC	H29	all sizes	H29TC	H29ST	H29RH
<b>V6</b>	-24 up to -48	R35	R35TC	RS35TC-48	-20 up to -32	R42	R42ST	R42TC							

## 06 Female JIC 37° – Swivel Straight

ISO12151-5-SWS – DKJ

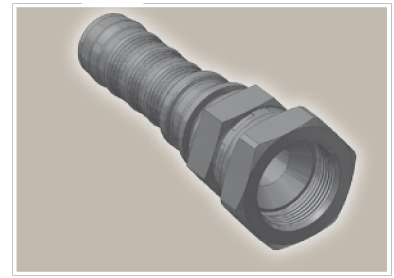
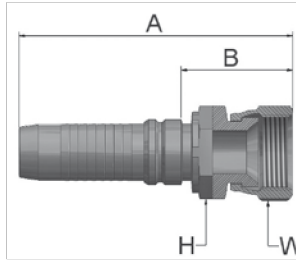

Part Number	Hose I.D.				Thread UNF	A mm	B mm	H mm	W mm
	DN	Inch	Size	mm					
K06V4-12-12	19	3/4	-12	19.1	1 1/16x12	105	43	30	32
K06V4-16-12	19	3/4	-12	19.1	1 5/16x12	109	48	36	41
K06V4-16-16	25	1	-16	25.4	1 5/16x12	122	50	36	41
K06V4-20-16	25	1	-16	25.4	1 5/8x12	125	52	41	50
K06V4-20-20	31	1 1/4	-20	31.8	1 5/8x12	146	58	46	50
K06V6-20-20	31	1 1/4	-20	31.8	1 5/8x12	154	63	46	50
K06V6-24-20	31	1 1/4	-20	31.8	1 7/8x12	159	68	50	60
K06V4-24-20	31	1 1/4	-20	31.8	1 7/8x12	150	63	50	60
K06V6-24-24	38	1 1/2	-24	38.1	1 7/8x12	163	67	50	60
K06V4-24-24	38	1 1/2	-24	38.1	1 7/8x12	152	59	50	60
K06V4-32-32	51	2	-32	50.8	2 1/2x12	168	70	65	75
K06V6-32-32	51	2	-32	50.8	2 1/2x12	188	77	65	75

## 37 Female JIC 37° – Swivel 45° Elbow

ISO 12151-5-SWE 45° – DKJ 45°

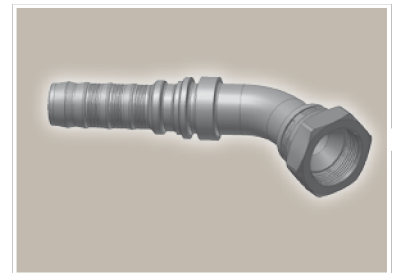
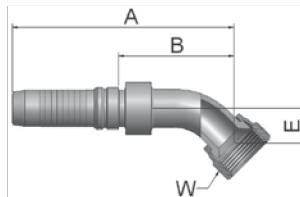

Part Number	Hose I.D.				Thread UNF	A mm	B mm	E mm	W mm
	DN	Inch	Size	mm					
K37V4-12-12	19	3/4	-12	19.1	1 1/16x12	129	67	22	32
K37V4-16-16	25	1	-16	25.4	1 5/16x12	152	79.7	24	41
K37V6-20-20	31	1 1/4	-20	31.8	1 5/8x12	192	101	42	50
K37V4-20-20	31	1 1/4	-20	31.8	1 5/8x12	201	113	42	50
K37V6-24-24	38	1 1/2	-24	38.1	1 7/8x12	235	139	58	60
K37V4-24-24	38	1 1/2	-24	38.1	1 7/8x12	227	133.9	49	60
K37V6-32-32	51	2	-32	50.8	2 1/2x12	290	180	72	75
K37V4-32-32	51	2	-32	50.8	2 1/2x12	279	182	72	75

Approved **fitting series** for hose types:

Also available in stainless steel. Details can be found in CAT 4400.1/UK

<b>V4</b>	-10 up to -16	H31	H31TC	H31ST	R42	R42TC	R42ST	-12 up to -20	R35	R35TC	H29	all sizes	H29TC	H29ST	H29RH
<b>V6</b>	-24 up to -48														
	R35	R35TC	RS35TC-48	-20 up to -32			R42	R42ST	R42TC						

39

**Female JIC 37° – Swivel  
90° Elbow**

ISO 12151-5-SWES – DKJ 90°

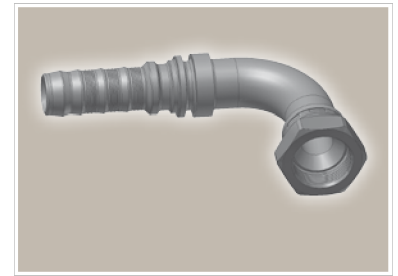
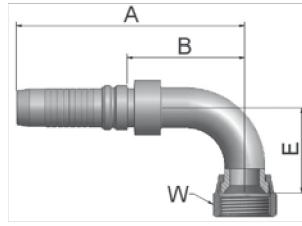

Part Number	Hose I.D.				Thread UNF	A mm	B mm	E mm	W mm
	DN	Inch	Size	mm					
K39V4-12-12	19	3/4	-12	19.1	1 1/16x12	125	63.3	48	32
K39V4-16-12	19	3/4	-12	19.1	1 5/16x12	125	63.3	56	41
K39V4-16-16	25	1	-16	25.4	1 5/16x12	150	77.7	56	41
K39V4-20-16	25	1	-16	25.4	1 5/8x12	150	77	62	50
K39V4-20-20	31	1 1/4	-20	31.8	1 5/8x12	186	98	85	50
K39V6-20-20	31	1 1/4	-20	31.8	1 5/8x12	177	86	85	50
K39V4-24-20	31	1 1/4	-20	31.8	1 7/8x12	186	98	80	60
K39V6-24-24	38	1 1/2	-24	38.1	1 7/8x12	209	113	102	60
K39V4-24-24	38	1 1/2	-24	38.1	1 7/8x12	210	116.9	102	60
K39V6-32-32	51	2	-32	50.8	2 1/2x12	268	157	152	75
K39V4-32-32	51	2	-32	50.8	2 1/2x12	257	160	152	75

Approved fitting series for hose types:



Also available in stainless steel. Details can be found in CAT 4400.1/UK

<b>V4</b>	-10 up to -16   H31   H31TC   H31ST   R42   R42TC   R42ST   -12 up to -20   R35   R35TC   H29   all sizes   H29TC   H29ST   H29RH
<b>V6</b>	-24 up to -48   R35   R35TC   RS35TC-48   -20 up to -32   R42   R42ST   R42TC

# 15/4A ISO 6162-1 Flange Straight

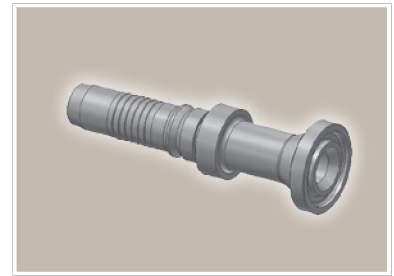
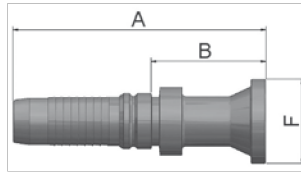
ISO 12151-3-S-L – SFL  
(35.0 MPa/ 5000 psi)



Part Number	 Hose I.D.				 Flange	A mm	B mm	F mm
	DN	Inch	Size	mm	Inch			
K15V4-12-12	19	3/4	-12	19.1	3/4	119	58	38
K15V4-16-12	19	3/4	-12	19.1	1	100	38.3	45
K15V4-12-16	25	1	-16	25.4	3/4	134.8	62.2	38
K15V4-16-16	25	1	-16	25.4	1	133	61	45
K4AV4-20-16	25	1	-16	25.4	1 1/4	101	28	51
K15V6-16-20	31	1 1/4	-20	31.8	1	161	70	44
K15V4-16-20	31	1 1/4	-20	31.8	1	152	64	45
K4AV6-20-20	31	1 1/4	-20	31.8	1 1/4	167	76	51
K4AV4-20-20	31	1 1/4	-20	31.8	1 1/4	160	72	51
K4AV4-24-20	31	1 1/4	-20	31.8	1 1/2	126	38.7	60
K4AV6-24-20	31	1 1/4	-20	31.8	1 1/2	165	74	60
K4AV4-20-24	38	1 1/2	-24	38.1	1 1/4	167	73	51
K4AV6-24-24	38	1 1/2	-24	38.1	1 1/2	201	105	60
K4AV4-24-24	38	1 1/2	-24	38.1	1 1/2	190	97	60
K4AV6-32-24	38	1 1/2	-24	38.1	2	159	63	71
K4AV4-32-24	38	1 1/2	-24	38.1	2	149	56	71
K4AV6-32-32	51	2	-32	50.8	2	210	100	71
K4AV4-32-32	51	2	-32	50.8	2	189	92	71

Approved **fitting series** for hose types:

Also available in stainless steel. Details can be found in CAT 4400.1/UK

<b>V4</b>	-10 up to -16	H31	H31TC	H31ST	R42	R42TC	R42ST	-12 up to -20	R35	R35TC	H29	all sizes	H29TC	H29ST	H29RH
<b>V6</b>	-24 up to -48														
	R35	R35TC	RS35TC-48	-20 up to -32		R42	R42ST	R42TC							



# 17/4F ISO 6162-1 Flange 45° Elbow

ISO 12151-3 – E45S – L – SFL 45°  
(35.0 MPa/ 5000 psi)

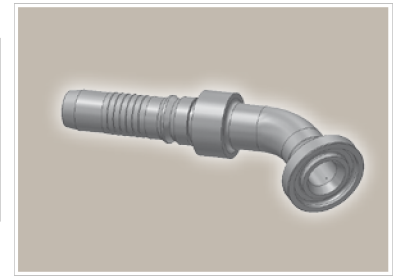
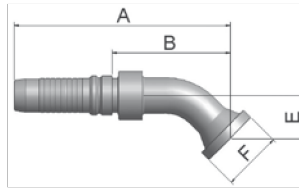

Part Number	Hose I.D.				Flange Inch	A mm	B mm	E mm	F mm
	DN	Inch	Size	mm					
K17V4-12-12	19	3/4	-12	19.1	3/4	133	72	26	38
K17V4-16-12	19	3/4	-12	19.1	1	133	72	26	45
K4FV4-20-12	19	3/4	-12	19.1	1 1/4	133	71	25	51
K17V4-16-16	25	1	-16	25.4	1	160	87	32	45
K4FV4-20-16	25	1	-16	25.4	1 1/4	160	87	32	51
K17V6-16-20	31	1 1/4	-20	31.8	1	188	97	38	44
K17V4-16-20	31	1 1/4	-20	31.8	1	198	109.7	38	45
K4FV6-20-20	31	1 1/4	-20	31.8	1 1/4	188	97	38	51
K4FV4-20-20	31	1 1/4	-20	31.8	1 1/4	198	109.7	38	51
K4FV6-24-20	31	1 1/4	-20	31.8	1 1/2	188	97	38	60
K4FV4-24-20	31	1 1/4	-20	31.8	1 1/2	198	109.7	38	60
K4FV6-20-24	38	1 1/2	-24	38.1	1 1/4	201	105	44	51
K4FV6-24-24	38	1 1/2	-24	38.1	1 1/2	221	125	44	60
K4FV4-24-24	38	1 1/2	-24	38.1	1 1/2	222	128.9	44	60
K4FV6-32-24	38	1 1/2	-24	38.1	2	221	125	44	71
K4FV4-32-24	38	1 1/2	-24	38.1	2	222	128.9	44	71
K4FV4-32-32	51	2	-32	50.8	2	269	171	62	71
K4FV6-32-32	51	2	-32	50.8	2	280	169	62	71

Approved fitting series for hose types:



Also available in stainless steel. Details can be found in CAT 4400.1/UK

<b>V4</b>	-10 up to -16 H31 H31TC H31ST R42 R42TC R42ST   -12 up to -20 R35 R35TC H29   all sizes H29TC H29ST H29RH
<b>V6</b>	-24 up to -48 R35 R35TC RS35TC-48   -20 up to -32 R42 R42ST R42TC

# 19/4N ISO 6162-1 Flange 90° Elbow

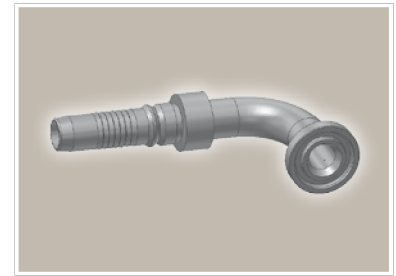
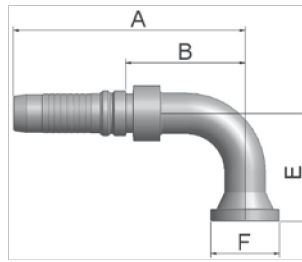
ISO 12151-3-E-L – SFL 90°  
(35.0 MPa/ 5000 psi)



Part Number	 Hose I.D.				 Flange	A	B	E	F
	DN	Inch	Size	mm	Inch	mm	mm	mm	mm
K19V4-12-12	19	3/4	-12	19.1	3/4	125	63.3	58	38
K19V4-16-12	19	3/4	-12	19.1	1	125	63.3	58	45
K19V4-16-16	25	1	-16	25.4	1	150	77.7	70	45
K4NV4-20-16	25	1	-16	25.4	1 1/4	150	77	69	51
K19V4-16-20	31	1 1/4	-20	31.8	1	186	98	90	45
K19V6-16-20	31	1 1/4	-20	31.8	1	177	86	90	44
K4NV6-20-20	31	1 1/4	-20	31.8	1 1/4	177	86	90	51
K4NV4-20-20	31	1 1/4	-20	31.8	1 1/4	186	98.2	90	51
K4NV4-24-20	31	1 1/4	-20	31.8	1 1/2	186	98	90	60
K4NV4-24-20-SL110	31	1 1/4	-20	31.8	1 1/2	186	98	110	60
K4NV6-24-20	31	1 1/4	-20	31.8	1 1/2	177	86	90	60
K4NV6-20-24	38	1 1/2	-24	38.1	1 1/4	184	88	104	51
K4NV4-20-24	38	1 1/2	-24	38.1	1 1/4	197	103	104	51
K4NV6-24-24	38	1 1/2	-24	38.1	1 1/2	209	113	104	60
K4NV4-24-24-SL200	38	1 1/2	-24	38.1	1 1/2	210	116.9	200	60
K4NV4-24-24-SL150	38	1 1/2	-24	38.1	1 1/2	210	116.9	150	60
K4NV4-24-24	38	1 1/2	-24	38.1	1 1/2	210	116.9	104	60
K4NV4-32-24	38	1 1/2	-24	38.1	2	210	116.9	104	71
K4NV6-32-24	38	1 1/2	-24	38.1	2	209	113	104	71
K4NV4-24-32	51	2	-32	50.8	1 1/2	227	130	138	60
K4NV6-32-32	51	2	-32	50.8	2	268	157	138	71
K4NV4-32-32	51	2	-32	50.8	2	257	160.2	138	71

Approved **fitting series** for hose types:

Also available in stainless steel. Details can be found in CAT 4400.1/UK

<b>V4</b>	-10 up to -16	H31	H31TC	H31ST	R42	R42TC	R42ST	-12 up to -20	R35	R35TC	H29	all sizes	H29TC	H29ST	H29RH
<b>V6</b>	-24 up to -48	R35	R35TC	RS35TC-48	-20 up to -32	R42	R42ST	R42TC							

# 6A ISO 6162-2 Flange Straight

ISO 12151-3-S-S – SFS  
(42.0 MPa/ 6000 psi)

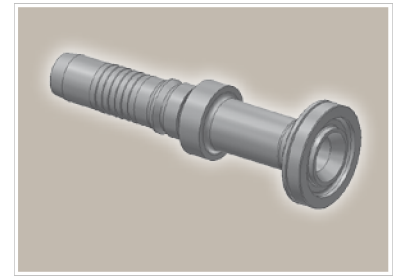
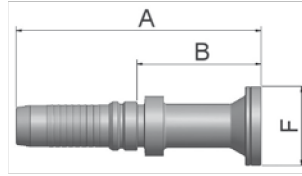

Part Number	Hose I.D.				Flange Inch	A mm	B mm	F mm
	DN	Inch	Size	mm				
K6AV4-8-10	16	5/8	-10	15.9	1/2	121	62	32
K6AV4-12-10	16	5/8	-10	15.9	3/4	94	33.8	41
K6AV4-12-12	19	3/4	-12	19.1	3/4	126	64.4	41
K6AV4-16-12	19	3/4	-12	19.1	1	100	38	48
K6AV4-12-16	25	1	-16	25.4	3/4	150	77	41
K6AV4-16-16	25	1	-16	25.4	1	148	75	48
K6AV4-20-16	25	1	-16	25.4	1 1/4	116	44	54
K6AV4-24-16	25	1	-16	25.4	1 1/2	118	45	64
K6AV6-16-20	31	1 1/4	-20	31.8	1	175	84	48
K6AV4-16-20	31	1 1/4	-20	31.8	1	166	78	48
K6AV4-20-20	31	1 1/4	-20	31.8	1 1/4	166	78	54
K6AV6-20-20	31	1 1/4	-20	31.8	1 1/4	175	83	54
K6AV4-24-20	31	1 1/4	-20	31.8	1 1/2	139	51	64
K6AV6-24-20	31	1 1/4	-20	31.8	1 1/2	147	56	64
K6AV6-20-24	38	1 1/2	-24	38.1	1 1/4	185	89	54
K6AV4-20-24	38	1 1/2	-24	38.1	1 1/4	174	81	54
K6AV4-24-24	38	1 1/2	-24	38.1	1 1/2	192	99	64
K6AV6-24-24	38	1 1/2	-24	38.1	1 1/2	202	106	64
K6AV4-32-24	38	1 1/2	-24	38.1	2	184	91	79
K6AV6-32-24	38	1 1/2	-24	38.1	2	194	98	79
K6AV6-24-32	51	2	-32	50.8	1 1/2	219	108.3	64
K6AV4-24-32	51	2	-32	50.8	1 1/2	198	101	64
K6AV4-32-32	51	2	-32	50.8	2	212	115	79
K6AV6-32-32	51	2	-32	50.8	2	233	122	79
K6AV6-32-40	63	2 1/2	-40	63.5	2	252	117	79
K6AV6-40-40	63	2 1/2	-40	63.5	2 1/2	253	118	108
K6AV6-48-40	63	2 1/2	-40	63.5	3	250	115	132
K6AV6-48-48	76	3	-48	76.2	3	240	133	132

Approved fitting series for hose types:

Also available in stainless steel. Details can be found in CAT 4400.1/UK

<b>V4</b>	-10 up to -16 H31 H31TC H31ST R42 R42TC R42ST   -12 up to -20 R35 R35TC H29   all sizes H29TC H29ST H29RH
<b>V6</b>	-24 up to -48 R35 R35TC RS35TC-48   -20 up to -32 R42 R42ST R42TC

# 6F ISO 6162-2 Flange 45° Elbow – Heavy Series

ISO 12151-3 – E45-S – SFS 45°  
(42.0 MPa/ 6000 psi)

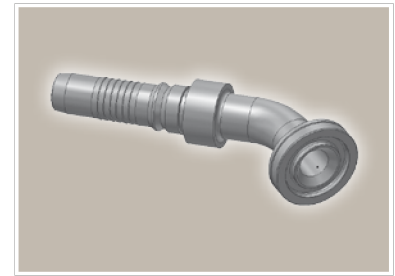
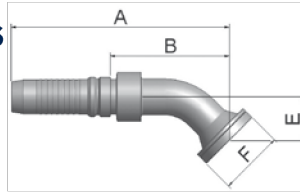

Part Number	Hose I.D.				Flange Inch	A mm	B mm	E mm	F mm
	DN	Inch	Size	mm					
K6FV4-8-10	16	5/8	-10	15.9	1/2	123	63.3	26	32
K6FV4-12-10	16	5/8	-10	15.9	3/4	123	63.3	26	41
K6FV4-12-12	19	3/4	-12	19.1	3/4	133	72	26	41
K6FV4-12-12-SL55	19	3/4	-12	19.1	3/4	162	101	55	41
K6FV4-16-12	19	3/4	-12	19.1	1	133	71.3	26	48
K6FV4-16-12-SL55	19	3/4	-12	19.1	1	162	101	55	48
K6FV4-12-16	25	1	-16	25.4	3/4	155	78	32	41
K6FV4-16-16-SL55	25	1	-16	25.4	1	183	110	55	48
K6FV4-16-16	25	1	-16	25.4	1	160	87	32	48
K6FV4-20-16-SL55	25	1	-16	25.4	1 1/4	184	112	55	54
K6FV4-20-16	25	1	-16	25.4	1 1/4	161	88.7	32	54
K6FV6-16-20	31	1 1/4	-20	31.8	1	188	97	38	48
K6FV4-16-20	31	1 1/4	-20	31.8	1	198	109.7	38	48
K6FV6-20-20	31	1 1/4	-20	31.8	1 1/4	189	97.3	38	54
K6FV4-20-20-SL60	31	1 1/4	-20	31.8	1 1/4	220	132	60	54
K6FV4-20-20	31	1 1/4	-20	31.8	1 1/4	198	109.7	38	54
K6FV6-20-20-SL60	31	1 1/4	-20	31.8	1 1/4	210	119	60	54
K6FV6-24-20	31	1 1/4	-20	31.8	1 1/2	189	97.3	38	64
K6FV4-24-20	31	1 1/4	-20	31.8	1 1/2	198	109.7	38	64
K6FV4-24-20-SL60	31	1 1/4	-20	31.8	1 1/2	220	132	60	64
K6FV6-20-24	38	1 1/2	-24	38.1	1 1/4	209	113.3	44	54
K6FV4-24-24-SL70	38	1 1/2	-24	38.1	1 1/2	248	155	70	64
K6FV6-24-24	38	1 1/2	-24	38.1	1 1/2	221	125.3	44	64
K6FV6-24-24-SL70	38	1 1/2	-24	38.1	1 1/2	247	151	70	64
K6FV4-24-24	38	1 1/2	-24	38.1	1 1/2	222	128.9	44	64
K6FV6-32-24	38	1 1/2	-24	38.1	2	221	125.3	44	79
K6FV4-32-24	38	1 1/2	-24	38.1	2	222	128.9	44	79
K6FV6-24-32	51	2	-32	50.8	1 1/2	260	149.3	56	64
K6FV4-32-32	51	2	-32	50.8	2	263	166	56	79
K6FV6-32-32	51	2	-32	50.8	2	274	163.3	56	79
K6FV4-32-32-SL70	51	2	-32	50.8	2	277	180	70	79

Approved fitting series for hose types:

Also available in stainless steel. Details can be found in CAT 4400.1/UK

<b>V4</b>	-10 up to -16	H31	H31TC	H31ST	R42	R42TC	R42ST	-12 up to -20	R35	R35TC	H29	all sizes	H29TC	H29ST	H29RH
<b>V6</b>	-24 up to -48														
	R35	R35TC	RS35TC-48	-20 up to -32		R42	R42ST	R42TC							

# 6N

## ISO 6162-2 Flange 90° Elbow

ISO 12151-3 – E-S – SFS 90°  
(42.0 MPa/ 6000 psi)

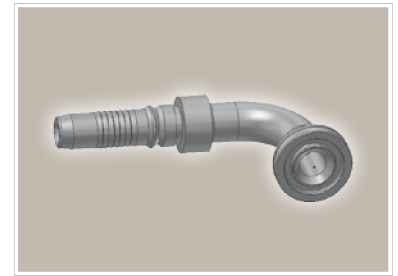
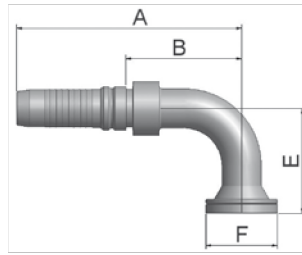

Part Number	Hose I.D.				Flange Inch	A mm	B mm	E mm	F mm
	DN	Inch	Size	mm					
K6NV4-8-10	16	5/8	-10	15.9	1/2	111	51	54	32
K6NV4-12-10	16	5/8	-10	15.9	3/4	111	50.3	54	41
K6NV4-12-12	19	3/4	-12	19.1	3/4	125	63.3	58	41
K6NV4-12-12-SL100	19	3/4	-12	19.1	3/4	125	63	100	41
K6NV4-16-12-SL100	19	3/4	-12	19.1	1	125	63	100	48
K6NV4-16-12	19	3/4	-12	19.1	1	125	63.3	58	48
K6NV4-12-16-SL55	25	1	-16	25.4	3/4	140	67	55	41
K6NV4-12-16	25	1	-16	25.4	3/4	140	67	70	41
K6NV4-16-16-SL100	25	1	-16	25.4	1	150	77	100	48
K6NV4-16-16	25	1	-16	25.4	1	150	77.7	70	48
K6NV4-20-16-SL115	25	1	-16	25.4	1 1/4	154	81	115	54
K6NV4-20-16	25	1	-16	25.4	1 1/4	154	81	70	54
K6NV4-16-20	31	1 1/4	-20	31.8	1	186	98.7	90	48
K6NV6-16-20	31	1 1/4	-20	31.8	1	177	86	90	48
K6NV6-20-20	31	1 1/4	-20	31.8	1 1/4	177	86.3	90	54
K6NV4-20-20-SL120	31	1 1/4	-20	31.8	1 1/4	186	98	120	54
K6NV6-20-20-SL120	31	1 1/4	-20	31.8	1 1/4	177	86	120	54
K6NV4-20-20	31	1 1/4	-20	31.8	1 1/4	186	98.7	90	54
K6NV4-20-20-SL330	31	1 1/4	-20	31.8	1 1/4	186	98	330	54
K6NV4-24-20	31	1 1/4	-20	31.8	1 1/2	186	98.7	90	64
K6NV6-24-20	31	1 1/4	-20	31.8	1 1/2	177	86.3	90	64
K6NV4-24-20-SL135	31	1 1/4	-20	31.8	1 1/2	186	98	135	64
K6NV6-20-24	38	1 1/2	-24	38.1	1 1/4	192	96.3	104	54
K6NV4-20-24	38	1 1/2	-24	38.1	1 1/4	197	103.9	104	54
K6NV4-24-24-SL140	38	1 1/2	-24	38.1	1 1/2	210	117	140	64
K6NV4-24-24-SL160	38	1 1/2	-24	38.1	1 1/2	210	117	160	64
K6NV4-24-24-SL200	38	1 1/2	-24	38.1	1 1/2	210	117	200	64
K6NV4-24-24	38	1 1/2	-24	38.1	1 1/2	210	116.9	104	64
K6NV6-24-24	38	1 1/2	-24	38.1	1 1/2	210	113.3	104	64
K6NV6-32-24	38	1 1/2	-24	38.1	2	209	113.3	104	79
K6NV4-32-24	38	1 1/2	-24	38.1	2	210	116.9	104	79
K6NV6-24-32	51	2	-32	50.8	1 1/2	236	125.3	104	64
K6NV4-24-32	51	2	-32	50.8	1 1/2	221	124	104	64
K6NV4-32-32	51	2	-32	50.8	2	257	160	138	79
K6NV6-32-32	51	2	-32	50.8	2	268	157.3	138	79

V4/V6 Series

Approved fitting series for hose types:

Also available in stainless steel. Details can be found in CAT 4400.1/UK

<b>V4</b>	-10 up to -16 H31 H31TC H31ST R42 R42TC R42ST   -12 up to -20 R35 R35TC H29   all sizes H29TC H29ST H29RH
<b>V6</b>	-24 up to -48 R35 R35TC RS35TC-48   -20 up to -32 R42 R42ST R42TC

## 8A Flange – Straight

8000 psi

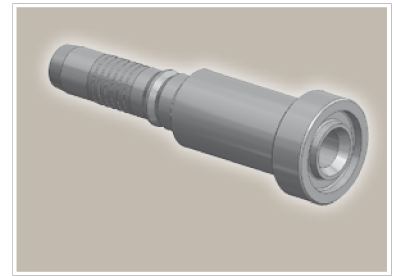
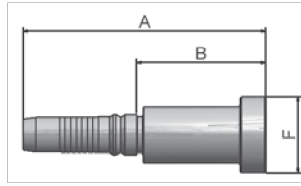

Part Number	Hose I.D.				Flange Inch	A mm	B mm	F mm
	DN	Inch	Size	mm				
K8AV4-12-10	16	5/8	-10	15.9	3/4	130	71	41
K8AV4-12-12	19	3/4	-12	19.1	3/4	132	71	41
K8AV4-16-12	19	3/4	-12	19.1	1	143	82	48
K8AV4-16-16	25	1	-16	25.4	1	148	75	48
K8AV4-20-16	25	1	-16	25.4	1 1/4	111	39	54
K8AV6-20-20	31	1 1/4	-20	31.8	1 1/4	190	88	54

## 8F Flange – 45° Elbow

8000 psi

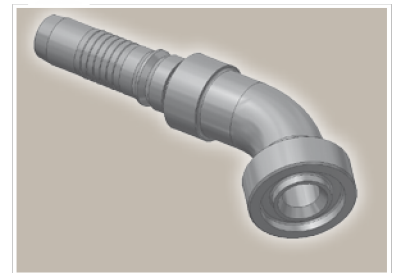
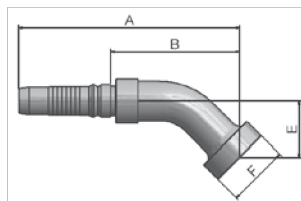

Part Number	Hose I.D.				Flange Inch	A mm	B mm	E mm	F mm
	DN	Inch	Size	mm					
K8FV4-12-10	16	5/8	-10	15.9	3/4	123	64	26	41
K8FV4-12-12	19	3/4	-12	19.1	3/4	138	76	26	41
K8FV4-16-12	19	3/4	-12	19.1	1	143	81	32	48
K8FV4-16-16	25	1	-16	25.4	1	178	105	35	48
K8FV4-20-16	25	1	-16	25.4	1 1/4	178	105	35	54
K8FV6-20-20	31	1 1/4	-20	31.8	1 1/4	194	103	38	54

Approved **fitting series** for hose types:

Also available in stainless steel. Details can be found in CAT 4400.1/UK

<b>V4</b>	-10 up to -16	H31	H31TC	H31ST	R42	R42TC	R42ST	-12 up to -20	R35	R35TC	H29	all sizes	H29TC	H29ST	H29RH
<b>V6</b>	-24 up to -48														
	R35	R35TC	RS35TC-48	-20 up to -32		R42	R42ST	R42TC							

# 8N Flange – 90° Elbow

8000 psi

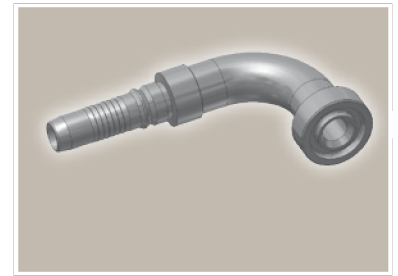
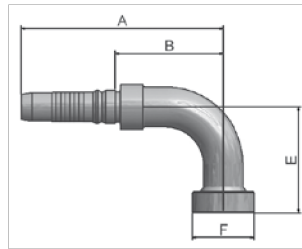

Part Number	Hose I.D.				Flange Inch	A mm	B mm	E mm	F mm
	DN	Inch	Size	mm					
K8NV4-12-10	16	5/8	-10	15.9	3/4	111	51	58	41
K8NV4-12-12	19	3/4	-12	19.1	3/4	133	71	70	41
K8NV4-16-12	19	3/4	-12	19.1	1	133	71	70	48
K8NV4-16-16	25	1	-16	25.4	1	170	97	75	48
K8NV4-20-16	25	1	-16	25.4	1 1/4	170	97	90	54
K8NV6-20-20	31	1 1/4	-20	31.8	1 1/4	182	91	90	54

# X5 Flange – Straight

Full flange system for  
ISO 6162-1 or ISO 6162-2

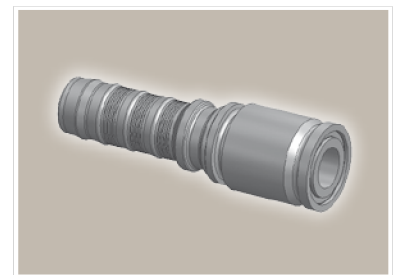
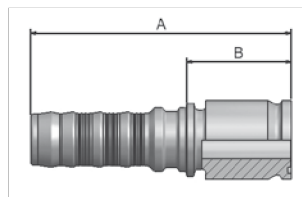

Part Number	Hose I.D.				Flange Inch	A mm	B mm
	DN	Inch	Size	mm			
KX5V6-20-20	31	1 1/4	-20	31.8	1 1/4	152.3	61.3
KX5V6-24-24	38	1 1/2	-24	38.1	1 1/2	159.3	63.3
KX5V6-32-32	51	2	-32	50.8	2	188	78
KX5V6-40-40	63	2 1/2	-40	63.5	2 1/2	233	83
KX5V6-48-40	63	2 1/2	-40	63.5	3	233	98
KX5V6-48-48	76	3	-48	76.2	3	200	84

Approved fitting series for hose types:



Also available in stainless steel. Details can be found in CAT 4400.1/UK

<b>V4</b>	-10 up to -16 H31 H31TC H31ST R42 R42TC R42ST   -12 up to -20 R35 R35TC H29   all sizes H29TC H29ST H29RH
<b>V6</b>	-24 up to -48 R35 R35TC RS35TC-48   -20 up to -32 R42 R42ST R42TC

## X7 Flange – 45° Elbow

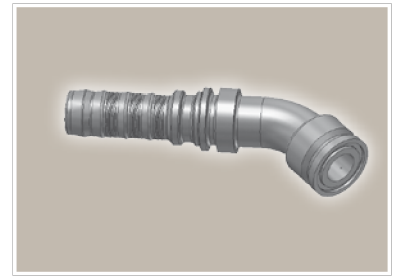
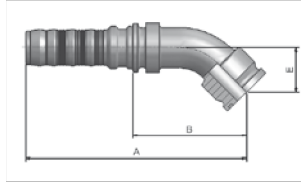
Full flange system for  
ISO 6162-1 or ISO 6162-2





Part Number	 Hose I.D.				 Flange	A	B	E
	DN	Inch	Size	mm	Inch	mm	mm	mm
KX7V6-20-20	31	1 1/4	-20	31.8	1 1/4	190	99	39
KX7V6-24-24	38	1 1/2	-24	38.1	1 1/2	221	125	44
KX7V6-32-32	51	2	-32	50.8	2	275	164.5	57

## X9 Flange – 90° Elbow

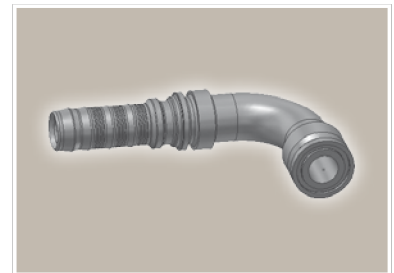
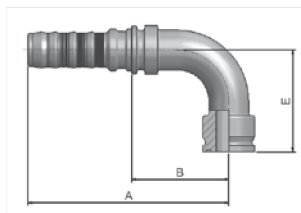
Full flange system for  
ISO 6162-1 or ISO 6162-2



Part Number	 Hose I.D.				 Flange	A	B	E
	DN	Inch	Size	mm	Inch	mm	mm	mm
KX9V6-20-20	31	1 1/4	-20	31.8	1 1/4	176.8	85.5	90
KX9V6-24-24	38	1 1/2	-24	38.1	1 1/2	209.3	113	104
KX9V6-32-32	51	2	-32	50.8	2	268	157	138

Approved **fitting series** for hose types:

Also available in stainless steel. Details can be found in CAT 4400.1/UK

<b>V4</b>	-10 up to -16	H31	H31TC	H31ST	R42	R42TC	R42ST	-12 up to -20	R35	R35TC	H29	all sizes	H29TC	H29ST	H29RH
<b>V6</b>	-24 up to -48														
	R35	R35TC	RS35TC-48	-20 up to -32		R42	R42ST	R42TC							



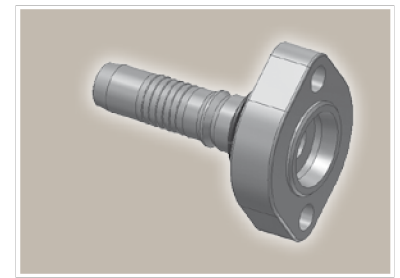
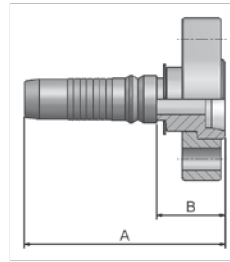

**PY** Flange – 24° Male  
French Gas  
Straight

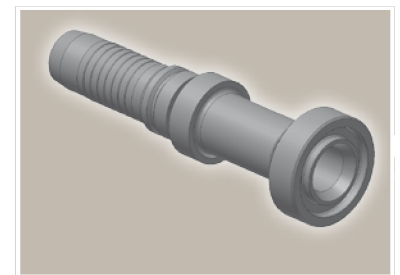
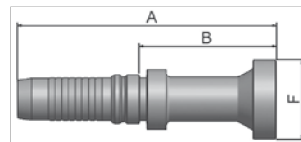

Part Number	 Hose I.D.				A mm	B mm
	DN	Inch	Size	mm		
KPYV4-12-12	19	3/4	-12	19.1	92	30
KPYV4-16-16	25	1	-16	25.4	112	39

**XA** Caterpillar® Flange  
Straight



Part Number	 Hose I.D.				 Flange Inch	A mm	B mm	F mm
	DN	Inch	Size	mm				
KXAV4-12-12	19	3/4	-12	19.1	3/4	132	71	41
KXAV4-16-12	19	3/4	-12	19.1	1	144	82	48
KXAV4-16-16	25	1	-16	25.4	1	155	82	48
KXAV4-20-16	25	1	-16	25.4	1 1/4	160	88	54
KXAV6-20-20	31	1 1/4	-20	31.8	1 1/4	181	90	54
KXAV6-24-20	31	1 1/4	-20	31.8	1 1/2	188	97	64
KXAV6-24-24	38	1 1/2	-24	38.1	1 1/2	207	111	64

Approved fitting series for hose types:

Also available in stainless steel. Details can be found in CAT 4400.1/UK

<b>V4</b>	-10 up to -16 H31 H31TC H31ST R42 R42TC R42ST   -12 up to -20 R35 R35TC H29   all sizes H29TC H29ST H29RH
<b>V6</b>	-24 up to -48 R35 R35TC RS35TC-48   -20 up to -32 R42 R42ST R42TC

**XF** Caterpillar® Flange  
45° Elbow

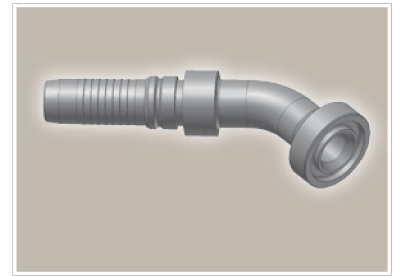
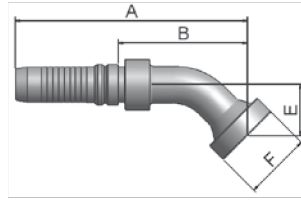

Part Number	Hose I.D.				Flange Inch	A mm	B mm	E mm	F mm
	DN	Inch	Size	mm					
KXFV4-12-12	19	3/4	-12	19.1	3/4	138	76	31	41
KXFV4-16-16	25	1	-16	25.4	1	164	91	36	48
KXFV4-20-16	25	1	-16	25.4	1 1/4	164	92	35	54
KXFV6-20-20	31	1 1/4	-20	31.8	1 1/4	187	96	37	54
KXFV6-24-20	31	1 1/4	-20	31.8	1 1/2	187	96	37	64
KXFV6-24-24	38	1 1/2	-24	38.1	1 1/2	216	120	39	64

**XG** Caterpillar® Flange  
60° Elbow

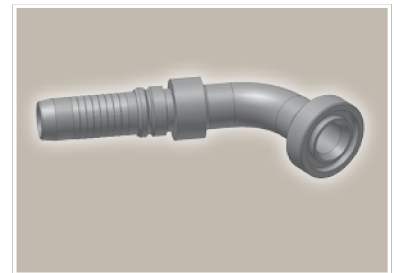
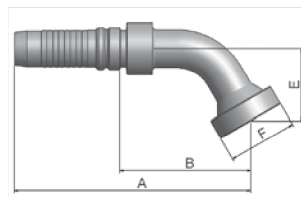

Part Number	Hose I.D.				Flange Inch	A mm	B mm	E mm	F mm
	DN	Inch	Size	mm					
KXGV4-16-12	19	3/4	-12	19.1	1	152	91	42	48
KXGV4-16-16	25	1	-16	25.4	1	182	109	50	48
KXGV4-20-16	25	1	-16	25.4	1 1/4	184	112	50	54
KXGV6-20-20	31	1 1/4	-20	31.8	1 1/4	206	115	55	54
KXGV6-24-20	31	1 1/4	-20	31.8	1 1/2	208	117	52	64
KXGV6-24-24	38	1 1/2	-24	38.1	1 1/2	266	170	52	64



Approved **fitting series** for hose types:

Also available in stainless steel. Details can be found in CAT 4400.1/UK

<b>V4</b>	-10 up to -16	H31	H31TC	H31ST	R42	R42TC	R42ST	-12 up to -20	R35	R35TC	H29	all sizes	H29TC	H29ST	H29RH
<b>V6</b>	-24 up to -48														
	R35	R35TC	RS35TC-48	-20 up to -32		R42	R42ST	R42TC							

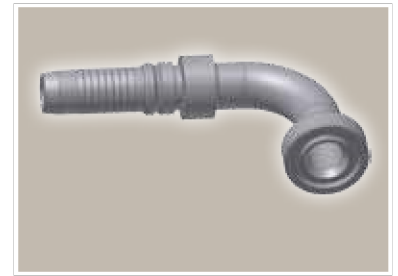
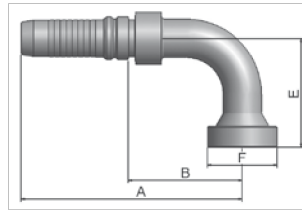
# XN Caterpillar® Flange 90° Elbow



Part Number	 Hose I.D.				 Flange	A mm	B mm	E mm	F mm
	DN	Inch	Size	mm	Inch				
KXNV4-12-12	19	3/4	-12	19.1	3/4	125	63	63	41
KXNV4-16-12	19	3/4	-12	19.1	1	125	63	62	48
KXNV4-16-16	25	1	-16	25.4	1	150	77	74	48
KXNV4-20-16	25	1	-16	25.4	1 1/4	154	81	74	54
KXNV6-20-20	31	1 1/4	-20	31.8	1 1/4	177	86	77	54
KXNV6-24-20	31	1 1/4	-20	31.8	1 1/2	177	86	77	64
KXNV6-24-24	38	1 1/2	-24	38.1	1 1/2	209	113	106	64

Approved **fitting series** for hose types:

Also available in stainless steel. Details can be found in CAT 4400.1/UK

<b>V4</b>	-10 up to -16   H31   H31TC   H31ST   R42   R42TC   R42ST   -12 up to -20   R35   R35TC   H29   all sizes   H29TC   H29ST   H29RH
<b>V6</b>	-24 up to -48   R35   R35TC   RS35TC-48   -20 up to -32   R42   R42ST   R42TC

## JC Female ORFS Swivel – Straight Short

ISO 12151-1 – SWSA  
SAE J516 – ORFS

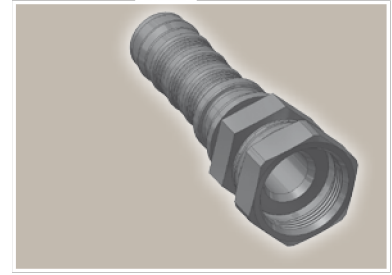
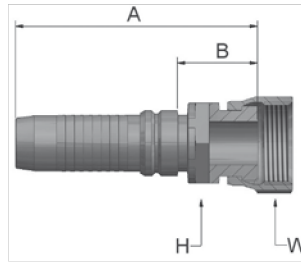

Part Number	Hose I.D.				Thread UNF	A mm	B mm	H mm	W mm
	DN	Inch	Size	mm					
KJCV4-12-12	19	3/4	-12	19.1	1 3/16x12	93	31.3	30	36
KJCV4-16-12	19	3/4	-12	19.1	1 7/16x12	93	31	36	41
KJCV4-12-16	25	1	-16	25.4	1 3/16x12	101	29	36	36
KJCV4-16-16	25	1	-16	25.4	1 7/16x12	108	36	36	41
KJCV4-20-16	25	1	-16	25.4	1 11/16x12	120	47	41	50
KJCV6-20-20	31	1 1/4	-20	31.8	1 11/16x12	132	41	46	50
KJCV4-20-20	31	1 1/4	-20	31.8	1 11/16x12	127	39	46	50
KJCV6-24-20	31	1 1/4	-20	31.8	2x12	133	42	50	60
KJCV6-24-24	38	1 1/2	-24	38.1	2x12	140	44	50	60
KJCV4-24-24	38	1 1/2	-24	38.1	2x12	131	37.9	50	60

## JS ORFS Swivel Female (Long)

ISO 12151-1-SWSB  
SAE J516 – ORFS

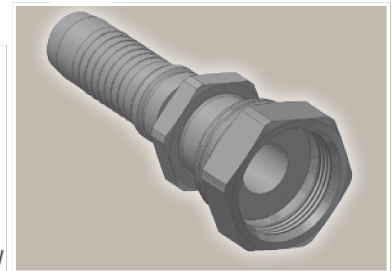
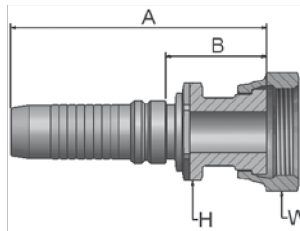

Part Number	Hose I.D.				Thread UNF	A mm	B mm	H mm	W mm
	DN	Inch	Size	mm					
KJSV4-16-16	25	1	-16	25.4	1 7/16x12	121	49	36	41
KJSV4-20-16	25	1	-16	25.4	1 11/16x12	120	47.7	41	50
KJSV4-20-20	31	1 1/4	-20	31.8	1 11/16x12	137	49.7	41	50

Approved **fitting series** for hose types:

Also available in stainless steel. Details can be found in CAT 4400.1/UK

<b>V4</b>	-10 up to -16	H31	H31TC	H31ST	R42	R42TC	R42ST	-12 up to -20	R35	R35TC	H29	all sizes	H29TC	H29ST	H29RH
<b>V6</b>	-24 up to -48														
	R35	R35TC	RS35TC-48	-20 up to -32			R42	R42ST	R42TC						

## J7 Female ORFS – Swivel 45° Elbow

ISO 12151-1 – SWE 45°  
SAE J516 – ORFS 45°

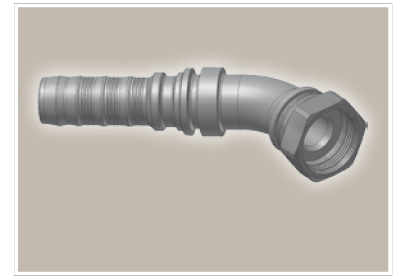
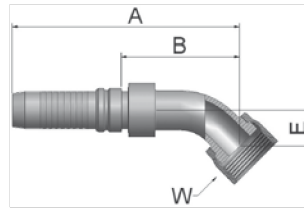

Part Number	Hose I.D.				Thread UNF	A mm	B mm	E mm	W mm
	DN	Inch	Size	mm					
KJ7V4-12-12	19	3/4	-12	19.1	1 3/16x12	128	66.3	21	36
KJ7V4-16-12	19	3/4	-12	19.1	1 7/16x12	131	70	24	41
KJ7V4-16-16	25	1	-16	25.4	1 7/16x12	152	79	24	41
KJ7V4-20-16	25	1	-16	25.4	1 11/16x12	154	81	26	50
KJ7V4-20-20	31	1 1/4	-20	31.8	1 11/16x12	189	101.7	30	50
KJ7V6-20-20	31	1 1/4	-20	31.8	1 11/16x12	179	87.8	33	50
KJ7V6-24-20	31	1 1/4	-20	31.8	2x12	190	99	40	60
KJ7V6-24-24	38	1 1/2	-24	38.1	2x12	216	120	40	60
KJ7V4-24-24	38	1 1/2	-24	38.1	2x12	218	124.9	40	60

## J9 Female ORFS – Swivel 90° Elbow – Short Drop

ISO 12151-1 – SWES  
SAE J516 – ORFS 90°

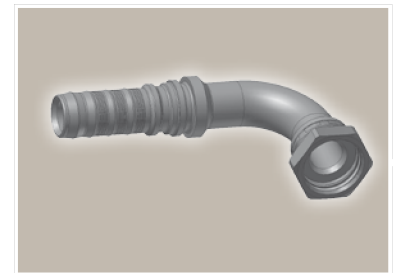
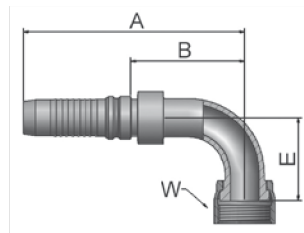

Part Number	Hose I.D.				Thread UNF	A mm	B mm	E mm	W mm
	DN	Inch	Size	mm					
KJ9V4-12-12	19	3/4	-12	19.1	1 3/16x12	125	63.3	48	36
KJ9V4-16-12	19	3/4	-12	19.1	1 7/16x12	125	63	56	41
KJ9V4-16-16	25	1	-16	25.4	1 7/16x12	150	77.7	56	41
KJ9V4-20-16	25	1	-16	25.4	1 11/16x12	150	77	64	50
KJ9V4-20-20	31	1 1/4	-20	31.8	1 11/16x12	186	98	69	50
KJ9V6-20-20	31	1 1/4	-20	31.8	1 11/16x12	177	86	79	50
KJ9V6-24-20	31	1 1/4	-20	31.8	2x12	177	86	70	60
KJ9V6-24-24	38	1 1/2	-24	38.1	2x12	202	106	87	60
KJ9V4-24-24	38	1 1/2	-24	38.1	2x12	210	116.9	82	60

Approved fitting series for hose types:

Also available in stainless steel. Details can be found in CAT 4400.1/UK

<b>V4</b>	-10 up to -16 H31 H31TC H31ST R42 R42TC R42ST   -12 up to -20 R35 R35TC H29   all sizes H29TC H29ST H29RH
<b>V6</b>	-24 up to -48 R35 R35TC RS35TC-48   -20 up to -32 R42 R42ST R42TC

**JM**

**ORFS Male**

ISO 12151-1-S – SAE J516

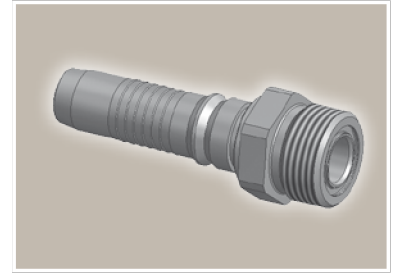
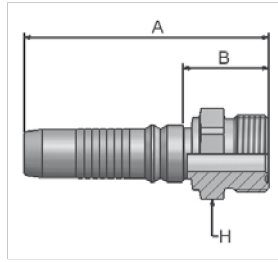

Part Number	Hose I.D.				Thread UNF	A mm	B mm	H mm
	DN	Inch	Size	mm				
KJMV4-12-12	19	3/4	-12	19.1	1 3/16x12	95	33.3	32
KJMV4-16-12	19	3/4	-12	19.1	1 7/16x12	98.7	37	41

Approved **fitting series** for hose types:

Also available in stainless steel. Details can be found in CAT 4400.1/UK

<b>V4</b>	-10 up to -16	H31	H31TC	H31ST	R42	R42TC	R42ST	-12 up to -20	R35	R35TC	H29	all sizes	H29TC	H29ST	H29RH		
<b>V6</b>	-24 up to -48																
	R35	R35TC	RS35TC-48	-20 up to -32											R42	R42ST	R42TC

## FG Male French Gas Series Rigid – Straight (24° Cone)

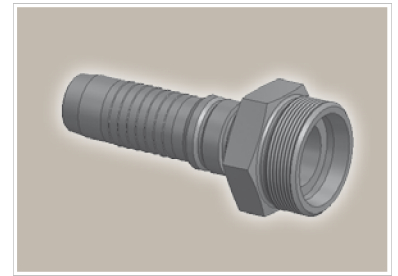
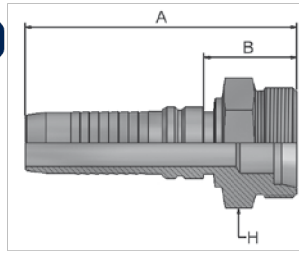

Part Number	Hose I.D.				Thread metric	Tube O.D. mm	A mm	B mm	H mm
	DN	Inch	Size	mm					
KFGV4-27-12	19	3/4	-12	19.1	M36x1.5	26.75	94	32.3	36
KFGV4-33-16	25	1	-16	25.4	M45x1.5	33.5	111	38.7	46

## F4 Female French Gas Series Swivel – Straight (Ball Nose)

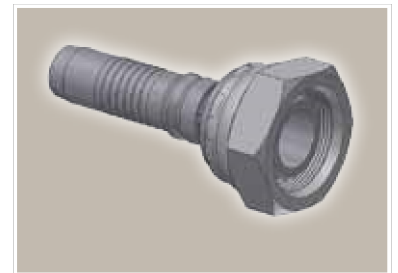
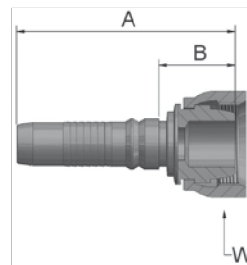

Part Number	Hose I.D.				Thread metric	Tube O.D. mm	A mm	B mm	W mm
	DN	Inch	Size	mm					
KF4V4-27-12	19	3/4	-12	19.1	M36x1.5	26.75	95	33	46

Approved **fitting series** for hose types:

Also available in stainless steel. Details can be found in CAT 4400.1/UK

<b>V4</b>	-10 up to -16	H31	H31TC	H31ST	R42	R42TC	R42ST	-12 up to -20	R35	R35TC	H29	all sizes	H29TC	H29ST	H29RH
<b>V6</b>	-24 up to -48														
	R35	R35TC	RS35TC-48	-20 up to -32			R42	R42ST	R42TC						

## Shell

Page Dg-1

**V5**

Dg-1



**Interlock  
In-/Outside Skive**  
R56TC Hose

## DIN – Metric

Page Dg-2 – Dg-3

**C9**

Dg-2

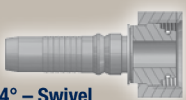

**Female Metric 24° – Swivel  
Heavy Series with O-Ring  
Straight**  
ISO 12151-2-SWS-S – DKOS

**0C**

Dg-2

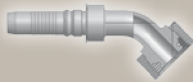

**Female Metric 24° – Swivel  
Heavy Series with O-Ring  
45° Elbow**  
ISO 12151-2-SWE 45°-S – DKOS 45°

**1C**

Dg-3



**Female Metric 24° – Swivel  
Heavy Series with O-Ring  
90° Elbow**  
ISO 12151-2-SWE-S – DKOS 90°



# V5

## Interlock In-/Outside Skive

R56TC Hose

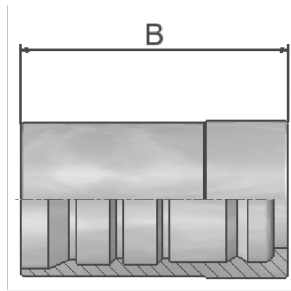

Only for use with  
adjustable crimpers.

Part Number	 Hose I.D.				B mm
	DN	Inch	Size	mm	
100V5-6	10	3/8	-6	9.5	47
100V5-8	12	1/2	-8	12.7	53

Approved **fitting series** for hose types:



## C9 Female Metric 24° – Swivel Heavy Series with O-Ring Straight

ISO 12151-2-SWS-S – DKOS

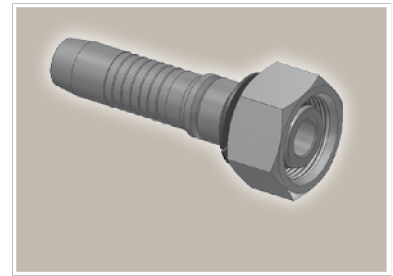
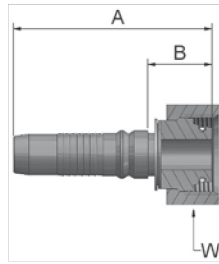

Part Number	Hose I.D.				Thread metric	Tube O.D. mm	A mm	B mm	W mm
	DN	Inch	Size	mm					
KC9V5-14-6	10	3/8	-6	9.5	M22x1.5	14	72	23	27
KC9V5-16-8	12	1/2	-8	12.7	M24x1.5	16	79	26	30

Fittings with standard O-ring seals can be used for temperatures from -40 °C up to +105 °C.  
O-rings see section Eb. Special O-rings are available on request.

## OC Female Metric 24° – Swivel Heavy Series with O-Ring 45° Elbow

ISO 12151-2 – SWE 45°-S – DKOS 45°

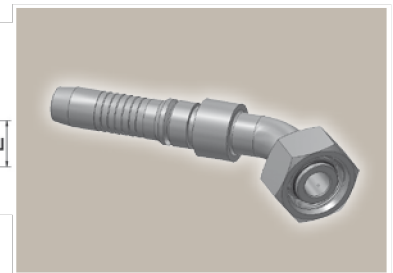
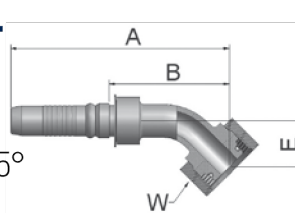

Part Number	Hose I.D.				Thread metric	Tube O.D. mm	A mm	B mm	E mm	W mm
	DN	Inch	Size	mm						
KOCV5-14-6	10	3/8	-6	9.5	M22x1.5	14	102	53	20	27
KOCV5-16-8	12	1/2	-8	12.7	M24x1.5	16	112	60	24	30

Fittings with standard O-ring seals can be used for temperatures from -40 °C up to +105 °C.  
O-rings see section Eb. Special O-rings are available on request.

Approved **fitting series** for hose types:

V5 | R56TC |

# 1C Female Metric 24° – Swivel Heavy Series with O-Ring 90° Elbow

ISO 12151-2-SWE-S – DKOS 90°

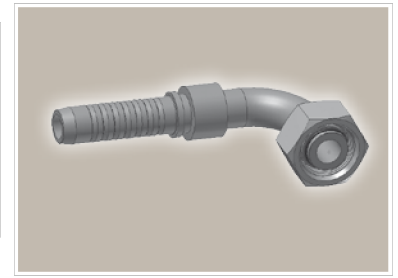
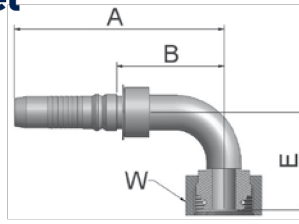

Part Number	Hose I.D.				Thread metric	Tube O.D. mm	A mm	B mm	E mm	W mm
	DN	Inch	Size	mm						
K1CV5-14-6	10	3/8	-6	9.5	M22x1.5	14	91	42	37	27
K1CV5-16-8	12	1/2	-8	12.7	M24x1.5	16	101	48	45	30

Fittings with standard O-ring seals can be used for temperatures from -40 °C up to +105 °C.  
O-rings see section Eb. Special O-rings are available on request.

Approved **fitting series** for hose types:



## Shell

Page Dh-1

**100WB**

Dh-1

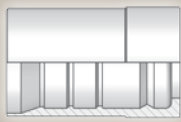

**Interlock  
In-/Outside Skive**  
BPK Hose

## DIN – Metric

Page Dh-2

**C9**

Dh-2



**Female Metric 24° – Swivel  
Heavy Series with O-Ring  
Straight**  
ISO 12151-2-SWS-S – DKOS

## BSP

Page Dh-3

**92**

Dh-3

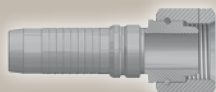

**Female BSP Parallel Pipe  
Swivel – Straight (60° Cone)**  
BS5200-A – DKR

## SAE

Page Dh-4

**01**

Dh-4

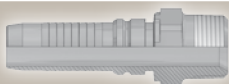

**Male NPTF Pipe  
Rigid – Straight**  
SAE J476A / J516 – AGN

# 100WB Interlock In-/Outside Skive

BPK Hose

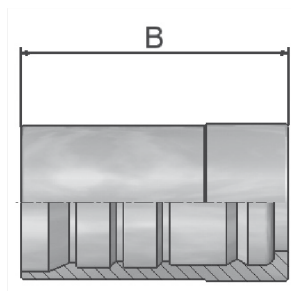

Only for use with  
adjustable crimpers.

Part Number	 Hose I.D.				B mm
	DN	Inch	Size	mm	
100WB-4	6	1/4	-4	6.3	55.0
100WB-6	10	3/8	-6	9.5	47.0
100WB-8	12	1/2	-8	12.7	52.5
100WB-12	20	3/4	-12	19.1	61.0
100WB-16	25	1	-16	25.4	74.5

Approved **fitting series** for hose types:



## C9 Female Metric 24° – Swivel Heavy Series with O-Ring Straight

ISO 12151-2-SWS-S – DKOS

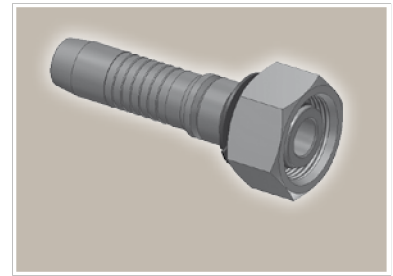
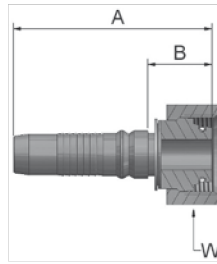

Part Number	Hose I.D.				Thread metric	Tube O.D. mm	A mm	B mm	W mm
	DN	Inch	Size	mm					
KC9WB-10-4	6	1/4	-4	6.3	M18x1.5	10	72	21	22
KC9WB-14-6	10	3/8	-6	9.5	M22x1.5	14	72	23	27
KC9WB-16-8	12	1/2	-8	12.7	M24x1.5	16	85	32	30
KC9WB-25-12	20	3/4	-12	19.1	M36x2	25	95	34	46
KC9WB-30-16	25	1	-16	25.4	M42x2	30	108	36	50

Fittings with standard O-ring seals can be used for temperatures from -40 °C up to +105 °C.  
O-rings see section Eb. Special O-rings are available on request.

Approved **fitting series** for hose types:

**WB** | **BPK**

92

**Female BSP Parallel Pipe  
Swivel – Straight (60° Cone)**

BS5200-A – DKR

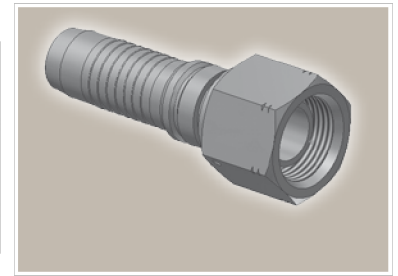
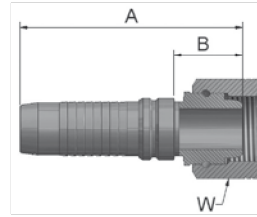

Part Number	Hose I.D.				Thread BSP	A mm	B mm	W mm
	DN	Inch	Size	mm				
K92WB-4-4	6	1/4	-4	6.3	1/4x19	70	19	19
K92WB-6-6	10	3/8	-6	9.5	3/8x19	72	23	22
K92WB-8-8	12	1/2	-8	12.7	1/2x14	79	26	27

Approved **fitting series** for hose types:



# 01

## Male NPTF Pipe Rigid – Straight

SAE J476A / J516 – AGN

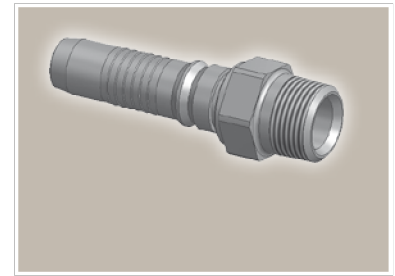
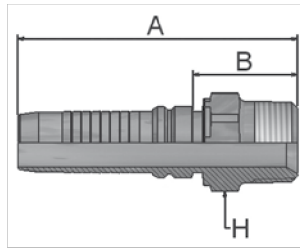

Part Number	Hose I.D.				Thread NPTF	A mm	B mm	H mm
	DN	Inch	Size	mm				
K01WB-4-4	6	1/4	-4	6.3	1/4x18	79	28	14
K01WB-6-4	6	1/4	-4	6.3	3/8x18	82	31	19
K01WB-6-6	10	3/8	-6	9.5	3/8x18	77	28	19
K01WB-8-8	12	1/2	-8	12.7	1/2x14	90	37	22
K01WB-12-12	20	3/4	-12	19.1	3/4x14	98	36	30
K01WB-16-16	25	1	-16	25.4	1x11-1/2	114	41	36

Approved **fitting series** for hose types:

**WB** | **BPK**