

Fittings, Tubing & Nipples

High Pressure

Pressures to 150,000 psi (10342 bar)

Since 1945 Autoclave Engineers has designed and built premium quality valves, fittings and tubing. This commitment to engineering and manufacturing excellence has earned Autoclave a reputation for reliable, efficient product performance. Autoclave Engineers has long been established as the world leader in high pressure fluid handling components for the chemical/petrochemical, research, and oil and gas, waterjet, and waterblast industries.



High Pressure Fittings, Tubing and Nipples Features:

- Coned-and-Threaded Connection.
- Available sizes are 1/4, 5/16, 3/8, 9/16, and 1”.
- Fittings and tubing manufactured from 316 cold worked stainless steel.
- Operating Temperatures from -423°F (-252°C) to 1200°F (649°C).
- Anti-vibration connection components available.
- Ultra-high pressure components.
- Autofrettaged tubing.
- High pressure high cycle tubing.

The high and ultra-high pressure series uses Autoclave’s high pressure connector. This coned-and-threaded connection provides dependable performance in gas or liquid service.

**Autoclave
Engineers** 

Fluid Components
Division of Snap-tite, Inc.
www.autoclave.com

Fittings, Tubing & Nipples - High Pressure

High Pressure Fittings

Pressures to 150,000 psi (10342 bar)

Autoclave Engineers high pressure fittings Series F and SF are the industry standard for pressures to 150,000 psi (10342 bar). Utilizing Autoclave Engineers high pressure coned-and-threaded connections, these fittings are correlated with Series 30VM, 30SC, 40VM, 60VM, 100V, and 150V valves and Autoclave Engineers high pressure tubing.

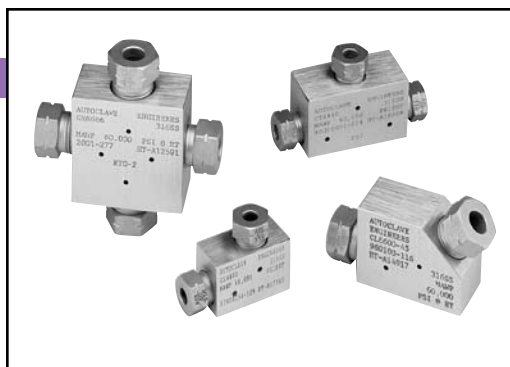

Connection Components

All Autoclave Engineers valves and fittings are supplied complete with appropriate glands and collars. To order these components separately, use order numbers listed. When using plug, collar is not required.

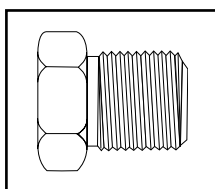

Gland
AGL ()

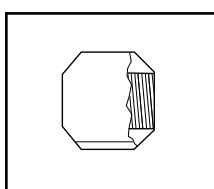

Collar
ACL ()

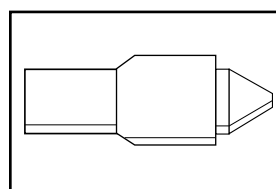

Plug
AP ()

Add tube size ()

- 1/4" - 40
- 5/16" - 50
- 3/8" - 60
- 9/16" - 90
- 1" - 160

Example:

9/16" Gland - AGL (90)

To ensure proper fit use Autoclave Engineers tubing.

Note: Special material glands may be supplied with four flats in place of standard hex.

Connection Type	Gland	Collar	Plug	Connection Components (Industry Standard)
F250C F375C F562C	AGL()	ACL()	AP()	Autoclave Engineer's high pressure fittings 1/4, 3/8 and 9/16 connection components to 60,000 psi (4137 bar). For use with 30VM, 40VM, 60VM valves and fittings.
F1000C43	CGLX160	CCLX160	43CP160	Autoclave Engineer's high pressure 1" connection components to 43,000 psi (2965 bar) for use with 30SC, 43Y valves, and fittings.
F312C150	CGL50	CCL50	CP50	Autoclave Engineer's ultra high pressure 5/16 connection components to 150,000 psi (10342 bar) for use with 100VM and 150V valve and fittings.
	100CGL40 100CGL60	100CCL40 100CCL60	100CP40 100CP60	Autoclave Engineer's 100,000 psi (6895 bar) connection components utilize our 5/16" connection for 1/4" and 3/8" tubing. (See Note*)

Catalog Number	Connection Type	Outside Diameter Tube	Pressure Rating psi (bar)*	Minimum Opening	Dimensions - inches (mm)							Block Thickness	Fitting Pattern
					A	B	C	D Typical	E	F	G Thickness		

Elbow

CL4400	F250C	1/4 (6.35)	60,000 (4136.79)	0.094 (2.39)	1.00 (25.40)	1.50 (38.10)	0.50 (12.70)	0.63 (15.88)	0.62 (15.75)	0.88 (22.35)		0.75 (19.05)	See Figure 1
100CL4400	F312C150	1/4 (6.35)	100,000 (6894.65)	0.094 (2.39)	2.12 (53.85)	3.00 (76.20)	0.52 (13.21)	0.75 (19.05)	1.50 (38.10)	1.50 (38.10)		1.38 (35.05)	
CL5500	F312C150	5/16 (7.94)	150,000 (10341.97)	0.094 (2.39)	2.12 (53.85)	3.00 (76.20)	0.52 (13.21)	0.75 (19.05)	1.50 (38.10)	1.50 (38.10)		1.38 (35.05)	
CL6600	F375C	3/8 (9.53)	60,000 (4136.79)	0.125 (3.18)	1.50 (38.10)	2.00 (50.80)	0.52 (13.21)	0.81 (20.62)	1.00 (25.40)	1.25 (31.75)		1.00 (25.40)	
100CL6600	F312C150	3/8 (9.53)	100,000 (6894.65)	0.094 (2.39)	2.12 (53.85)	3.00 (76.20)	0.52 (13.21)	0.75 (19.05)	1.50 (38.10)	1.50 (38.10)		1.38 (35.05)	
CL9900	F562C	9/16 (14.29)	60,000 (4136.79)	0.188 (4.78)	1.88 (47.75)	2.62 (66.55)	0.81 (20.57)	1.19 (30.23)	1.12 (28.45)	1.88 (47.75)		1.50 (38.10)	
40CL9900	F562C40	9/16 (14.29)	40,000 (2757.86)	0.250 (6.35)	1.88 (47.775)	2.62 (66.55)	0.81 (20.57)	1.19 (30.23)	1.12 (28.45)	1.88 (47.75)		1.50 (38.10)	
43CL16	F1000C43	1 (25.40)	43,000 (2964.70)	0.438 (11.13)	3.00 (76.20)	4.12 (104.65)	0.72 (18.29)	1.38 (35.05)	2.06 (52.32)	2.06 (52.32)		1.75 (44.45)	

Tee

CT4440	F250C	1/4 (6.35)	60,000 (4136.79)	0.094 (2.39)	1.25 (31.75)	2.00 (50.80)	0.50 (12.70)	0.63 (15.88)	0.88 (22.35)	1.00 (25.40)		1.00 (25.40)	See Figure 2
100CT4440	F312C150	1/4 (6.35)	100,000 (6894.65)	0.094 (2.39)	2.12 (53.85)	3.00 (76.20)	0.52 (13.21)	0.75 (19.05)	1.50 (38.10)	1.50 (38.10)		1.38 (35.05)	
CT5550	F312C150	5/16 (7.94)	150,000 (10341.97)	0.094 (2.39)	2.12 (53.85)	3.00 (76.20)	0.52 (13.21)	0.75 (19.05)	1.50 (38.10)	1.50 (38.10)		1.38 (35.05)	
CT6660	F375C	3/8 (9.53)	60,000 (4136.79)	0.125 (3.18)	1.56 (39.62)	2.00 (50.80)	0.52 (13.21)	0.81 (20.62)	1.06 (26.92)	1.00 (25.40)		1.00 (25.40)	
100CT6660	F312C150	3/8 (9.53)	100,000 (6894.65)	0.094 (2.39)	2.12 (53.85)	3.00 (76.20)	0.52 (13.21)	0.75 (19.05)	1.50 (38.10)	1.50 (38.10)		1.38 (35.05)	
CT9990	F562C	9/16 (14.29)	60,000 (4136.79)	0.188 (4.78)	2.12 (53.85)	2.62 (66.55)	0.81 (20.57)	1.19 (30.23)	1.38 (35.05)	1.31 (33.27)		1.50 (38.10)	
40CT9990	F562C40	9/16 (14.29)	40,000 (2757.86)	0.250 (6.35)	2.12 (53.85)	2.62 (66.55)	0.81 (20.57)	1.19 (30.23)	1.38 (35.05)	1.31 (33.27)		1.50 (38.10)	
43CT16	F1000C43	1 (25.40)	43,000 (2964.70)	0.438 (11.13)	3.00 (76.20)	4.12 (104.65)	0.72 (18.29)	1.38 (35.05)	2.06 (52.32)	2.06 (52.32)		1.75 (44.45)	

Cross

CX4444	F250C	1/4 (6.35)	60,000 (4136.79)	0.094 (2.39)	1.25 (31.75)	2.00 (50.80)	0.50 (12.70)	0.63 (15.88)	0.62 (15.75)	1.00 (25.40)		1.00 (25.40)	See Figure 3
100CX4444	F312C150	1/4 (6.35)	100,000 (6894.65)	0.094 (2.39)	3.00 (76.20)	3.00 (76.20)	0.52 (13.21)	0.75 (19.05)	1.50 (38.10)	1.50 (38.10)		1.38 (35.05)	
CX5555	F312C150	5/16 (7.94)	150,000 (10341.97)	0.094 (2.39)	3.00 (76.20)	3.00 (76.20)	0.52 (13.21)	0.75 (19.05)	1.50 (38.10)	1.50 (38.10)		1.38 (35.05)	
CX6666	F375C	3/8 (9.53)	60,000 (4136.79)	0.125 (3.18)	2.12 (53.85)	2.00 (50.80)	0.52 (13.21)	0.81 (20.62)	1.06 (26.92)	1.00 (25.40)		1.00 (25.40)	
100CX6666	F312C150	3/8 (9.53)	100,000 (6894.65)	0.094 (2.39)	2.12 (76.20)	3.00 (76.20)	0.52 (13.21)	0.75 (19.05)	1.50 (38.10)	1.50 (38.10)		1.38 (35.05)	
CX9999	F562C	9/16 (14.29)	60,000 (4136.79)	0.188 (4.78)	2.75 (69.85)	2.62 (66.55)	0.81 (20.57)	1.19 (30.23)	1.38 (35.05)	1.31 (33.27)		1.50 (38.10)	
40CX9999	F562C40	9/16 (14.29)	40,000 (2757.86)	0.250 (6.35)	2.75 (69.85)	2.62 (66.55)	0.81 (20.57)	1.19 (30.23)	1.38 (35.05)	1.31 (33.27)		1.50 (38.10)	
43CX16	F1000C43	1 (25.40)	43,000 (2964.70)	0.438 (11.13)	4.12 (104.65)	4.12 (104.65)	0.72 (18.29)	1.38 (35.05)	2.06 (52.32)	2.06 (52.32)		1.75 (44.45)	

*Maximum pressure rating is based on the lowest rating of any component.
Actual working pressure may be determined by tubing pressure rating, if lower.

All dimensions for reference only and subject to change.
For prompt service, Autoclave stocks select products. Consult your local representative.

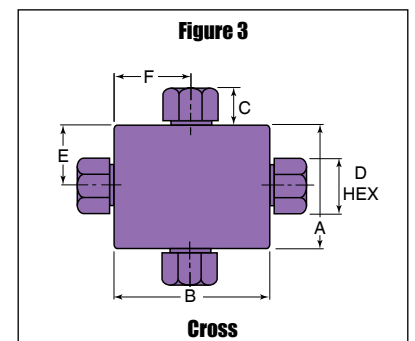
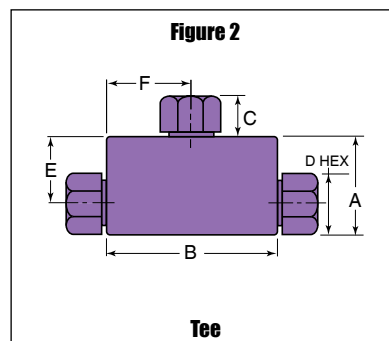
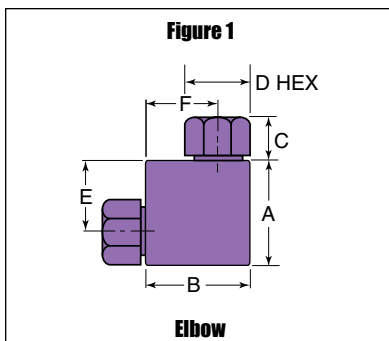

Note: Fittings such as 45° elbows, reducer elbows, and reducer 45° elbows are available upon request. For mounting hole option add suffix PM to catalog number, consult factory for mounting hole dimensions. Contact your local sales representative for additional information.

All general terms and conditions of sale, including limitations of our liability, apply to all products and services sold.

Catalog Number	Connection Type	Outside Diameter Tube	Pressure Rating psi (bar)*	Minimum Opening	Dimensions - inches (mm)							Block Thickness	Fitting Pattern
					A	B	C	D Typical	E	F Hex	G Thickness		

Straight Coupling/Union Coupling

60F4433	F250C	1/4	60,000	0.094	0.75	1.38	0.50	0.63	Straight			See Figure 4
60UF4433		(6.35)	(4136.79)	(2.39)	(19.05)	(35.05)	(12.70)	(15.88)	Union			
100F4433	F312C150	1/4	100,000	0.094	1.12	2.62	0.52	0.75	Straight			
100UF4433		(7.94)	(10341.97)	(2.39)	(28.45)	(66.55)	(13.21)	(19.05)	Union			
150F5533	F312C150	5/16	150,000	0.094	1.12	2.62	0.52	0.75	Straight			
150UF5533		(7.94)	(10341.97)	(2.39)	(28.45)	(66.55)	(13.21)	(19.05)	Union			
60F6633	F375C	3/8	60,000	0.125	1.00	1.75	0.53	0.81	Straight			
60UF6633		(9.53)	(4136.79)	(3.18)	(25.40)	(44.45)	(13.46)	(20.62)	Union			
100F6633	F312C150	3/8	100,000	0.094	1.12	2.62	0.52	0.75	Straight			
100UF6633		(9.53)	(6894.65)	(2.39)	(28.45)	(66.55)	(13.21)	(19.05)	Union			
60F9933	F562C	9/16	60,000	0.188	1.38	2.19	0.81	1.19	Straight			
60UF9933		(14.29)	(4136.79)	(4.78)	(35.05)	(55.63)	(20.57)	(30.15)	Union			
40F9933	F562C40	9/16	40,000	0.250	1.38	2.19	0.81	1.19	Straight			
40UF9933		(14.29)	(2757.86)	(6.35)	(35.05)	(55.63)	(20.57)	(30.15)	Union			
43F16	F1000C43	1	43,000	0.438	1.75	3.50	0.72	1.38	Straight			
43UF16		(25.40)	(2964.70)	(11.13)	(44.45)	(88.90)	(18.29)	(35.05)	Union			

Bulkhead Coupling

60BF4433	F250C	1/4	60,000	0.094	0.94	1.88	0.50	0.63	0.50	1.00	0.38	See Figure 5
100BF4433	F312C250	1/4	100,000	0.094	2.12	3.25	0.52	0.75	1.38	2.00	0.38	
150BF5533	F312C150	5/16	150,000	0.094	2.12	3.25	0.52	0.75	1.38	2.00	0.38	
60BF6633	F375C	3/8	60,000	0.125	1.12	2.38	0.53	0.81	0.78	1.38	0.38	
100BF6633	F312C150	3/8	100,000	0.094	2.12	3.25	0.52	0.75	1.38	2.00	0.38	
60BF9933	F562C	9/16	60,000	0.188	1.69	2.75	0.81	1.19	1.00	1.88	0.38	
40BF9933	F562C40	9/16	40,000	0.250	1.69	2.75	0.81	1.19	1.00	1.88	0.38	
43BF16	F1000C43	1	43,000	0.438	1.94	3.50	0.72	1.38	1.50	2.13	0.50	

*Maximum pressure rating is based on the lowest rating of any component.
Actual working pressure may be determined by tubing pressure rating, if lower.

All dimensions for reference only and subject to change.

For prompt service, Autoclave stocks select products. Consult your local representative.

Union Couplings are designed with a removable seat insert allowing disassembly and tubing removal without the necessity of loosening other items in a line.

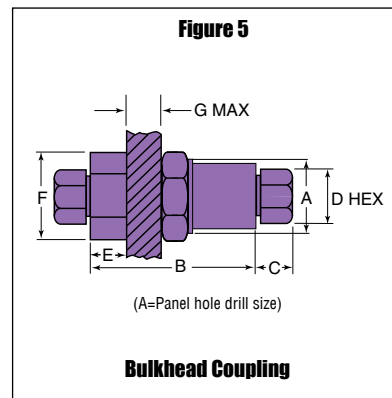
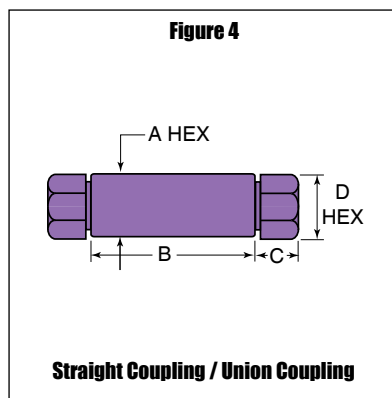

High Pressure Tubing

Pressures to 150,000 psi (10342 bar)

Autoclave Engineers offers a complete selection of austenetic, cold drawn stainless steel tubing designed to match the performance standards of Autoclave valves and fittings. Autoclave high pressure tubing is manufactured specifically for high pressure applications requiring both strength and corrosion resistance. The tubing is furnished in random lengths between 20 feet (6 meters) and 27 feet (8.2 meters). The average is 24 feet (7.3 meters). High pressure tubing is available in five sizes and a variety of materials. Special longer lengths are available. Consult factory.



Inspection and Testing

Autoclave Engineer's high pressure tubing is inspected to assure freedom from seams, laps, fissures or other flaws, as well as carburization or intergranular carbide precipitation. The outside and inside diameters of the tubing are controlled within close tolerances. Sample pieces of tubing for each lot are tested to confirm mechanical properties. Hydrostatic testing is also performed on a statistical basis and is conducted at the working pressure of the tube. Autoclave will perform 100% hydrostatic testing at additional cost if desired.

Special Materials

In addition to the type 316 and 304 stainless steel tubing listed in this section, Autoclave has limited stock of hard-to-obtain shorter lengths of the following tubing materials in some sizes:

*Monel 400**, *Inconel 600**, *Titanium Grade 2**, *Nickel 200**, *Hastelloy C276** - (* Trademark names)

Please consult factory for stock availability.

Tubing Tolerance

Nominal Tubing Size
inches (mm)

Tolerance/Outside Diameter
inches (mm)

1/4 (6.35)	.248/.243 (6.30/6.17)
5/16 (7.94)	.310/.306 (7.87/7.77)
3/8 (9.53)	.370/.365 (9.40/9.27)
9/16 (14.29)	.557/.552 (14.15/14.02)
1 (25.40)	.995/.990 (25.27/25.14)

Catalog Number	Tube Material	Fits Connection Type	Tube Size Inches (mm)			Flow Area in. ² (mm ²)	Working Pressure psi (bar)*				
			Outside Diameter	Inside Diameter	Wall Thickness		-325 to 100°F -198 to 37.8°C	200°F 93°C	400°F 204°C	600°F 316°C	800°F 427°C
MS15-202	Stainless ...	(See note 3)	1/4 (6.35)	0.083 (2.11)	0.083 (2.11)	0005 (3.23)	100,000 (6894.64)	100,000 (6894.64)	96,210 (6633.24)	90,368 (6230.55)	84,420 (5820.46)
MS15-081	316SS	F250C					60,000 (4136.79)	60,000 (4136.79)	57,750 (3981.66)	54,250 (3740.35)	50,700 (3495.59)
MS15-182	304SS						60,000 (4136.79)	56,800 (3916.16)	51,650 (3561.09)	50,700 (3495.59)	48,450 (3340.46)
MS15-082	316SS	F312C150	5/16 (7.94)	0.062 (1.57)	0.125 (3.18)	0.033 (1.94)	150,000 (10341.97)	150,000 (10341.97)	144,400 (9955.87)	136,350 (9400.85)	126,750 (8738.97)
MS15-201	Stainless.....	(See note 3)	3/8 (9.53)	0.125 (3.18)	0.125 (3.18)	0.012 (7.74)	100,000 (6894.64)	100,000 (6894.64)	96,210 (6633.24)	90,368 (6230.55)	84,420 (5820.46)
MS15-087	316SS	F375C					60,000 (4136.79)	60,000 (4136.79)	57,750 (3981.66)	54,250 (3740.35)	50,700 (3495.59)
MS15-183	304SS						60,000 (4136.79)	56,800 (3916.16)	51,650 (3561.09)	50,700 (3495.59)	48,450 (3340.46)
MS15-210	Stainless	F562C	9/16 (14.29)	0.188 (4.78)	0.187 (4.75)	0.028 (18.06)	100,000 (6894.64)	100,000 (6894.64)	96,210 (6633.24)	90,368 (6230.55)	84,420 (5820.46)
MS15-083	316SS						60,000 (4136.79)	60,000 (4136.79)	57,750 (3981.66)	54,250 (3740.35)	50,700 (3495.59)
MS15-185	304SS						60,000 (4136.79)	56,800 (3916.16)	51,650 (3561.09)	50,700 (3495.59)	48,450 (3340.46)
MS15-090	316SS	F562C40	9/16 (14.29)	0.250 (6.35)	0.156 (3.96)	0.048 (30.97)	40,000 (2757.86)	40,000 (2757.86)	38,500 (2654.44)	36,100 (2488.96)	33,800 (2330.39)
MS15-209	Stainless	F562C40-312	9/16 (14.29)	0.312 (7.92)	0.125 (3.18)	0.076 (49.03)	40,000 (2757.86)	40,000 (2757.86)	38,500 (2654.44)	36,100 (2488.97)	33,800 (2330.39)
MS15-211	316SS	F1000C43	1 (25.40)	0.438 (11.13)	0.281 (7.14)	0.151 (97.42)	43,000 (2964.70)	43,000 (2964.70)	43,000 (2964.70)	41,380 (2853.01)	36,330 (2504.83)
MS15-199	304SS	F1000C43	1 (25.40)	0.438 (11.13)	0.281 (7.14)	0.151 (97.42)	43,000 (2964.70)	40,600 (2799.23)	36,900 (2544.13)	36,300 (2502.76)	34,700 (2392.44)

Note:

- Autofretted tubing available (see technical information section: Pressure Cycling for Autofretting information)
- For High Pressure, High Cycle (HPHC) tubing, MS15-201, MS15-202, MS15-209, and MS15-210 are available. (See Technical Information section: Pressure Cycling for additional information)
- For 100,000 psi rating use F312C150 connection

*Maximum pressure rating is based on the lowest rating of any component.

Actual working pressure may be determined by tubing pressure rating, if lower.

All dimensions for reference only and subject to change.

For prompt service, Autoclave stocks select products. Consult your local representative.

High Pressure Coned-and-Threaded Nipples

Pressures to 150,000 psi (10342 bar)

For rapid system make-up, Autoclave Engineers supplies pre-cut, coned-and-threaded nipples in various sizes and lengths for Autoclave high pressure valves and fittings.

Special lengths

In addition to the standard lengths listed in the table below, nipples are available in any custom length. Consult factory.

Materials**

Catalog numbers in table refer to Type 316 Stainless steel.

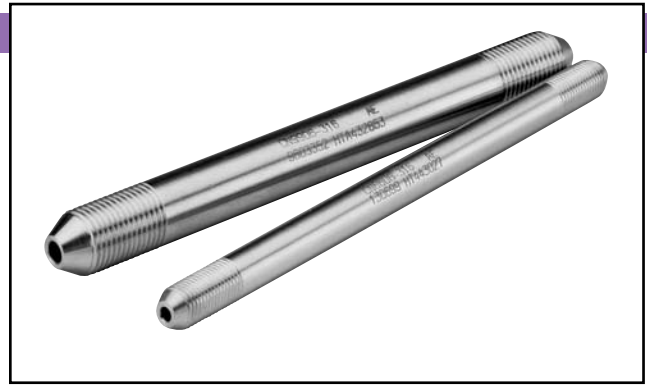

Material in table is 316 Stainless steel

Catalog Number							Fits Connection Type	Tube Size inches (mm)		Working* Pressure at 100°F (37.8°C) psi (bar)
Nipple Length In (mm)								O.D.	I.D.	
2.75" (69.85)	3.00" (76.20)	4.00" (101.60)	6.00" (152.40)	8.00" (203.20)	10.00" (254.00)	12.00" (304.80)				
CN4402-316	CN4403-316	CN4404-316	CN4406-316	CN4408-316	CN44010-316	CN44012-316	F250C	1/4 (6.35)	0.083 (2.11)	60,000 (4136.79)
	CN6603-316	CN6604-316	CN6606-316	CN6608-316	CN66010-316	CN66012-316	F375C	3/8 (9.53)	0.125 (3.18)	60,000 (4136.79)
		CN9904-316	CN9906-316	CN9908-316	CN99010-316	CN99012-316	F562C	9/16 (14.29)	0.188 (4.78)	60,000 (4136.79)
		CN5504-316	CN5506-316	CN5508-316	CN55010-316	CN55012-316	F312C150	5/16 (7.94)	0.062 (1.57)	150,000 (10341.97)
Material in table is 304 Stainless steel										
		40CN9904-304	40CN9906-304	40CN9908-304	40CN99010-304	40CN99012-304	F562C40	9/16 (14.29)	0.250 (6.35)	40,000 (2757.86)
			43CN1606-304	43CN1608-304	43CN16010-304	43CN16012-304	F1000C43	1 (25.40)	0.438 (12.40)	43,000 (2964.70)

Note:

See High pressure tubing section for pressure ratings at various temperatures.

**Type 304 stainless steel nipples available.

*Maximum pressure rating is based on the lowest rating of any component. Actual working pressure may be determined by tubing pressure rating, if lower.

All dimensions for reference only and subject to change.

For prompt service, Autoclave stocks select products. Consult your local representative.

High Pressure Check Valves

Pressures to 60,000 psi (4137 bar)

O-Ring Check Valves

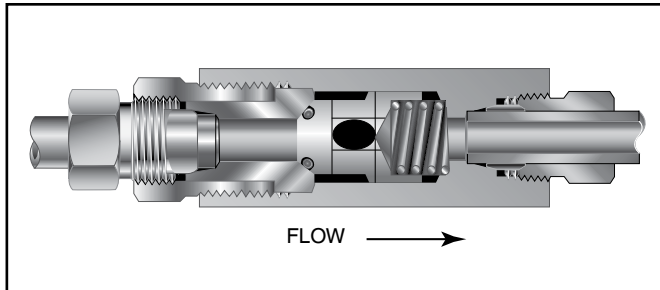

Minimum operating temperature for standard o-ring check valves 0°F (17.8°C).
For low temperature option to -423°F (-252°C) add suffix LTTO (Low temperature spring & Teflon o-ring).

Provides unidirectional flow and tight shut-off for liquids and gas with high reliability. When differential drops below cracking pressure*, valve shuts off. **(Not for use as relief valve.)**

Materials: 316 Stainless Steel: body, cover, poppet, cover gland. 300 Series Stainless Steel: spring. Standard O-ring: Viton, for operation to 400° F (204°C). Buna-N or Teflon available for 250°F (121°C) or 400°F (204°C) respectively; specify when ordering.

***Cracking Pressure:** 20 psi (1.38 bar) ±30%. Springs for higher cracking pressures (up to 100 psi (6.89 bar) available on special order for O-ring style check valves only.

Ball Check Valves

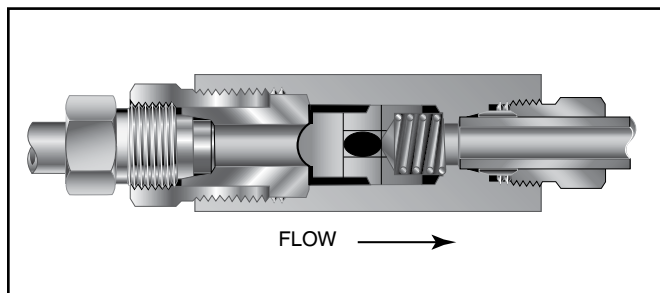

Minimum operating temperature for standard ball check valves -110° (-79°C).
For low temperature option to -423°F (-252°C) add suffix LT (Low temperature spring).

Prevents reverse flow where **leak-tight shut-off is not mandatory**. When differential drops below cracking pressure, valve closes. With all-metal components, valve can be used up to 1200°F (649°C). See Technical Information section for connection temperature limitations. **(Not for use as a relief valve.)**

Ball and poppet are an integral design to assure positive, in-line seating without “chatter”. Poppet is designed essentially for axial flow with minimum pressure drop.

Materials: 316 Stainless Steel: body, cover, ball poppet, cover gland. 300 Series Stainless Steel: spring.

Ball Type Excess Flow Valves

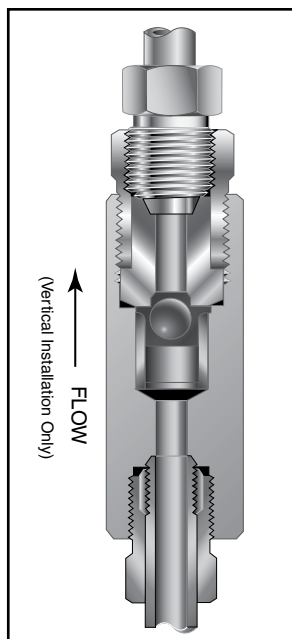

Protects pressure gauges and pressure instrumentation from surges in flow or sudden venting in the event of line failure.

Materials: 316 Stainless Steel: body, cover, sleeve, cover gland. 300 Series Stainless Steel: ball.

Vertical Installation: Since this type of check valve employs a non-spring loaded ball, valve **MUST** be installed in VERTICAL position with arrow on valve body pointing UP. (cover gland up).

Resetting Valve: Equalize the pressure across the ball. The ball will drop and reset automatically.

CAUTION: While testing has shown O-Rings to provide satisfactory service life, both cyclic and shelf life may vary widely with differing service conditions, properties of reactants, pressure and temperature cycling and age of the O-ring. **FREQUENT INSPECTIONS SHOULD BE MADE** to detect any deterioration, and O-rings replaced as required.

NOTE: For optional material see Needle Valve Options section.

High Pressure Check Valves

Catalog Number	Fits Connection Type	Pressure Rating psi (bar)*	Orifice inches (mm)	Rated C _v	Dimensions - inches (mm)					Fitting Pattern
					A	B	C	D Typical	Hex	

O-Ring Check Valves

CKO4400	F250C	60,000 (4136.79)	0.094 (2.39)	0.15	3.38 (85.85)	2.50 (63.50)	0.50 (12.70)	0.63 (16.00)	1.18 (29.97)	See Figure 1
CKO6600	F375C	60,000 (4136.79)	0.125 (3.18)	0.28	3.75 (95.25)	2.62 (66.55)	0.53 (13.46)	0.75 (19.05)	1.18 (29.97)	
CKO9900	F562C	60,000 (4136.79)	0.187 (4.75)	0.63	4.62 (117.35)	3.38 (85.85)	0.81 (20.57)	1.12 (28.45)	1.50 (38.10)	
40CKO9900	F562C40	40,000 (2757.85)	0.250 (6.35)	0.78	4.64 (117.86)	3.38 (85.73)	0.72 (18.29)	1.19 (30.23)	1.50 (38.10)	
43CKO16	F1000C43	43,000 (2964.70)	0.438 (11.13)	4.3	6.54 (166.11)	5.63 (143.00)	.72 (18.29)	1.38 (35.05)	1.88 (47.76)	

Ball Check Valves

CB4401	F250C	60,000 (4136.79)	0.094 (2.39)	0.15	3.38 (85.85)	2.50 (63.50)	0.50 (12.70)	0.63 (16.00)	1.18 (29.97)	See Figure 1
CB6601	F375C	60,000 (4136.79)	0.125 (3.18)	0.28	3.75 (95.25)	2.62 (66.55)	0.53 (13.46)	0.75 (19.05)	1.18 (29.97)	
CB9901	F562C	60,000 (4136.79)	0.187 (4.75)	0.63	4.62 (117.35)	3.38 (85.85)	0.81 (20.57)	1.12 (28.45)	1.50 (38.10)	
43CB16	F1000C43	43,000 (2964.70)	0.438 (11.13)	4.3	6.54 (166.11)	5.63 (143.00)	.72 (18.29)	1.38 (35.05)	1.88 (47.76)	

Ball Type Excess Flow Valves

CK4402	F250C	60,000 (4136.79)	0.094 (2.39)		3.38 (85.85)	2.50 (63.50)	0.50 (12.70)	0.63 (16.00)	1.18 (29.97)	See Figure 1
CK6602	F375C	60,000 (4136.79)	0.125 (3.18)		3.75 (95.25)	2.62 (66.55)	0.53 (13.46)	0.75 (19.05)	1.18 (29.97)	
CK9902	F562C	60,000 (4136.79)	0.187 (4.75)		4.62 (117.35)	3.38 (85.85)	0.81 (20.57)	1.12 (28.45)	1.50 (38.10)	

*Maximum pressure rating is based on the lowest rating of any component.
Actual working pressure may be determined by tubing pressure rating, if lower.

All dimensions for reference only and subject to change.

For prompt service, Autoclave stocks select products. Consult your local representative.

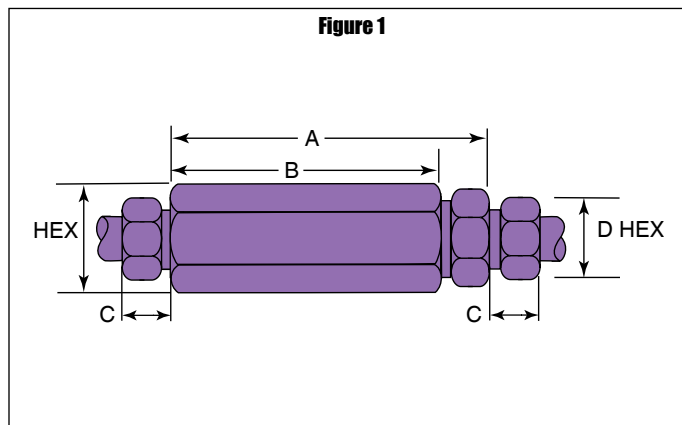

High Pressure Line Filters

Pressures to 60,000 psi (4137 bar)

Dual-Disc Line Filters

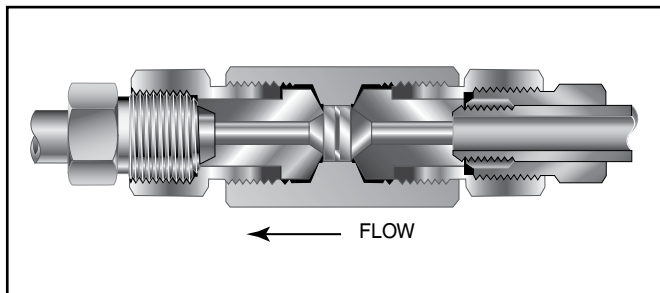

Autoclave Engineers Dual-Disc Line Filters are utilized in numerous industrial, chemical processing, aerospace, nuclear and other applications. With the dual-disc design, large contaminant particles are trapped by the upstream filter element before they can reach and clog the smaller micron-size downstream element. Filter elements can be easily replaced.

Materials: 316 Stainless Steel: body, cover, cover gland.
300 Series Stainless Steel: filter elements.

Filter Elements: Downstream/upstream micron size 35/65 is standard. 5/10 or 10/35 also available when specified. Other element combinations available on special order.

Cup-Type Line Filters

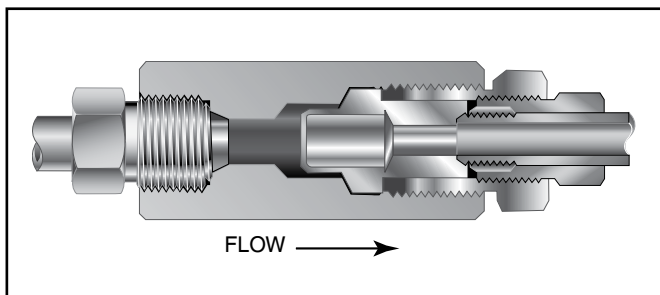

Autoclave Engineers High Flow Cup-Type Line Filters are recommended in high pressure systems requiring both high flow rates and maximum filter surface area. Widely used in the industrial and chemical processing fields, the cup design offers as much as six times the effective filter area as compared to disc-type units. In addition, the filter elements can be quickly and easily replaced.

Materials: 316 Stainless Steel: body, cover, cover gland.
300 Series Stainless Steel: filter element.

Filter Elements: 300 Series Stainless Steel sintered cup. Standard elements available in choice of 5, 35 or 65 micron sizes. **NOTE:** Filter ratings are nominal.

NOTE 1: All filters furnished complete with connection components unless specified without. All dimensions for reference only and subject to change.

NOTE 2: Autoclave Engineers disc and cup type filters are designed to filter small amounts of process particles. It is recommended that all fluids are thoroughly cleaned prior to entering the higher pressure system.

For optional materials, see Needle Valve Options section

NOTE 3: Special material filters may be supplied with four flats in place of standard hex.

NOTE 4: Pressure differential not to exceed 1,000 psi (69 bar) in a flowing condition.

Catalog Number	Pressure Rating psi (bar)*	Orifice inches (mm)	Micron Size**	Connection Size and Type	Effective Filter Element Area in. ² (mm ²)	Dimensions - inches (mm)				
						A	B	C	D Typical	Hex

Dual-Disc Line Filters

CLF4400	60,000	0.094	35/65	F250C	0.07 (45.16)	4.75 (20.65)	3.00 (76.20)	0.50 (12.70)	.63 (16.00)	1.12 (28.45)
CLF4400-5/10	(4136.79)	(2.39)	5/10							
CLF4400-10/35			10/35							
CLF6600	60,000	0.125	35/65	F375C	0.07 (45.16)	5.12 (130.16)	3.00 (76.20)	0.53 (13.46)	.75 (19.05)	1.12 (28.45)
CLF6600-5/10	(4136.79)	(3.18)	5/10							
CLF6600-10/35			10/35							
CLF9900	60,000	0.187	35/65	F562C	0.15 (96.77)	5.81 (147.57)	3.38 (85.85)	0.81 (20.58)	1.12 (28.45)	1.38 (35.05)
CLF9900-5/10	(4136.79)	(4.75)	5/10							
CLF9900-10/35			10/35							

Cup-Type Line Filters

CF4-5	60,000	0.094	5	F250C	1.29 (832.26)	4.19 (106.42)	3.38 (85.85)	0.50 (12.70)	.63 (16.00)	1.38 (35.05)
CF4-35	(4136.79)	(2.39)	35							
CF4-65			65							
CF6-5	60,000	0.125	5	F375C	1.29 (832.26)	4.62 (117.35)	3.62 (91.94)	0.53 (13.46)	.75 (19.05)	1.38 (35.05)
CF6-35	(4136.79)	(3.18)	35							
CF6-65			65							
CF9-5	60,000	0.187	5	F562C	1.29 (832.26)	5.25 (133.35)	4.06 (103.12)	0.81 (20.58)	1.12 (28.45)	1.50 (38.10)
CF9-35	(4136.79)	(4.75)	35							
CF9-65			65							

Note:

** Other micron sizes available on special order. Change last digits of the catalog number accordingly.

For optional materials, see Needle Valve Options section.

*Maximum pressure rating is based on the lowest rating of any component.
Actual working pressure may be determined by tubing pressure rating, if lower.

All dimensions for reference only and subject to change.

For prompt service, Autoclave stocks select products. Consult your local representative.

Dual-Disc Line Filters

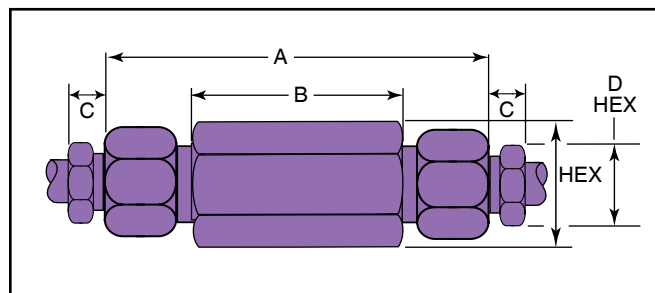

Cup-Type Line Filters

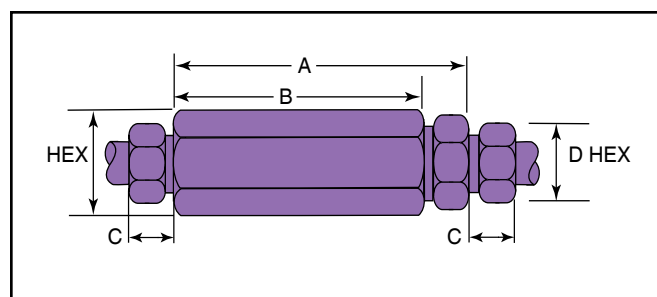

High Anti-Vibration Collet Gland Assembly

Pressures to 150,000 psi (10342 bar)

Series KCGL Sizes to 9/16" (14.29 mm)

For extreme conditions of vibration and/or shock in tubing systems, such as locating valve or fitting on an unsupported line near a compressor, Autoclave coned-and-threaded connections are offered with the Anti-Vibration Collet Gland Assemblies. Completely interchangeable with standard Autoclave high pressure connections, the Collet Gland Assemblies provide equally effective pressure handling capability.

In standard connection systems, the bending stresses on the threaded area of the tubing imposed by excessive vibration or movement may cause premature fatigue failure of the tubing at the back of the thread. By moving the stress concentration back to the unthreaded part of the tubing and providing a wedge-type gripping action, the Autoclave Engineers anti-vibration collet gland assembly strengthens the entire structure. With stress concentration reduced and overall stress level maintained well below the endurance limit of the material, the result is virtually unlimited vibrational fatigue life.

A less complex and more economical design than other vibration-resistant connections, the Collet Gland Assembly utilizes the same coned-and-threaded features of Autoclave high pressure connections. In Series KCGL the gland nut is recessed to accommodate a tapered, slotted collet that grips the tubing at a point behind the threaded area of the tubing. The design provides a slight difference in angles between the collet and the corresponding taper of the gland nut. As the nut is tightened, it acts to wedge the tapered end of the collet into a gripping engagement with the tubing and, at the same time, forces the collar and tubing assembly into line contact with the connection seat.

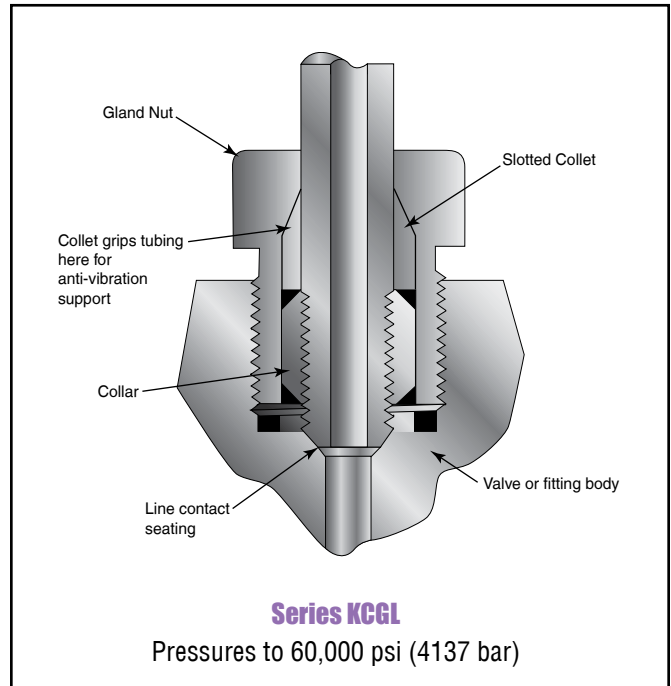

- Note: 1) To order components with anti-vibration assemblies add -K to catalog numbers.
 2) Special material assemblies may be supplied with four flats in place of standard hex.

Catalog Number	Part	Outside Diameter Tubing Size in. (mm)	Dimensions - inches (mm)		
			A	B	Hex
KCGL40-316	Complete assembly	1/4 (6.35)	0.50 (12.70)	0.81 (20.58)	0.62 (15.75)
KCL40-316	Slotted collet				
KGL40-316	Gland nut				
KCGL60-316	Complete assembly	3/8 (9.53)	0.62 (15.75)	1.12 (28.45)	0.81 (20.58)
KCL60-316	Slotted collet				
KGL60-316	Gland nut				
KCGL90-316	Complete assembly	9/16 (14.29)	1.00 (25.40)	1.50 (38.10)	1.19 (30.23)
KCL90-316	Slotted collet				
KGL90-316	Gland nut				

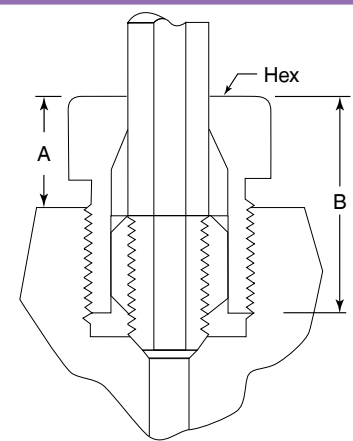

Series KCGL
60,000 psi (4137 bar)

Standard Autoclave Engineers collar not included in complete assembly

All dimensions for reference only and subject to change.

For prompt service, Autoclave stocks select products. Consult your local representative.

All general terms and conditions of sale, including limitations of our liability, apply to all products and services sold.

Series KCBGLX - Sizes to 1" (25.40)

Series KCBGL - Sizes to 1/4" (6.35), 5/16" (7.94), 3/8" (9.53)

For extreme conditions of vibration and/or shock in tubing systems, such as locating a valve or fitting on an unsupported line near a compressor, Autoclave coned-and-threaded connections are offered with the Anti-Vibration Collet Gland Assemblies. A less complex and more economical design than other vibration-resistant connections, the collet gland assembly utilizes the same coned-and-threaded features of Autoclave high pressure connections.

Series KCBGLX and KCBGL extends the gland nut to provide room for the tapered, slotted collet and collet nut. The design provides a slight difference in angles between the collet and the corresponding taper of the gland nut. As the nut is tightened, it acts to wedge the tapered end of the collet into a gripping engagement with the tubing.

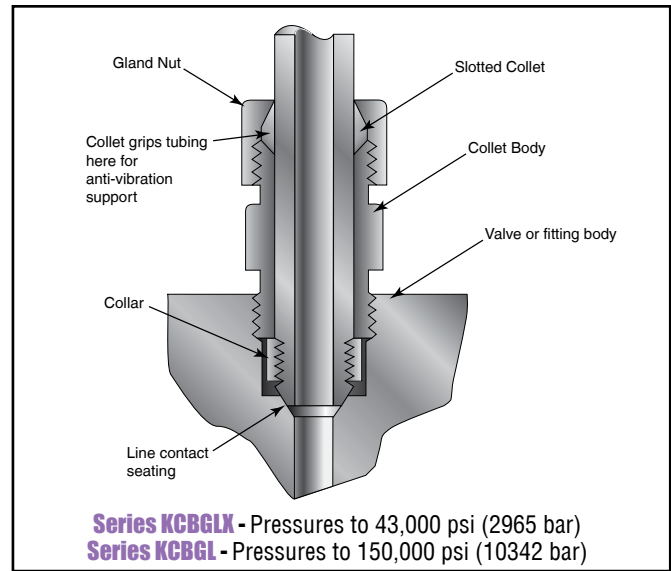

- Note: 1) To order components with anti-vibration assemblies add -K to catalog numbers.
 2) Special material assemblies may be supplied with four flats in place of standard hex.

Catalog Number	Part	Outside Diameter Tubing Size in. (mm)	Dimensions - inches (mm)		
			A	B	Hex
KCBGLX160-316MC	Complete assembly	1.0 (25.40)	1.69 (42.92)	2.38 (60.45)	1.50 (38.10)
KCBLX160-316MC	Collet body				
KCCLX160-316MC	Slotted collet				
KGLX160-316MC	Gland nut				
KCBGL40-316MC	Complete assembly	.250 (6.35)	1.38 (34.92)	1.88 (47.62)	.75 (19.05)
KCBL40-316MC	Collet body				
KCCL40-316MC	Slotted collet				
KGL40-316MC	Gland nut				
KCBGL50-316MC	Complete assembly	.312 (7.94)	1.38 (34.92)	1.88 (47.62)	.75 (19.05)
KCBL50-316MC	Collet body				
KCCL50-316MC	Slotted collet				
KGL50-316MC	Gland nut				
KCBGL60-316MC	Complete assembly	.375 (9.53)	1.38 (34.92)	1.88 (47.62)	.75 (19.05)
KCBL60-316MC	Collet body				
KCCL60-316MC	Slotted collet				
KGL60-316MC	Gland nut				

Series KCBGLX - 43,000 psi (2965 bar)
Series KCBGL - 150,000 psi (10342 bar)

Standard Autoclave Engineers collar not included in complete assembly

All dimensions for reference only and subject to change.

For prompt service, Autoclave stocks select products. Consult your local representative.

All general terms and conditions of sale, including limitations of our liability, apply to all products and services sold.

! WARNING !

FAILURE OR IMPROPER SELECTION OR IMPROPER USE OF THE PRODUCTS AND/OR SYSTEMS DESCRIBED HEREIN OR RELATED ITEMS CAN CAUSE DEATH, PERSONAL INJURY AND/OR PROPERTY DAMAGE.

This document and other information from Snap-tite, Inc., its subsidiaries and authorized distributors, provides product and/or system options for further investigation by users having technical expertise. It is important that you analyze all aspects of your application and review the information concerning the product or system in the current product catalog. Due to the variety of operation conditions and applications for these products or systems, the user, through its own analysis and testing, is solely responsible for making the final selection of the products and systems and assuring that all performance, safety and warning requirements of the application are met.

The products described herein, including without limitation, product features, specifications, designs, availability and pricing, are subject to change by Snap-tite, Inc. and its subsidiaries at any time without notice.



Industrial Estate
 Whitemill-Wexford
 Republic of Ireland
 PH: 353 53 914 1566 FAX: 353 53 914 1582
 e-mail: ste_sales@snap-tite.com
www.snap-tite.com



Fluid Components
 Division of Snap-tite, Inc.
 8325 Hessinger Drive
 Erie, Pennsylvania 16509-4679 USA
 PH: 814-860-5700 FAX: 814-860-5811
 e-mail: ae_sales@snap-tite.com
www.autoclave.com

ISO-9001 Certified

02-0125SE-0109