

PUMPS

FOR TORQUE WRENCHES, NUT SPLITTERS & SPREADERS

700 BAR (10,000 PSI) - HIGH PERFORMANCE HYDRAULIC PUMPS

Page
**BOLTING PUMP
SUMMARY
CHART...70**

	Torque or Split										Tension	
	PE39	PE45	PE55TWP-BS	PA60A	PA60A	PA60A	RWP55-BS	RWP55-BS	RWP55-BS	RWP55-BS	RWP55-BS	PE55TWP-BS
SPX	X	X	X	X	X	X	X	X	X	X	X	X
WYD	X	X	X	X	X	X	X	X	X	X	X	X
SP	X	X	X	X	X	X	X	X	X	X	X	X
SP	X	X	X	X	X	X	X	X	X	X	X	X
SP	X	X	X	X	X	X	X	X	X	X	X	X
SP	X	X	X	X	X	X	X	X	X	X	X	X

Page
X1E1-PT...80-81
Legacy Series Electric
Hydraulic Pump



Page
ISP ADVANTAGE...71

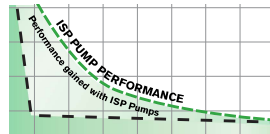

Page
PG120TWP...82-83
Gas Powered Pump



Page
PE45...72-73
Infinity Series Electric Pump



Page
RWP55-BS...84-85
Classic Series Air
Hydraulic Pump



Page
PA60A...74-75
Infinity Series Air Pump



Page
X1A1-PT...86-87
Legacy Series Air
Hydraulic Pump



Page
PE39...76-77
Compact Torque Wrench Pump



Page
P SERIES...88-89
Hand Pumps
700 bar (10,000 psi)



Page
PE55TWP-BS...78-79
Classic Series Electric
Hydraulic Pump



BOLTING PUMP SUMMARY CHART

Most customers choose to use hand pumps for spreading and nutsplitting applications because of their ability to spread and hold. When using spreaders with torque wrench pumps, use only the top port advance and know that the spreader will retract when the pump is turned off.

Bold Products have higher stocking levels. X

		Torque or Split								Tension			
		PE39	PE45	PE55TWP-BS	X1E#-PT	PG120TWP	PA60A	RWP55-BS	RWP55-Dual	X1A1-PT	PE8	HPUTP-1	HPUTP-2
POWER SOURCE	ELECTRIC (110/115V)	X	X	X	X						X		
	ELECTRIC (220/230V)	X	X	X	X						X		
	AIR					X	X	X	X			X	X
	GAS				X								
ELECTRIC MOTOR TYPE	UNIVERSAL	X	X	X	X	n/a					X		
	INDUCTION					n/a							
MAX PRESSURE	10,000 PSI (700 BAR)	X	X	X	X	X	X	X	X	X			
	21,750 PSI (1,500 BAR)										X	X	X
PUMP TYPE	TWO-STAGE	X		X	X	X	X	X	X	X			
	INFINITE STAGE (ISP)		X				X						
FLOW RATE @MAX PRESSURE	LOW (<20 IN ³ /MIN, <0.33 L/min)										X		
	MED. (<40 IN ³ /MIN, <0.66 L/min)	X											
	HIGH (<60 IN ³ /MIN, <0.98 L/min)		X	X	X		X	X		X		X	
	VERY HIGH (>60 IN ³ /MIN, >0.98 L/min)					X			X				X
SPEED @MAX PRESSURE	SLOW	X									X		
	MED			X	X			X		X		X	
	FAST		X			X	X		X				X
APPLICATION TYPE	ORIGINAL INSTALL		X	X	X	X	X	X	X	X	X	X	X
	OPERATIONS/MRO/SERVICE	X		X	X			X		X	X	X	X
DUTY CYCLE	CONTINUOUS		X	X	X	X	X	X	X	X	X	X	X
	INTERMITTENT	X		X	X			X		X	X	X	X
# OF PORTS (TOOL QUANTITY)	1	X	X	X	X	X	X	X	X	X			
	2										X	X	X
	4		X	X			X	X	X				
OIL TANK CAPACITY	0.5 GAL (1.9 L)	X											
	1.0 GAL (3.8 L)										X		
	1.25 GAL (4.7 L)												
	1.5 GAL (5.7 L)		X										
	2.0 GAL (7.6 L)						X						
	2.5 GAL (9.4 L)			X	X			X		X		X	X
	3.0 Gal (11.3 L)					X							
5.0 GAL (18.9 L)								X					
SPECIAL CONSIDERATIONS/ LOCATIONS/ APPLICALTIONS *	SUBSEA (UNDERWATER)												X
	WIND/UP-TOWER, TIGHT SPACE	X									X		
	WIND/FOUNDATION TENSION										X	X	X
	ATEX II 2 GdC T4						X						
	CE	X	X			X	X	X			X	X	X
	AUTO CYCLE		X										
	PENDANT INCLUDED	X	X	X	X	X	X	X	X	X	X		
OPTIONAL COOLER AVAILABLE	X	X					X						

Virtually any pump may be used for Original Installation or Service. This chart factors pump cost and usage together to determine a total cost of ownership and recommends a pump based upon value delivered.

* Please contact factory of authorized reseller with questions about special applications.

Pumps designed for torque wrench applications do not hold pressure, they should NOT be used for lifting applications and should be used with caution for spreading applications.

The Infinity Stage Pump (ISP) from SPX FLOW helps get work done faster. The innovative, patent pending design takes advantage of a continuously variable output that provides maximum flow within the rated pressure range of the pump - from 0 - 700 bar (0 to 10,000 psi). Most torquing and spreading work is done between 70 - 400 bar (1,000 - 6,000 psi), which is where the Infinity Stage Pumps (ISP) provide the most significant advantage over traditional pumps. For example, at 70 bar (1,000 psi) there is 5X as much flow as a traditional two-stage pump. At 275 bar (4,000 psi) there is 2X as much flow as a traditional pump.

THE ISP ADVANTAGE: INCREASED PRODUCTIVITY

The additional flow moves tools faster which allows work to be done quicker and more efficiently. The increased efficiency saves you time - allowing you to get onto your next job sooner and more profitably.

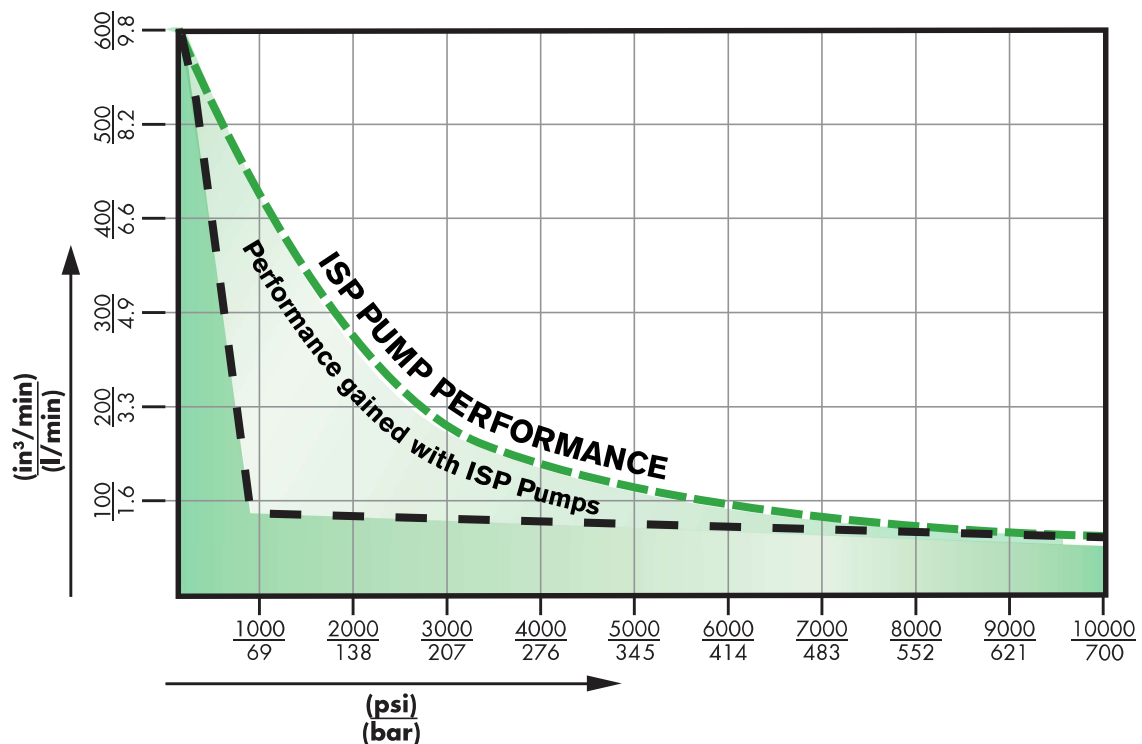

FEATURED ON

PE45



PA60A



INFINITY SERIES ELECTRIC PUMP

PE45
700 bar/10,000 psi



700 BAR (10,000 PSI) INFINITY SERIES (ISP) ELECTRIC PUMP

The PE45 is an Infinite Stage Electric Pump which increases productivity on the job by providing continuous pressure for up to 2x the speed of typical 2-stage pumps. Jobs get done faster and easier.

Quality means Lower Life-Cycle Costs:

- Over 100,000 cycles
- Continuous duty up to 50°C (122°F) ambient
- Proven design = Proven reliability

Enhanced Usability:

- Light Weight: 32.2 kg (71 lb) [without oil]
- Removable control pendant (5 m/15 ft)
- Removable 100mm (4"), calibration-capable gauge
- Universal Motor for reduced voltage applications (up to -20% nominal voltage)
- 4 tool manifold available powers up to 4 tools from a single pump (not for lifting applications)
- High flow to get work done faster

Designed with Safety in Mind:

- Easily adjusted pressure regulator (relief) valve
- Fixed 103 bar (1,500 psi) retract relief valve pressure

DESIGNED FOR

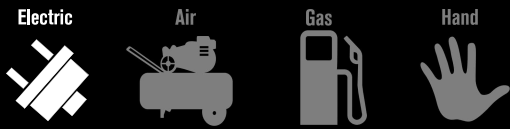

MAINTENANCE
& REPAIR

ORIGINAL
INSTALL

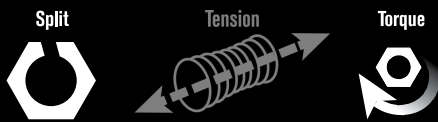

Max
Flow



Specifications and Dimensional Data

Size (L x W x H): 45 cm x 35.6 cm x 67.5 cm
17.7" x 14.0" x 26.6"

Weight: 32.2 kg (71 lb) [without oil]

Maximum Oil Capacity: (vented reservoir)
6.75 L (1.5 Gallons) [to fill line]
5.1 L (1.12 Gallons) [usable]

Operating Environment:
-25°C to +50°C (-13°F to +122°F)

(When operating near temperature extremes, it is recommended to use hydraulic oils that are rated for those temperatures. Refer to service manual and cooling option)

Sound Level: 87-92 dBA (max)

Pressure: 0 - 700 bar (0 - 10,000 psi)

Typical Flow: 9.4 L/min - 0.8 L/min
(575 in³/min - 48 in³/min)

Power: 1.8 hp Universal Motor
110/115V - 50/60 Hz (17 amps)
220/230V - 50/60 Hz (8.5 amps)

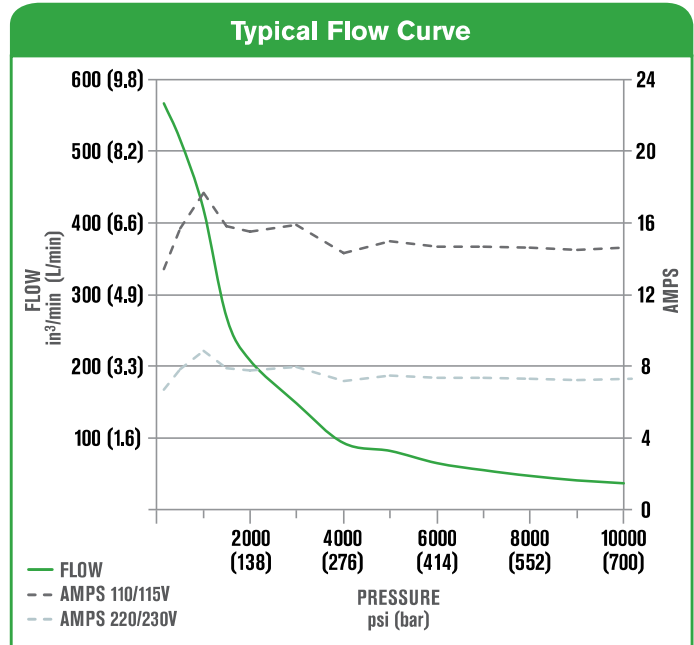

OPTIONS:

- Oil Cooling System
- Roll Cage
- 4-Port manifold
- 115V grounded plug pre-installed

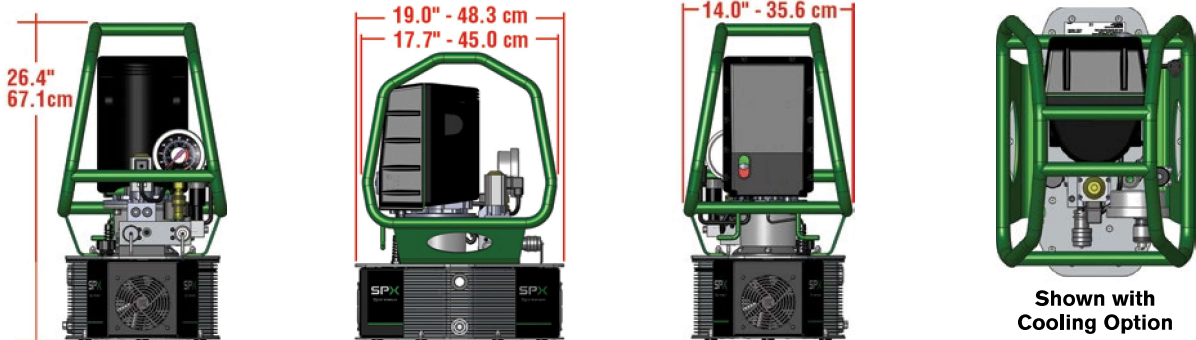

Ordering Information

PE 45 **EE 4** **PRS**

Power Source

- Y** = 110/115 VAC w/plug
- L** = 110/115 VAC w/flying leads (not stocked)
- P** = 220/230 VAC w/flying leads

Auto Cycle

- Blank** = No Auto Cycle
- A** = w/Auto Cycle

Cooling

- Blank** = w/o cooling
- C** = w/cooling

- Ports

- Blank** = 1 port (1 tool)
- M** = 4 ports (4 tools)

Example: PE45YEE4ACMPRS

PE45 Electric Pump with 110/115 VAC Motor with cord with typical grounded 3 prong plug, with Auto Cycle Feature, with active Cooling reservoir and with 4 ports.

INFINITY SERIES AIR PUMP

PA60A

700 bar/10,000 psi



700 BAR (10,000 PSI) INFINITY SERIES (ISP) AIR PUMP

The PA60A is an Infinity Stage Air Pump which increases productivity on the job by providing continuous pressure for up to 2x the speed of typical 2-stage pumps. Jobs get done faster and easier.

Quality means Lower Life-Cycle Costs:

- Over 100,000 cycles
- Continuous duty up to 50°C (122°F) ambient
- Proven design = Proven reliability

Enhanced Usability:

- Light weight and portable: 34.9 kg (77 lb) [without oil] PA60APF5FP
- Light weight and portable: 40.1 kg (88 lb) [without oil] PA60APF5FMPR
- Removable control pendant (7.6 m/ 25 ft)
- Removable 100 mm (4"), calibration-capable gauge
- **CE**
- ATEX **Ex** II 2 GDc T4
- 4 port manifold available to power up to 4 tools from a single pump (not for lifting applications)
- Fewer parts for lower service cost

Designed with Safety in Mind:

- Easily adjusted pressure regulator (relief) valve
- Fixed 103 bar (1,500 psi) retract relief valve pressure

DESIGNED FOR

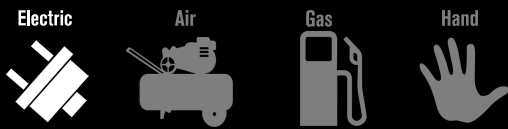

MAINTENANCE
& REPAIR

ORIGINAL
INSTALL



Max
Flow



Specifications and Dimensional Data

Size (L x W x H): 50 cm x 36 cm x 51 cm
19.6" x 14.0" x 20.2" (PA60APF5FMP)

Size (L x W x H): 47 cm x 30 cm x 53 cm
18.6" x 11.8" x 21.0" (PA60APF5FMPR)

Weight:

34.9 kg (76.9 lb) [without oil] PA60APF5FP
36.9 kg (81.5 lb) [without oil] PA60APF5FMP
37.9 kg (83.7 lb) [without oil] PA60APF5FPR
40.0 kg (88.3 lb) [without oil] PA60APF5FMPR

Maximum Oil Capacity: (vented reservoir)

8.5 L (2.2 Gallons) [to fill line]
7.0 L (1.8 Gallons) [usable]

Operating Environment:

-25°C to +50°C (-13°F to +122°F)

(When operating near temperature extremes, it is recommended to use hydraulic oils that are rated for those temperatures. Refer to service manuals and cooling options)

Sound Level: 76 dBA (max)

Pressure: 0 - 700 bar (0 - 10,000 psi)

Typical Flow: 9.4 L/min - 0.8 L/min
(575 in³/min - 48 in³/min)

Air: 2.3 m³/min @ 5.5 bar (80 cfm @ 80 psi)
2.5 m³/min @ 6.2 bar (90 cfm @ 90 psi)
2.8 m³/min @ 6.9 bar (100 cfm @ 100 psi)

* Values shown are with filter/regulator/lubricator.
Values will increase without filter/regulator/lubricator.

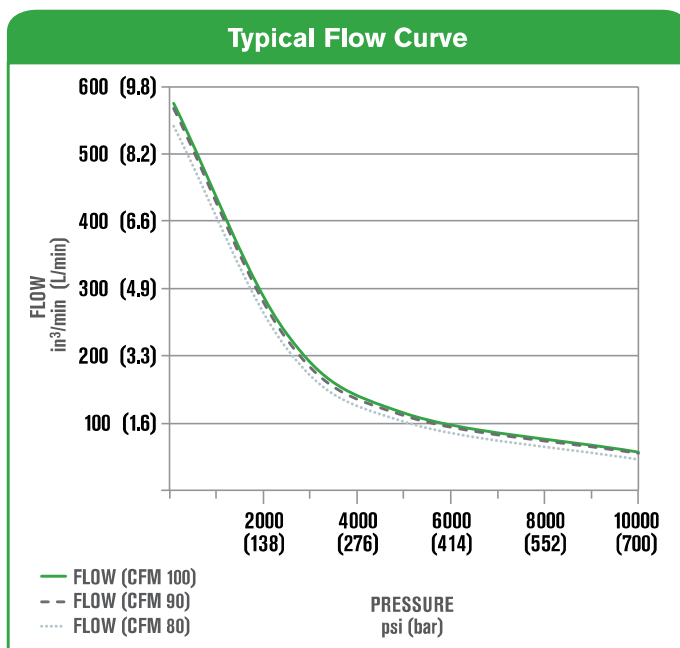

Hydraulic Oil Delivery

	@ 100 cfm	@ 90 cfm	@ 80 cfm
750 psi 51 bar	9.4 L/min (575 in ³ /min)	9.3 L/min (567 in ³ /min)	8.9 L/min (541 in ³ /min)
2,500 psi 175 bar	3.8 L/min (233 in ³ /min)	3.7 L/min (225 in ³ /min)	3.4 L/min (211 in ³ /min)
5,000 psi 350 bar	1.9 L/min (115 in ³ /min)	1.8 L/min (111 in ³ /min)	1.7 L/min (102 in ³ /min)
10,000 psi 700 bar	0.9 L/min (57 in ³ /min)	0.9 L/min (55 in ³ /min)	0.8 L/min (46 in ³ /min)

Ordering Information

Order No.	Description
PA60APF5FMP	PUMP, ISP 60 CU-IN/MIN, AIR/HYD, 4-PORT
PA60APF5FMPR	PUMP, ISP 60 CU-IN/MIN, AIR/HYD 4-PORT, Roll Cage
PA60APF5FP	PUMP, ISP 60 CU-IN/MIN, AIR/HYD
PA60APF5FPR	PUMP, ISP 60 CU-IN/MIN, AIR/HYD, Roll Cage

COMPACT ELECTRIC TORQUE WRENCH PUMP

PE39
700 bar/10,000 psi



700 BAR (10,000 PSI) COMPACT ELECTRIC TORQUE WRENCH PUMP

The PE39 is compact and capable of being used in a vertical or horizontal orientation. Based on proven pump design for reliability in rugged torque wrench applications to support operation and maintenance requirements.

Quality means Lower Life-Cycle Costs:

- Over 100,000 cycles
- Continuous duty up to 50°C (122°F) ambient
- Proven design = proven reliability

Enhanced Usability:

- Light weight and portable: 17.7 kg (39 lb)
- Removable control pendant (5 m/15 ft cord length)
- Removable 100 mm (4") calibration-capable gauge
- Universal Motor for reduced voltage applications (up to -20% nominal voltage)
- Vertical or horizontal operation
- Easy install cooling fan as option

Designed with Safety in Mind:

- Easily adjusted pressure regulator (relief) valve
- Fixed 103 bar (1,500 psi) retract relief valve pressure

DESIGNED FOR

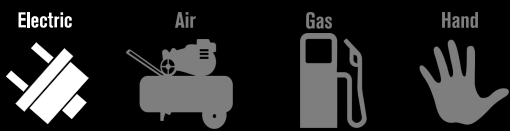

MAINTENANCE & REPAIR

ORIGINAL INSTALL



Max Flow



To be used with torque wrenches, pages 10-31

Specifications and Dimensional Data

Size (L x W x H): 35 cm x 27.4 cm x 60 cm
13.8" x 10.8" x 23.7"

Weight: 17.7 kg (39 lb) [without Oil]

Maximum Oil Capacity: (non-vented reservoir)
1.9 L (0.5 Gallons) [to fill line]
1.5 L (0.4 Gallons) [usable]

Operating Environment: -25°C to +50°C
(-13°F to +122°F)

(When operating near temperature extremes, it is recommended to use hydraulic oils that are rated for those temperatures. Refer to service manuals and cooling options)

Sound Level: 87 – 92 dBA (max)

Pressure: 0 - 700 bar (0 - 10,000 psi)

Typical Flow: 3.7 L/min - 0.64 L/min
(225 in³/min - 39 in³/min)

Power: 1.3 hp Universal Motor
110/115V - 50/60 Hz (14.5 amps)
220/230V - 50/60 Hz (7.2 amps)



Typical Flow Curve

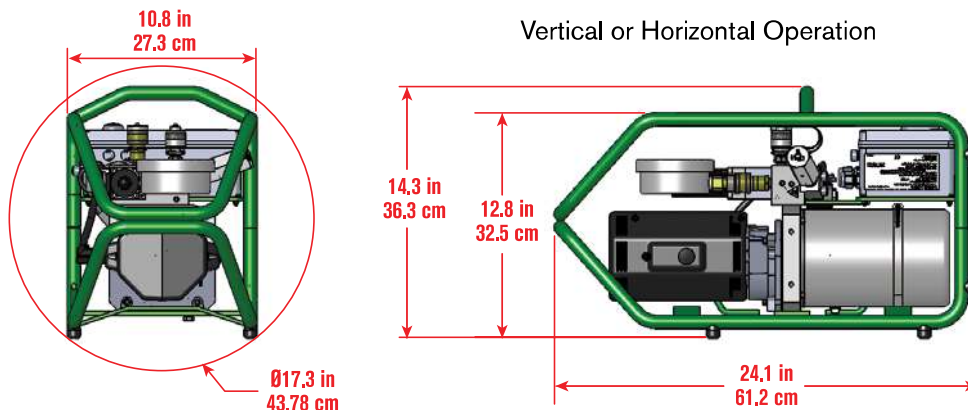
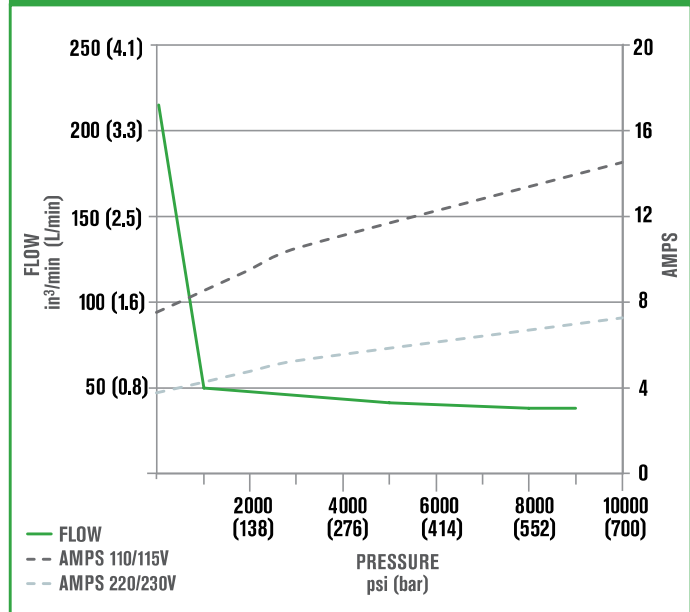

Ordering Information

Order No.	Description
PE39YED1PR	110/115VAC
PE39YED1BPR	110/115VAC with cooling option
PE39PED1PR	220/230VAC
PE39PED1BPR	220/230VAC with cooling option

OPTIONS

- Auxiliary Cooling Fan (Field Installable)
Order No. 3000610

CLASSIC SERIES ELECTRIC HYDRAULIC PUMP

PE55TWP-BS
700 bar/10,000 psi



700 BAR (10,000 PSI) CLASSIC SERIES ELECTRIC HYDRAULIC PUMP

The PE55TWP-BS has been the market leading electric pump for over 30 years & is therefore tried & tested. A simple, light-weight design with a recent upgrade that has created a cost-effective workhorse.

Quality means Lower Life-Cycle Costs:

- Over 100,000 cycles
- Continuous duty up to 50°C (122°F) ambient
- Proven design = Proven reliability

Enhanced Usability:

- Two Speed High Performance pump
- Retract side internal relief valve protects tool
- Hand remote
- Four-tool manifold (-4 models only) allow use of up to four tools simultaneously
- 4" calibration capable gauge
- Use with single or double acting tools

Designed with Safety in Mind:

- Easily adjusted pressure regulator (relief) valve
- 103 bar (1,500 psi) pressure retract relief valve

DESIGNED FOR

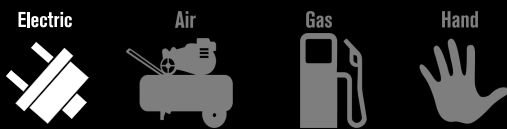

MAINTENANCE
& REPAIR

ORIGINAL
INSTALL

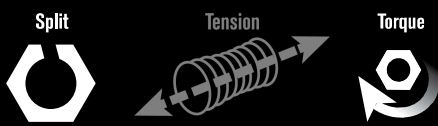

Max
Flow



Specifications and Dimensional Data

Size (L x W x H): 147 cm x 24 cm x 49 cm
18.5" x 9.5" x 19.2"

Weight: 29.5 kg (65 lb) [without oil]

Maximum Oil Capacity: (vented reservoir)
6.8 L (1.8 Gallons) [to fill line]
5.3 L (1.4 Gallons) [usable]

Operating Environment: -25°C to +50°C
(-13°F to +122°F)

(When operating near temperature extremes, it is recommended to use hydraulic oils that are rated for those temperatures. Refer to service manuals and cooling options)

Sound Level: 87-92 dBA (max)

Pressure: 0 - 700 bar (0 - 10,000 psi)

Typical Flow: 11.5 L/min - 0.9 L/min
(704 in³/min - 56 in³/min)

Power: 1-1/8 hp Universal Motor
110/115V - 50/60 Hz (25 amps)
220/230V - 50/60 Hz (13 amps)

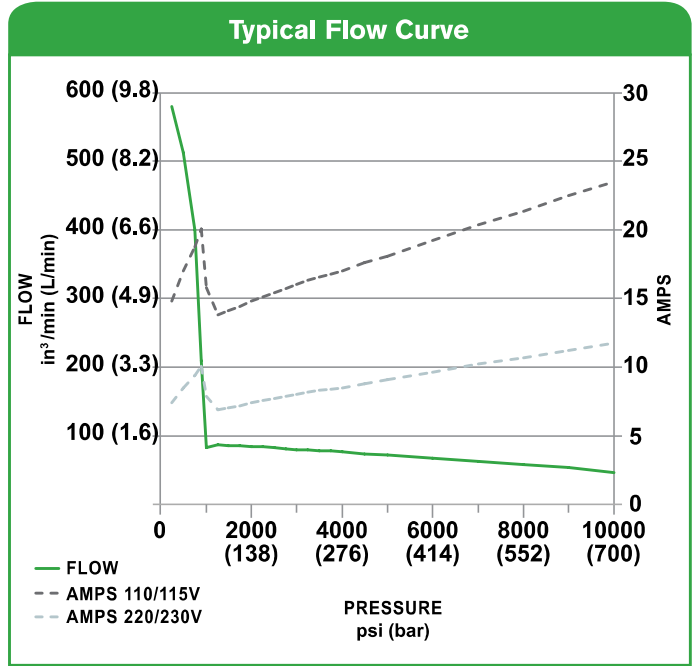

Order No.	Oil Delivery	Oil Reservoir	Usable Oil	Overall Width	Overall Length	Overall Height	Pump Weight w/Oil
	per min.	L (gal)	L (in ³)	mm (in)	mm (in)	mm (in)	kg (lb)
PE55TWP-BS PE55TWP-220-BS	11.5 L/min @ 6.9 bar 704 in ³ @ 100 psi	9.5 (2.5)	5.4 (324)	435 (17.14)	241 (9.5)	460 (18.12)	34 (75)
	0.9 L/min @ 700 bar 56 in ³ @ 10,000 psi						
PE55TWP-4-BS PE55TWP-4-CF-BS PE55TWP-4-220-BS	11.5 L/min @ 6.9 bar 704 in ³ @ 100 psi	9.5 (2.5)	5.4 (324)	470 (18.49)	241 (9.5)	487 (19.15)	35.5 (78)
	0.9 L/min @ 700 bar 56 in ³ @ 10,000 psi						

Electrical Data

	Electric Motor	Electrical Control
PE55TWP-BS PE55TWP-4-BS PE55TWP-4-CF-BS	1-1/8 hp, 12000 rpm 110/150V, 50/60Hz, 25 amps	Remote control with 20-foot cord
PE55TWP-220-BS PE55TWP-4-220-BS	1-1/8 hp, 12000 rpm 220/230V, 50/60Hz, 13 amps	

Ordering Information

Order No.	Description
PE55TWP-BS	110/115V, 50/60 Hz, Single Tool
PE55TWP-4-BS	110/115V, 50/60 Hz, 4 Tool
PE55TWP-4-CF-BS	110/115V, 50/60 Hz, 4 Tool, with Cooling Fan
PE55TWP-220-BS	220/230V, 50/60 Hz, Single Tool
PE55TWP-4-220-BS	220/230V, 50/60 Hz, 4 Tool

Contact factory for CE pump options

LEGACY SERIES ELECTRIC HYDRAULIC PUMP

X1E1-PT
700 bar/10,000 psi



700 BAR (10,000 PSI) CLASSIC SERIES ELECTRIC HYDRAULIC PUMP

The original electric pump! Features a simplified electrical control box and a proven, reliable design. Typically sold to customers that already have a fleet of similar pumps.

Quality means Lower Life-Cycle Costs:

- Over 100,000 cycles
- Continuous duty up to 50°C (122°F) ambient
- Proven design = Proven reliability

Enhanced Usability:

- Power Team, two-speed high performance, PE55 base pump
- Retract side internal relief valve protects tool
- 4-way 2-position solenoid valve standard
- Use with single or double acting tools, not for lifting applications
- Hand remote standard

Designed with Safety in Mind:

- Easily adjusted pressure regulator (relief) valve
- Fixed 103 bar (1,500 psi) pressure retract relief valve

DESIGNED FOR

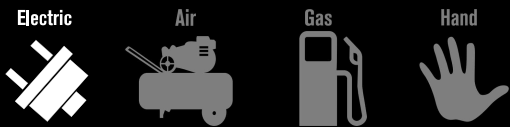

MAINTENANCE & REPAIR

ORIGINAL INSTALL

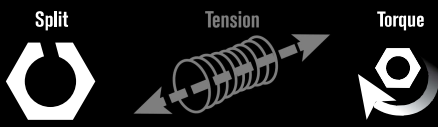

Max Flow



Specifications and Dimensional Data

Size (L x W x H): 35 cm x 33 cm x 46 cm
13.9" x 13.1" x 18.1"

Weight: 35.3 kg (78 lb) [without oil]

Maximum Oil Capacity: (vented reservoir)
6.8 L (1.8 Gallons) [to fill line]
5.3 L (1.4 Gallons) [usable]

Operating Environment: -25°C to +50°C
(-13°F to +122°F)

(When operating near temperature extremes, it is recommended to use hydraulic oils that are rated for those temperatures. Refer to service manuals and cooling options)

Sound Level: 87-92 dBA (max)

Pressure: 0 - 700 bar (0 - 10,000 psi)

Typical Flow: 11.5 L/min - 0.9 L/min
(704 in³/min - 55 in³/min)

Power: 1-1/8 hp Universal Motor
110/115V - 50/60 Hz (25 amps)
220/230V - 50/60 Hz (13 amps)

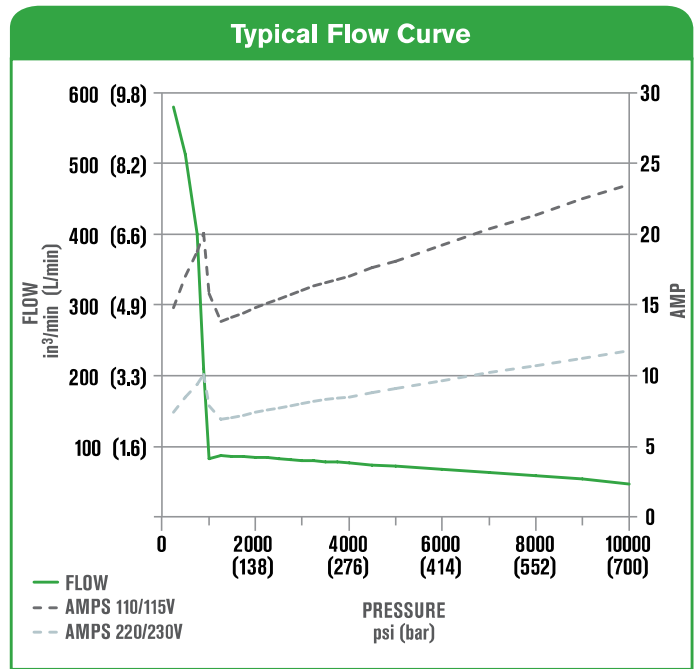

Order No.	Oil Delivery	Oil Reservoir	Usable Oil	Overall Width	Overall Length	Overall Height	Pump Weight w/Oil
	per min.	L gal	L in ³	cm in	cm in	cm in	kg lb
X1E1-PT	0.9 L @ 700 bar	9.5	5.3	35	33	46	41
	55 in ³ @ 10,000 psi	2.5	324	13.9	13.1	18.1	90

Electrical Data

	Electric Motor	Electrical Control
X1E1-PT	1-1/8 hp, 12000 rpm 110/115V, 50/60 Hz, 25 amps	Remote control with 6 meter (20-foot) cord

Ordering Information

Order No.	Description
X1E1-PT	110/115V, 50/60 Hz, Single Tool
X1E2-PT	220/230V, 50/60 Hz, Single Tool

CLASSIC SERIES GAS HYDRAULIC PUMP

PG120TWP
700 bar/10,000 psi

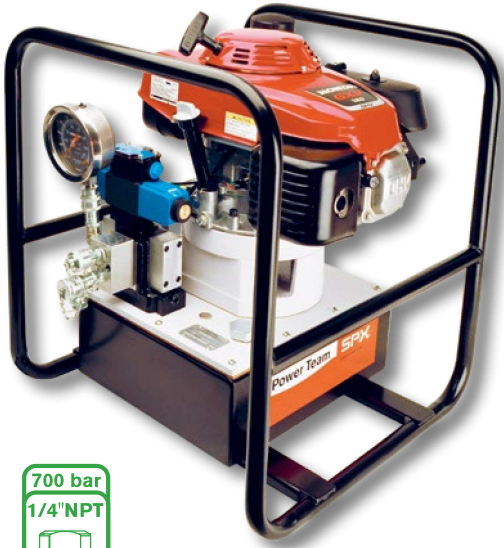

700 BAR (10,000 PSI) CLASSIC SERIES GAS HYDRAULIC PUMP

Gasoline powered pump for use in remote locations where electricity or compressed air are not readily available.

Operates on a powerful 5.5 hp Honda OHV-type engine.

Quality means Lower Life-Cycle Costs:

- High quality, reliable gasoline engine
- Continuous duty
- Proven design = proven reliability

Enhanced Usability:

- Air cooled 4-stroke engine
- Uses standard unleaded gasoline
- Large capacity, multi-chamber exhaust system to reduce noise

Designed with Safety in Mind:

- Fixed 48 bar (700 psi) Unload Valve
- Frame allows for easy two man carry

DESIGNED FOR

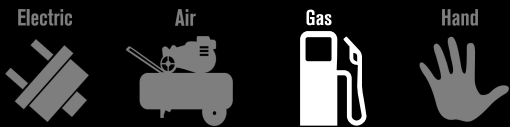

MAINTENANCE & REPAIR

ORIGINAL INSTALL



Max Flow



Specifications and Dimensional Data

Size (L x W x H): 54 cm x 50 cm x 59 cm
21.25" x 19.75" x 23"

Weight: 55 kg (121 lb) [without oil]

Maximum Oil Capacity: (vented reservoir)
10.2 L (2.7 Gallons) [to fill line]
9.4 L (2.5 Gallons) [usable]

Operating Environment: -25°C to +50°C
(-13°F to +122°F)

(When operating near temperature extremes, it is recommended to use hydraulic oils that are rated for those temperatures. Refer to service manuals and cooling options)

Sound Level: 85-92 dBA (max)

Pressure: 0 - 700 bar (0 - 10,000 psi)

Typical Flow: 7.87 L/min - 2.13 L/min
(480 in³/min - 130 in³/min)

Power: 5.5 hp Honda OHV-Type Gasoline Engine, 3600 rpm

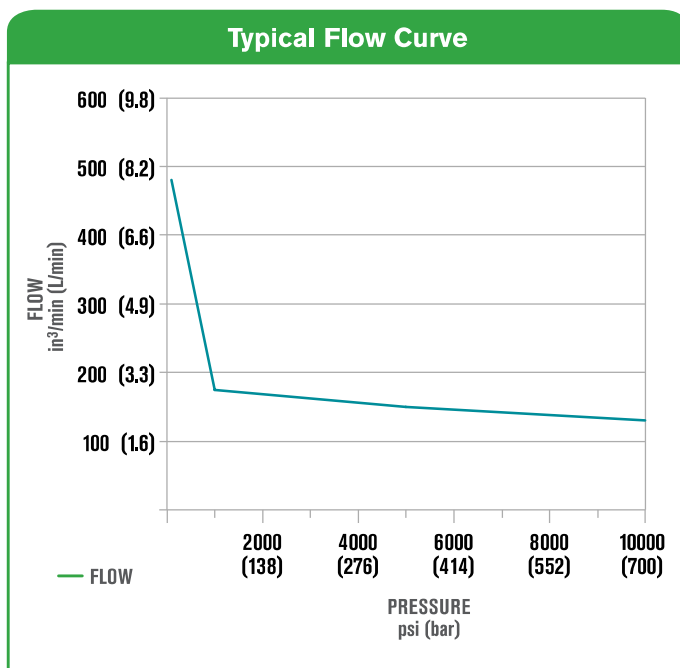

Order No.	Oil Delivery	Oil Reservoir	Usable Oil	Overall Width	Overall Length	Overall Height	Pump Weight w/Oil
	per min.	L gal	L in ³	cm in	cm in	cm in	kg lb
PG120TWP	7.87 L/min @ 7 bar 2.13 L/min @ 700 bar	11.4	9.4	50	54	59	57.2
	480 in ³ @ 100 psi 130 in ³ @ 10,000 psi	3	572	19.75	21.25	23	126

Ordering Information

Order No.	Description
PG120TWP	Gasoline Pump, Single Tool

CLASSIC SERIES AIR HYDRAULIC PUMP

RWP55-BS
700 bar/10,000 psi



700 BAR (10,000 PSI) CLASSIC SERIES AIR HYDRAULIC PUMP

The RWP55-BS has been the market leading pump for over 30 years & is therefore tried & tested. A simple, light-weight design with a recent upgrade that has created a cost-effective workhorse.

Quality means Lower Life-Cycle Costs:

- Over 100,000 cycles
- Continuous duty up to 50°C (122°F) ambient
- Proven design = Proven reliability

Enhanced Usability:

- Powerful 3 hp motor starts under load
- Retract side internal relief valve protects tool
- Use with single or double acting tools. Not for lifting applications
- 4" calibration capable gauge

Designed with Safety in Mind:

- Easily adjusted pressure regulator (relief) valve
- Has a retract port pressure selector 103 or 700 bar (1,500 or 10,000 psi)

DESIGNED FOR

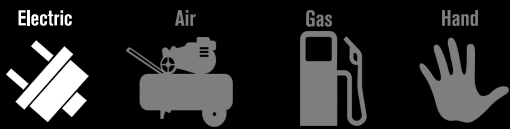

MAINTENANCE & REPAIR

ORIGINAL INSTALL



Max Flow



Specifications and Dimensional Data

Size (L x W x H): 42 cm x 24 cm x 50 cm
16.6" x 9.5" x 19.8"

Weight: 38 kg (84 lb) [without oil]

Maximum Oil Capacity: (vented reservoir)
6.8 L (1.8 Gallons) [to fill line]
5.3 L (1.4 Gallons) [usable]

Operating Environment: -25°C to +50°C
(-13°F to +122°F)

(When operating near temperature extremes, it is recommended to use hydraulic oils that are rated for those temperatures. Refer to service manuals and cooling options)

Sound Level: 85-92 dBA (max)

Pressure: 0 - 700 bar (0 - 10,000 psi)

Typical Flow: 7.6 L/min - 0.9 L/min
(465 in³/min - 55 in³/min)

Air: 1.4 m³/min @ 5.5 bar (50 cfm @ 80 psi)
1.65 m³/min @ 6.2 bar (58 cfm @ 90 psi)
1.89 m³/min @ 6.9 bar (67 cfm @ 100 psi)

* Values shown are with filter/regulator/lubricator.
Values will increase without filter/regulator/
lubricator.

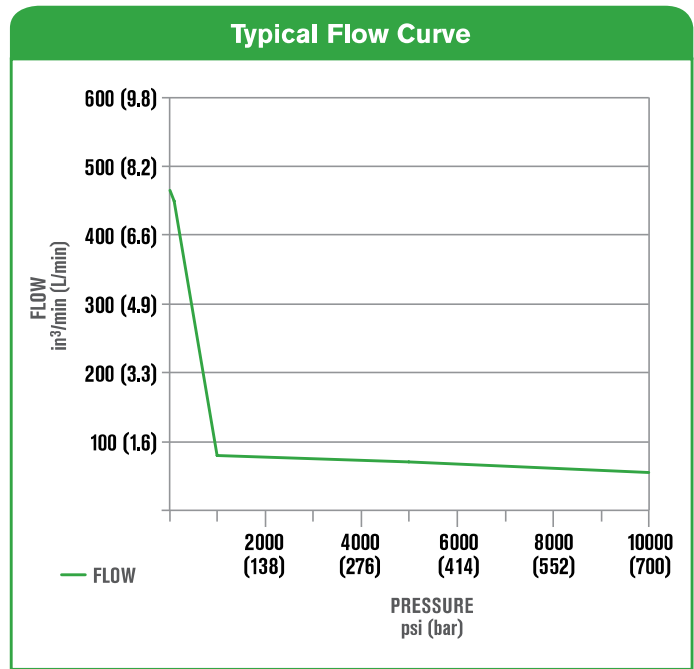

Order No.	Oil Delivery	Oil Reservoir	Usable Oil	Overall Width	Overall Length	Overall Height	Pump Weight w/Oil
	per min	L (gal)	L (in ³)	mm (in)	mm (in)	mm (in)	kg (lb)
RWP55-BS	7.6 L @ 7 bar 0.9 L @ 700 bar	9.5 (2.5)	5.3 (324)	420 (16.55)	241 (9.5)	503.7 (19.83)	44 (98)
	465 in ³ @ 100 psi 55 in ³ @ 10,000 psi						
RWP55-4-BS (4-tool manifold)	7.6 L @ 7 bar 0.9 L @ 700 bar	9.5 (2.5)	5.3 (324)	420 (16.55)	241 (9.5)	503.7 (19.83)	44 (98)
	465 in ³ @ 100 psi 55 in ³ @ 10,000 psi						

Motor Data

	Air Motor	Air Control
RWP55-BS	1.4 m ³ /min @ 5.5 bar 3 hp, 50 cfm @ 80 psi	Pneumatic remote control with 6 meter (25-foot) cord

Ordering Information

Order No.	Description
RWP55-BS	Air Pump, Single tool
RWP55-BS-R	Air Pump, Single tool, with roll cage
RWP55-4-BS	Air Pump, 4 tool
RWP55-4-BS-R	Air Pump, 4 tool, with roll cage

LEGACY SERIES AIR HYDRAULIC PUMP

X1A1-PT
700 bar/10,000 psi



700 BAR (10,000 PSI) CLASSIC SERIES AIR HYDRAULIC PUMP

The original air pump! Features a proven, reliable design. Typically sold to customers that already have a fleet of similar pumps.

Quality means Lower Life-Cycle Costs:

- Over 100,000 cycles
- Continuous duty up to 50°C (122°F) ambient
- Proven design = Proven reliability

Enhanced Usability:

- Power Team, two-speed high performance, PA55 base pump
- Retract side internal relief valve protects tool
- 4-way 2-position air pilot valve standard
- Use with single or double acting tools. Not for lifting applications.
- Hand remote standard

Designed with Safety in Mind:

- Easily adjusted pressure regulator (relief) valve
- Fixed 103 bar (1,500 psi) pressure retract relief valve

DESIGNED FOR

Electric



Air



Gas



Hand



MAINTENANCE
& REPAIR

ORIGINAL
INSTALL

Split



Tension



Torque



Max
Flow



Specifications and Dimensional Data

Size (L x W x H): 27 cm x 46 cm x 48 cm
10.8" x 18" x 18.8"

Weight: 34 kg (75 lb) [without oil]

Maximum Oil Capacity: (vented reservoir)
6.8 L (1.8 Gallons) [to fill line]
5.3 L (1.4 Gallons) [usable]

Operating Environment: -25°C to +50°C
(-13°F to +122°F)

(When operating near temperature extremes, it is recommended to use hydraulic oils that are rated for those temperatures. Refer to service manuals and cooling options)

Sound Level: 85-92 dBA (max)

Pressure: 0 - 700 bar (0 - 10,000 psi)

Typical Flow: 7.6 L/min - 0.9 L/min
(465 in³/min - 55 in³/min)

Air: 1.4 m³/min @ 5.5 bar (50 cfm @ 80 psi)
1.65 m³/min @ 6.2 bar (58 cfm @ 90 psi)
1.89 m³/min @ 6.9 bar (67 cfm @ 100 psi)

* Values shown are with filter/regulator/lubricator.
Values will increase without filter/regulator/lubricator.

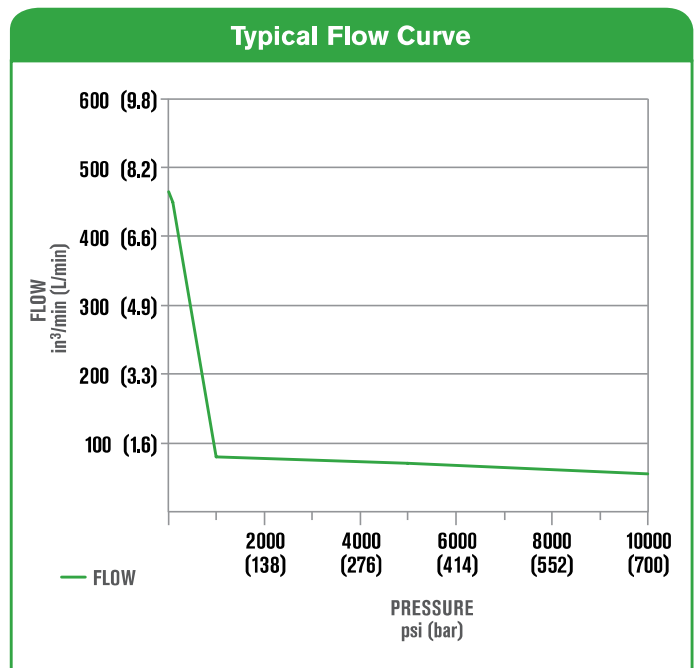

Order No.	Oil Delivery	Oil Reservoir	Usable Oil	Overall Width	Overall Length	Overall Height	Pump Weight w/Oil
	per min	L (gal)	L (in ³)	mm (in)	mm (in)	mm (in)	kg (lb)
X1A1-PT	7.6 L @ 7 bar 0.9 L @ 700 bar	9.5 (2.5)	5.3 (324)	273 (10.75)	457 (18)	476 (18.75)	40 (89)
	465 in ³ @ 100 psi 55 in ³ @ 10,000 psi						

Ordering Information

Order No.	Description
X1A1-PT	Air Pump, Single tool

HAND PUMPS HYDRAULIC P SERIES

700 bar/10,000 psi



P59L



P19

PUMP AUTOMATICALLY SHIFTS INTO THE HIGH PRESSURE STAGE UPON CONTACT WITH THE LOAD.

- All metal construction won't burn through in welding environments.
- Two-speed reduces handle strokes so you work faster and easier.
- Convenient fill port allows pumps to be filled in a horizontal or vertical position.
- Relief valve inboard of check valve prevents loads from drifting down.
- Large valve knob gives added control for slowly metering loads down.

P19L/P59L

- More usable oil volume — use with larger or longer stroke cylinders.
- True unloading valve set for 59 bar (850 psi) provides more efficiency and lower handle force.
- Link design reduces handle effort by 40%.
- Durable aluminum reservoir, manifold, and end cap.
- Ergonomic non-slip handle grip provides more comfort.
- Spring loaded handle lock incorporated into handle.

P19/P59/P59F

- Steel reservoir
- Strong lever
- Lower handle effort (measured)
- Higher unloading pressure 22 bar (325 psi)
- Pump is serviceable (all components available)
- Durable aluminum pump head
- No breather opening needed (so no leakage)
- True unloading (more flow/ lower effort)
- Pump mounting holes on front and back
- Solid accurate repeatable Integrated lifting system
- Can be used in welding environment (no plastic)

DESIGNED FOR

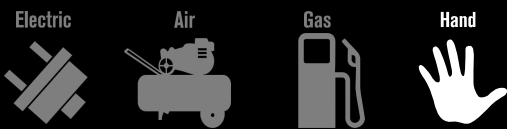

MAINTENANCE & REPAIR

ORIGINAL INSTALL

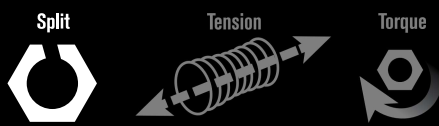

Max Flow



No coupler included with these pumps.

Specifications and Dimensional Data

Operating Environment: -25°C to +50°C
(-13°F to +122°F)

(When operating near temperature extremes, it is recommended to use hydraulic oils that are rated for those temperatures. Refer to service manuals and cooling options)

Pressure: 0 - 700 bar (0 - 10,000 psi)

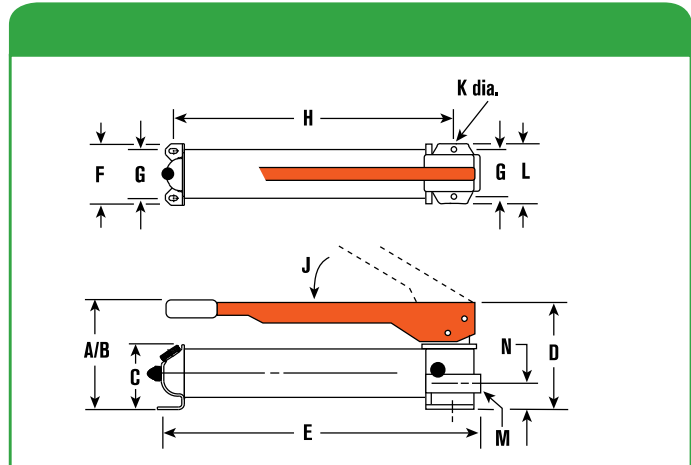

Order No.	A mm in	B mm in	C mm in	D mm in	E mm in	F mm in	G mm in	H mm in	J deg	K mm in	L mm in	M in	N mm in
P19	476	371	73	116	348	102	83	281	53°	8	102	3/8 NPTF	36
	5-1/2	14-5/8	2-7/8	4-9/16	13-11/16	4	3-1/4	11-1/16	53°	5/16	4	3/8 NPTF	1-13/32
P19L	476	-	-	-	348	105	83	279	40°	8	-	3/8 NPTF	-
	5-1/2	-	-	-	13-11/16	4-1/8	3-1/4	11	40°	5/16	-	3/8 NPTF	-
P59	178	533	89	127	584	114	89	502	38°	8	121	3/8 NPTF	41
	7	21	3-1/2	5	23	4-1/4	3-1/4	19-3/4	38°	5/16	4-3/4	3/8 NPTF	1-5/8
P59L	178	-	-	-	533	127	83	502	50°	8	-	3/8 NPTF	-
	7	-	-	-	21	5	3-1/4	19-3/4	50°	5/16	-	3/8 NPTF	-
P59F	89	425	89	152	591	114	83	514	-	8	114	3/8 NPTF	-
	3-1/2	16-3/4	3-1/2	6	23-1/4	4-1/4	3-1/4	20-1/4	-	5/16	4-1/2	3/8 NPTF	-

Ordering Information

For Use With	Order No.	Speed	Volume & Pressure								Reservoir Handle Effort		Oil Capacity		Usable Oil Capacity		Oil Port	Product Weight	
			Volume per Stroke				Maximum Pressure												
			LP	HP	LP	HP	LP	HP	LP	HP	(kg)	(lb)	(cm³)	(in³)	(cm³)	(in³)	(in)	(kg)	(lb)
Single Acting	P19	2	5.0	0.305	1.2	0.076	22	325	700	10,000	45	99	400	24.4	328	20	3/8 NPTF	3.0	6.6
	P19L	2	4.1	0.250	0.8	0.050	59	850	700	10,000	35	78	475	29	443	27	3/8 NPTF	2.3	5.1
	P59	2	10.8	0.662	2.6	0.160	22	325	700	10,000	66	145	901	55	737	45	3/8 NPTF	7.8	17.2
Tools & Cylinders*	P59L	2	12.0	0.720	2.5	0.150	59	850	700	10,000	47	104	1131	69	1082	66	3/8 NPTF	4.0	8.9
	P59F	2	9.0	0.550	2.1	0.130	22	325	700	10,000	54	120	901	55	737	45	3/8 NPTF	6.4	14

LP = Low Pressure
HP = High Pressure
*Pump includes 2-Way Valve



Foot Pump Conversion Kit

No. FK59 - Foot pump conversion kit for use on P55/P59 pumps. Wt., 2.7 kg (6 lb)